

Watchman W480 Installation Guide

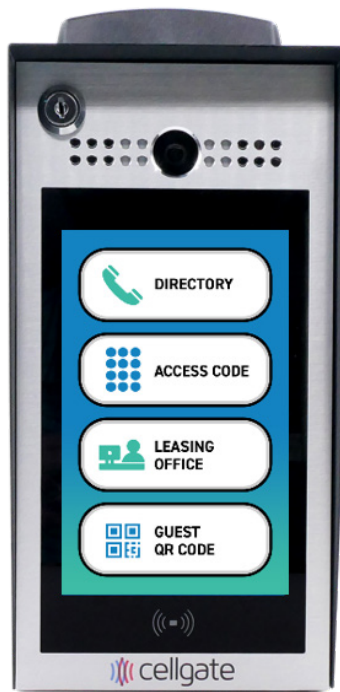

Created March 2025





Contents

Items Included.....	3
Standard Power Wiring.....	4
Unit Overviews	
Cellular.....	5
InHand Router.....	6
VPN.....	8
Internet.....	9
Wiring	
Blue Board.....	10
Wiegand.....	11
Gate Status from a Gate Operator.....	11
Dry Contact Relay, Normally Open.....	12
Dry Contact Relay, Normally Closed.....	12
Wet Contact Relay, Normally Open.....	13
Wet Contact Relay, Normally Closed.....	13
Expansion Boards Overview.....	14
Expansion Boards Detail.....	15
Relay Operation Configuration.....	16
Mounting to a Standard Pedestal.....	17

Remove plastic covering from the W480 screen before installation.





Items Included

- Watchman 480 Unit (or W480 2X)
- Blue Board
- Connection Device: Ethernet Switch and InHand Router (cellular), Router (internet), VPN (internet)
- Optional: 2 Expansion Boards
- 12 Volt DC Power Supply
- Keys
- Flangenuts 1/4" (x4)
- Carriage Bolts 1/4" x 1" (x4)
- Customer Information Packet

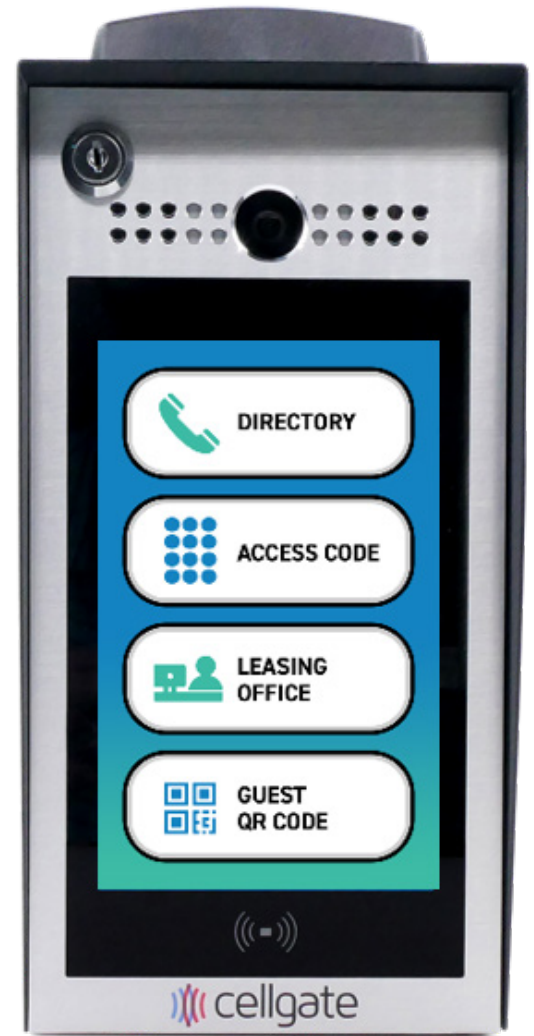

Wiring Guidelines

Gauge Wire	Wire Run
18	25 feet
16	50 feet
12	60 feet

We do not recommend running wires over 60 feet.

Required wiring:

6 conductor stranded and shielded for main device, and 4 conductor stranded and shielded for optional Wiegand devices.

Pay attention to polarity.
The system uses DC power.



Operating Temperatures

-20° to 55° C
-4° to 131° F



Standard Power Wiring

Most devices will be powered using the (PWR-200) 12V DC 5 Amp Transformer.

Ensure you wire the positive to the + and negative to the -

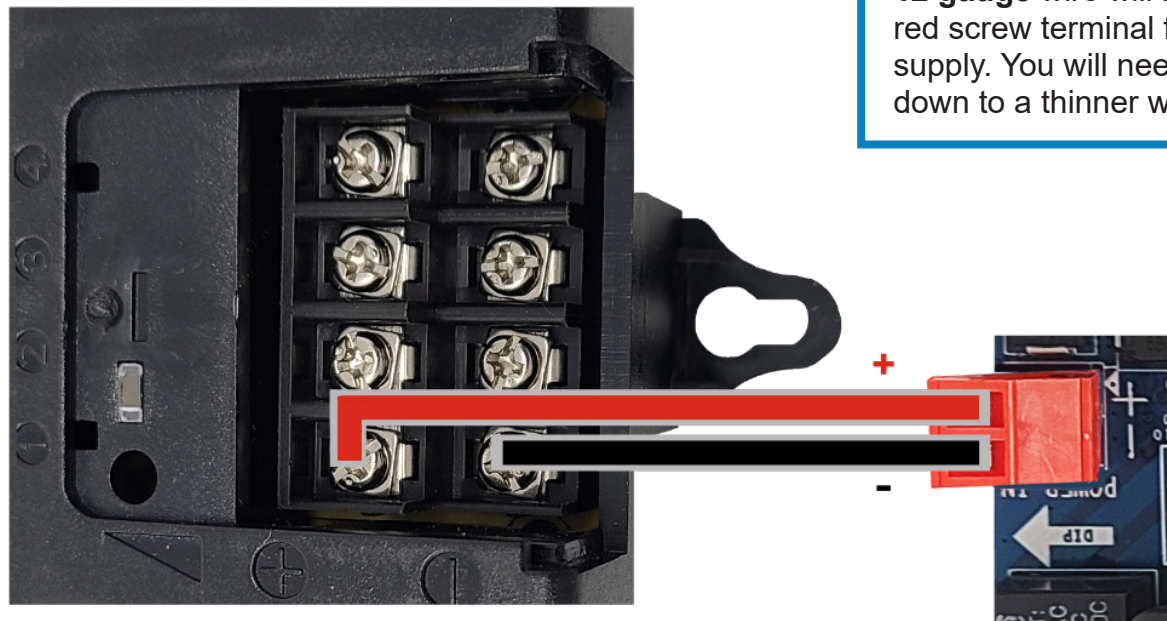

12 gauge wire will not fit in the red screw terminal for the power supply. You will need to splice it down to a thinner wire.



Use the Type-B grounded plug that is supplied with the transformer.



For solar power wiring instructions, please contact CellGate.



Unit Overview: W480 Cellular

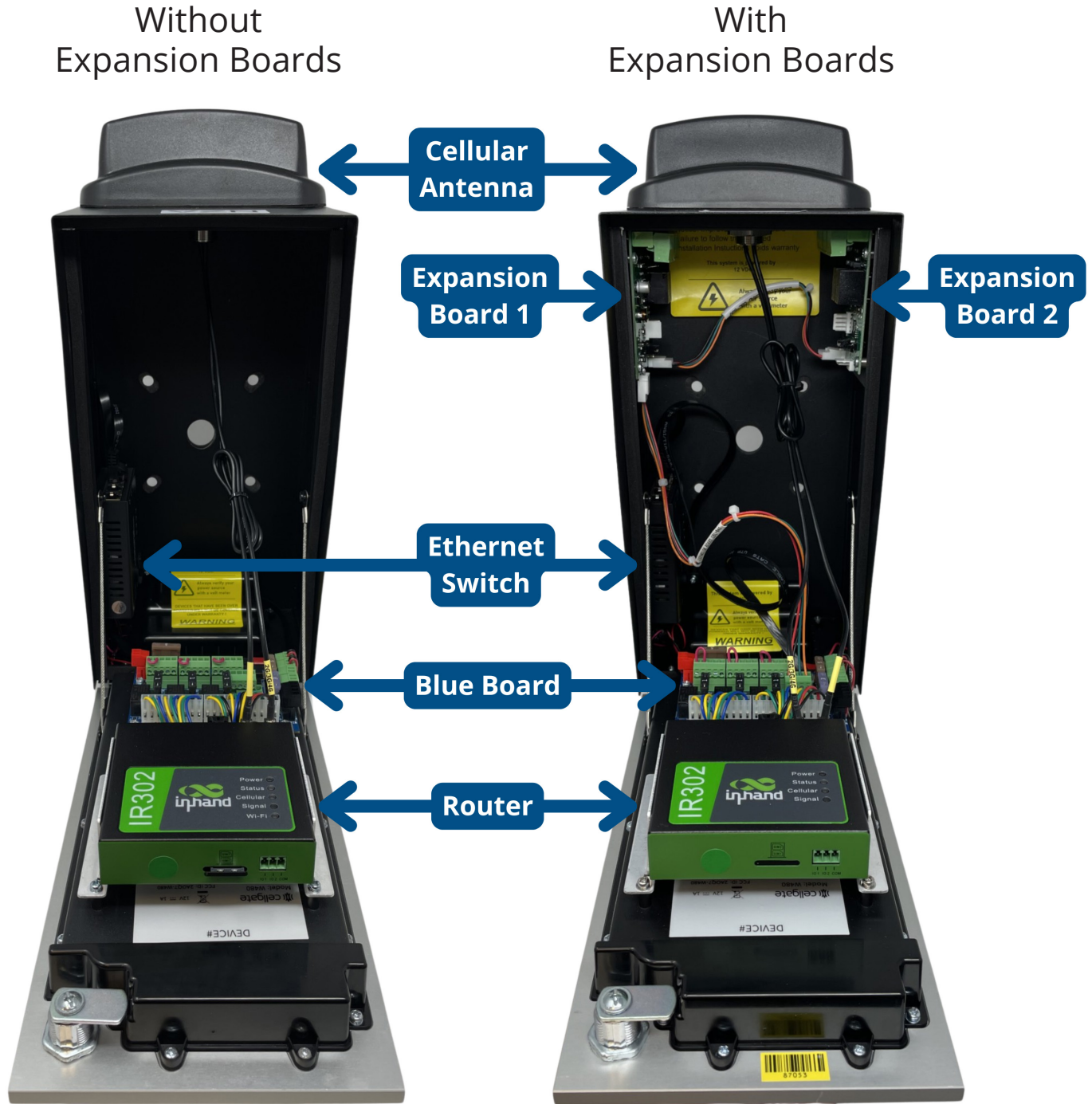



InHand Router

For Use in W480 Version: AA1MLPE-ATT / AA1MLPE-VZN / AA1MLPE-2X-ATT / AA1MLPE-2X-VZN
 Product ID: M780



Power: Indicates the device is on
Status: Indicates device state/troubles
Cellular: Indicates device communication
Signal: Indicates strength of signal

Power	Status	Cellular	Description
Off	Off	Off	Powered Off
On	Off	Off	System Failure
On	On	Off	Module or SIM Card Not Recognized
On	On	Blinking	Dialing
On	On	On	Dialing Success
On	Blinking	On	Upgrading
On	Blink > On	On	Reset

Signal	Description
Red	Signal 0 - 10 (Bad)
Yellow	Signal 11 - 20 (Decent)
Green	Signal 21 - 30 (Good)



Not for use with this device

Do not remove the SIM card tray unless specifically advised by tech support.

The SIM card tray contains both AT&T and Verizon SIM cards. They can only be swapped online by tech support.

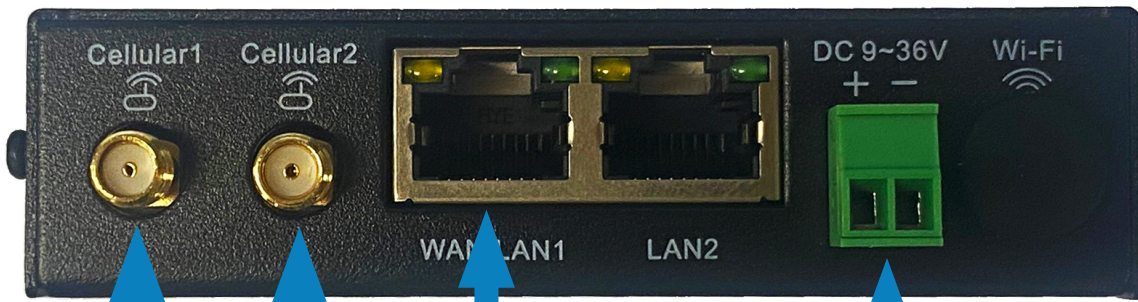

Cellular 1 & 2:
Directly connected to antenna

WAN / LAN1: Plugs into the ethernet switch

Power Block: 12V DC is applied from the blue board

Activity	Description
Off	No Network Connection
On	Network Connection
Blinking	Network Activity

Speed	Description
Off	No Cell Connection
On	Cell Connection
Blinking	Cell Activity

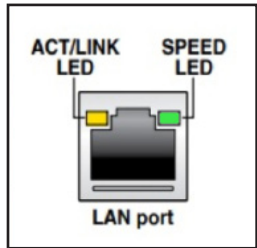



Unit Overview: W482 VPN

VPN does not support external cameras.

Without Expansion Boards

With Expansion Boards

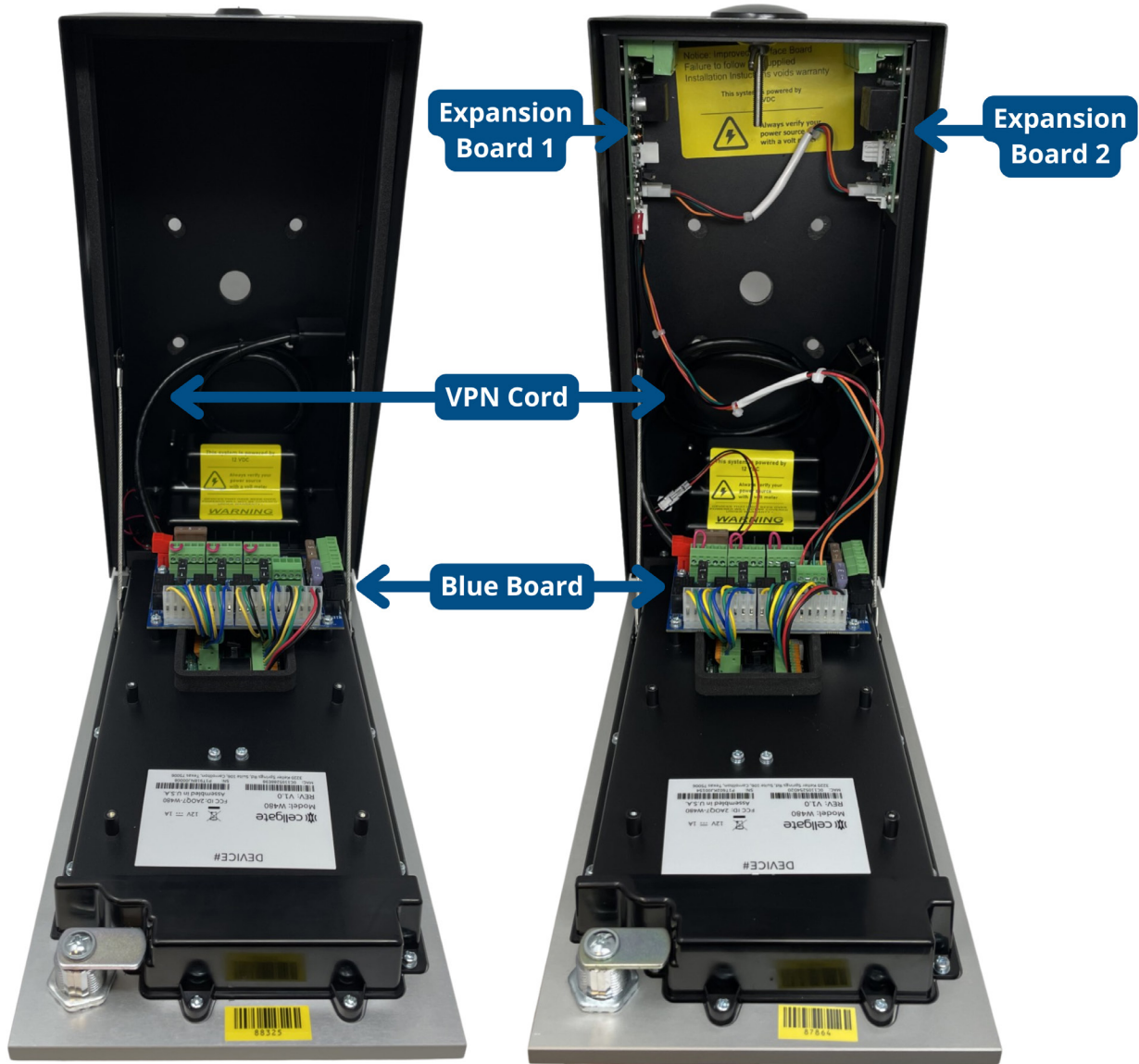

VPN Cord

For Use in W482 Version:

AA1MLPE-VPN / AA1MLPE-2X-VPN



W482 requires internet throughput of at least 1.5 megabytes per second.



Unit Overview: W480 Internet

Internet router supports external cameras.

Without
Expansion Boards

With
Expansion Boards

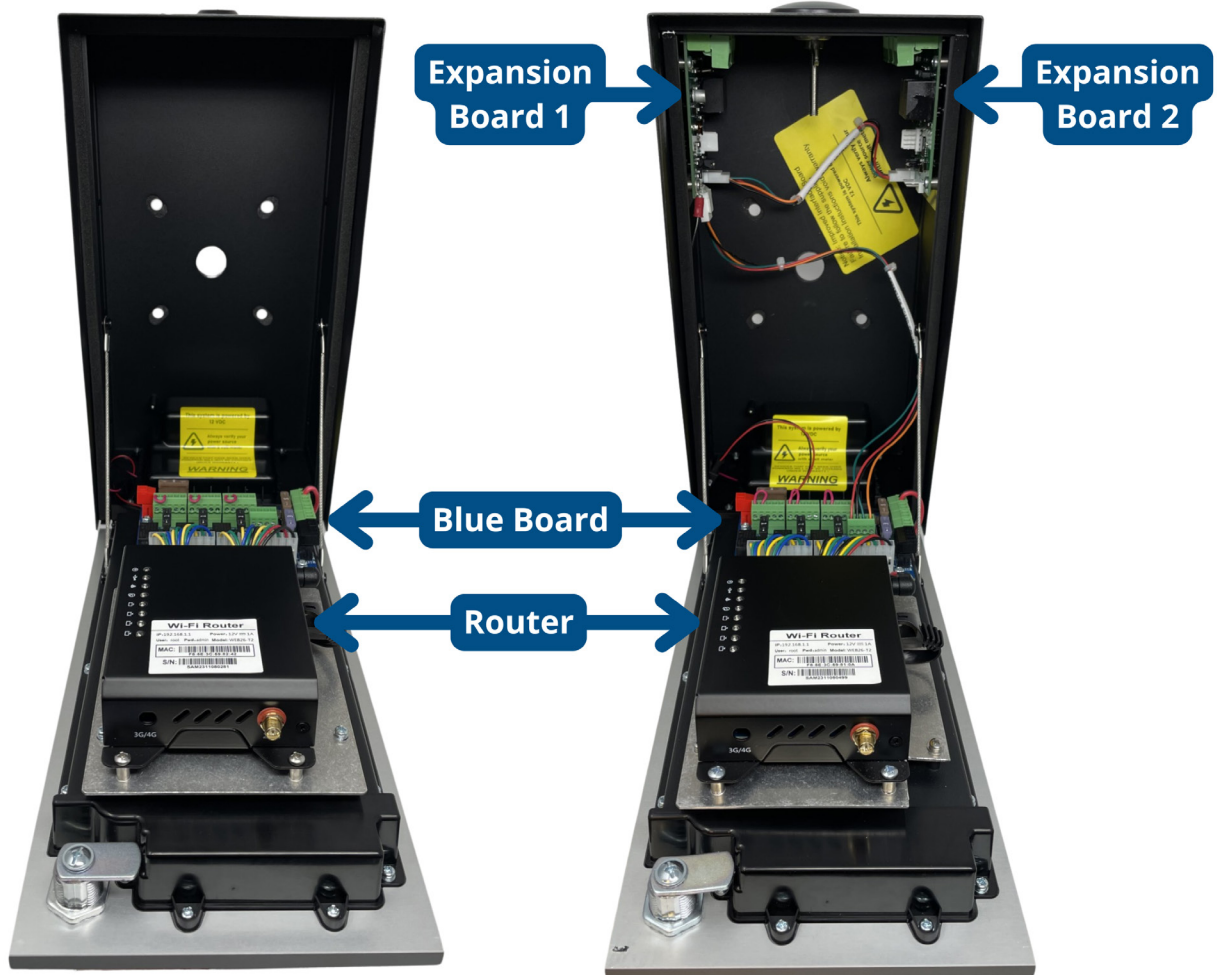

Router

For Use in W480 Version:

AA1MLPE-INT / AA1MLPE-2X-INT

Product ID: M730



- ← Plug customer's Internet into the blue port.
- ← Plug Watchman into any yellow port.
- ← Plug optional external cameras into any yellow port.

W480 requires internet throughput of at least 1.5 megabytes per second.



Blue Board

Below is the blue board inside the device. It provides power to the router and other accessories, such as cameras. It's also the central control interface between the faceplate and the router.

- Wire main power from transformer to the power connector on the blue board.
- Connect gate trigger wires from the Normally Open (NO) and Common (C) to the free exit or exit terminals on the gate operator.
- Connect the gate status wires on the 5-pin connector on the main relay and input plug to the magnetic switch or Dry Contact, Normally Closed (NC) relay on the gate operator.
- If using an optional 26-bit reader (keypad, card reader, RFID, or clicker), wire the device to the Wiegand connection on the blue board.
- Use the camera guide if adding an optional external camera.

Activate using test credentials on the Activation and Test Process document.

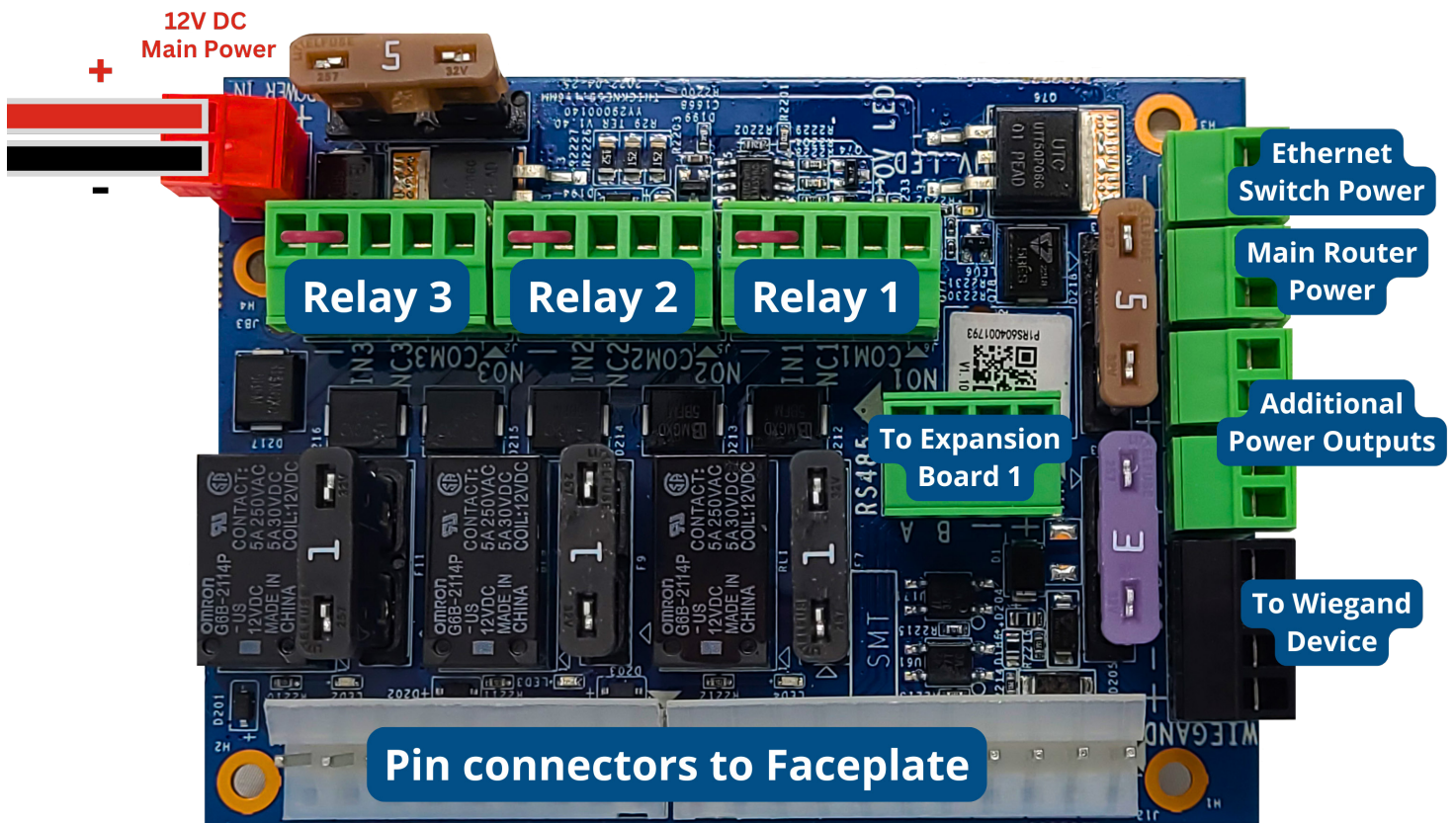



Wiegand Wiring

Wiegand Device

D1 D0 - +



Gate Status from a Gate Operator

You can monitor the status of the gate by wiring a dry contact output from the gate operator into an input on the blue board. You will likely need to program the output of the gate operator.

Gate Lock or Status

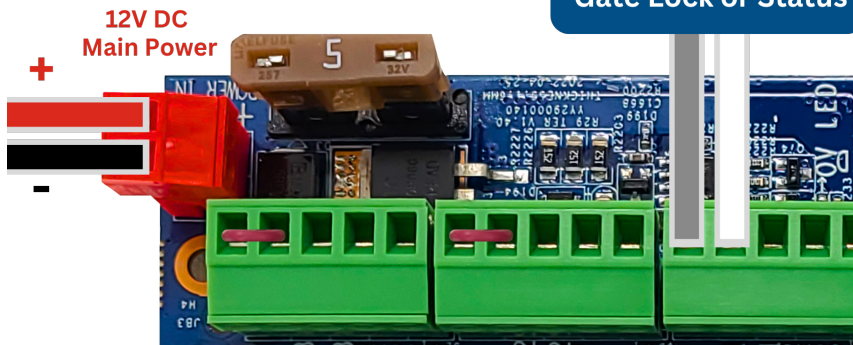

Warning: You must wire into a **DRY CONTACT** on the Gate Operator. Applying power to the input on the blue board will damage it.

Gate statuses can be inverted. If needed, please call CellGate to invert.

RELAY

- INPUT - ○
- INPUT + ○
- NC
(Normally Closed) ○
- COMMON ○
- NO
(Normally Open) ○

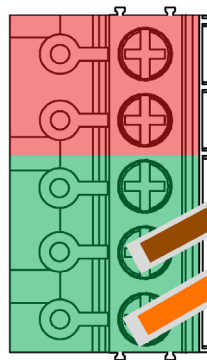

LOOPS

- EXIT
- SHADOW
- INTERRUPT

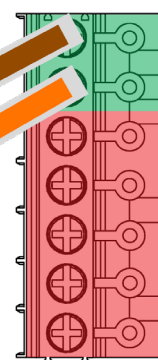



Dry Contact Relay, Normally Open

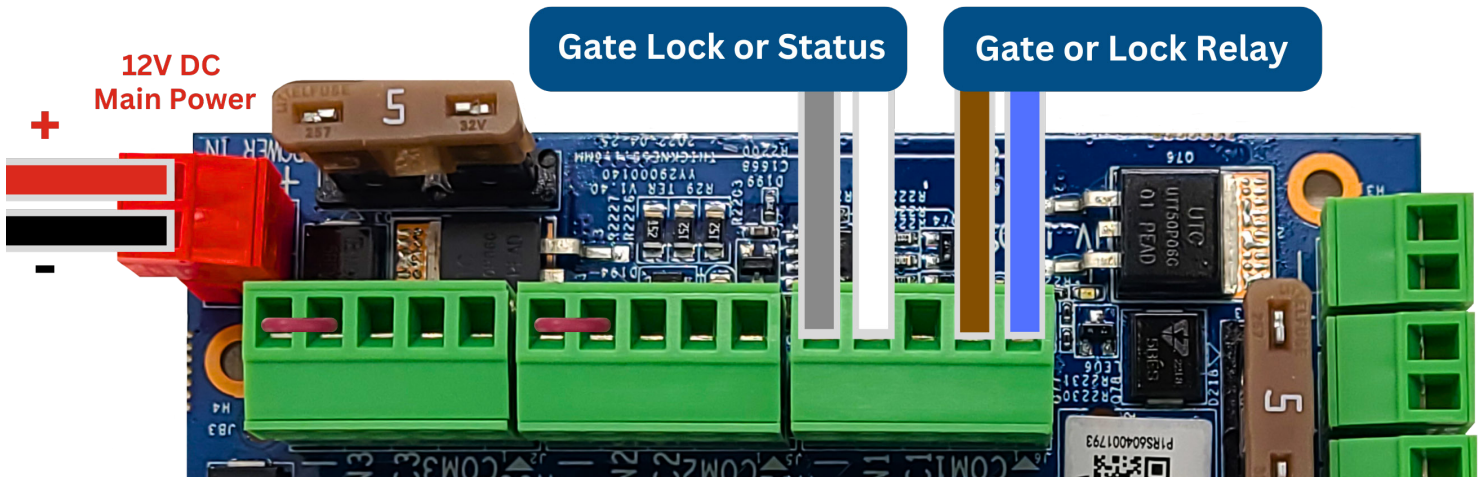

Dry Contact Relay, Normally Closed

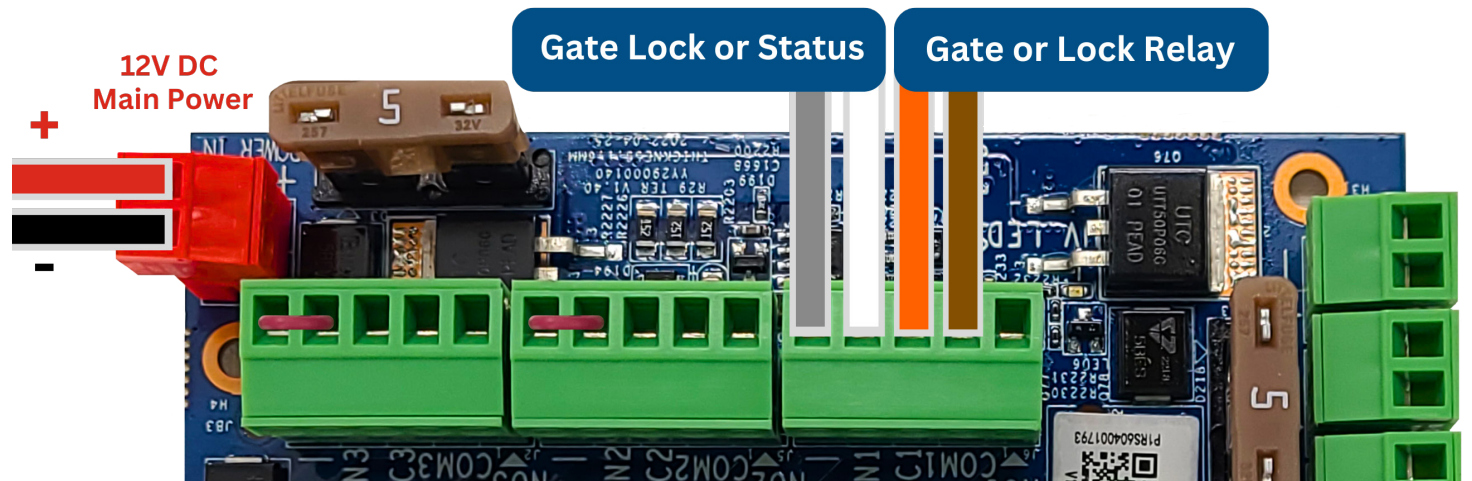



! You must use a diode to maintain warranty. Contact CellGate for diode instructions.

Wet Contact Relay, Normally Open

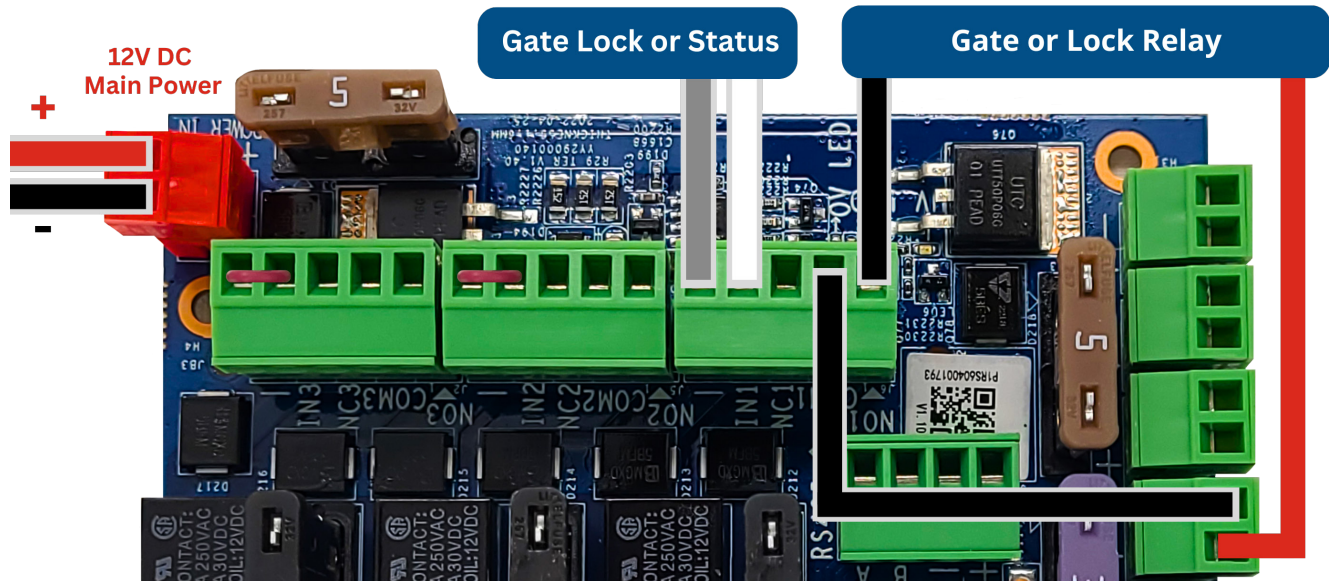

Wet Contact Relay, Normally Closed

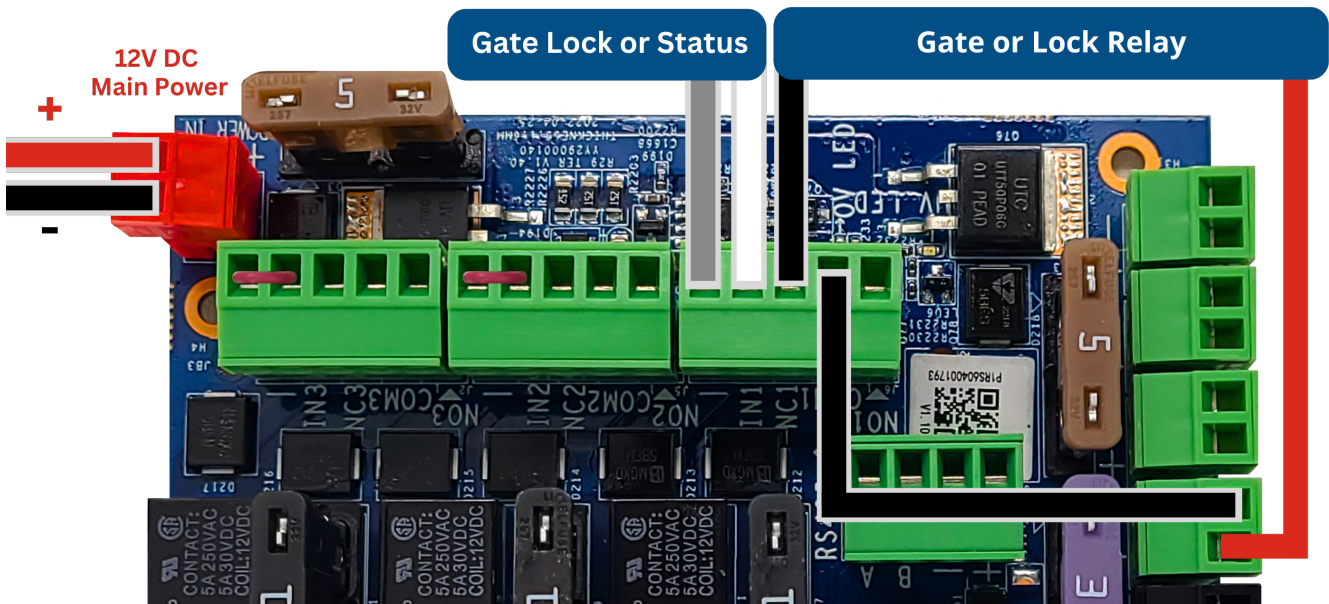



Expansion Boards Overview

In addition to the blue board, the W480 2X has two expansion boards. Each expansion board has:

- 2 additional relays
- 2 additional inputs
- 1 additional Wiegand connection

The expansion boards come pre-wired to the blue board's RS485 port as shown below.

Expansion Board 1 Left

Expansion Board 2 Right

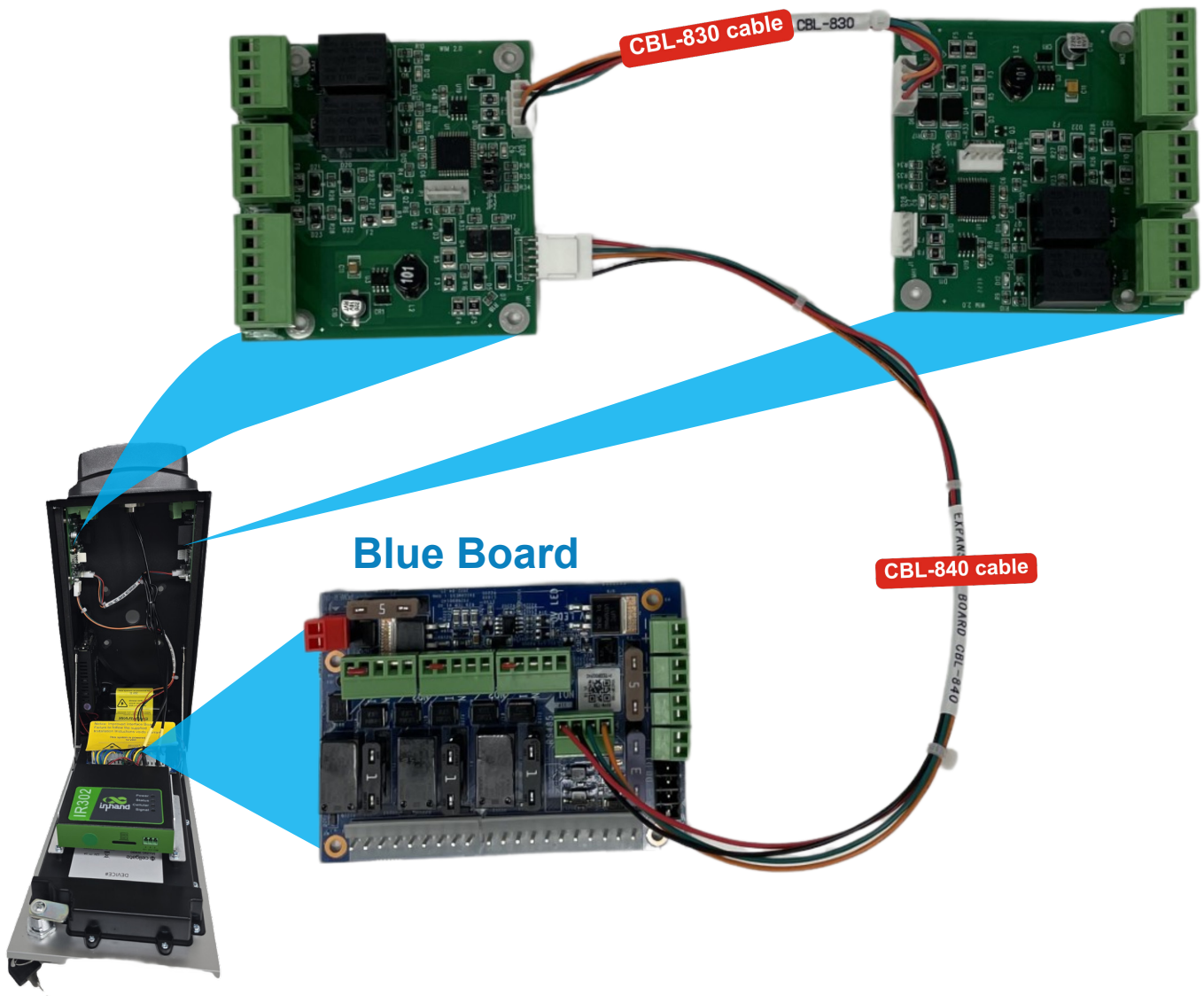



Expansion Boards Detail

The jumpers on each expansion will be pre-configured as shown below. **Do not change jumper configurations.**

The relay wiring on each of the expansion boards is shown below. Note: This is different from the blue board configuration.

The Wiegand connection on the expansion board is shown below and is the same as the blue board.

Relay configuration for Normally Open or Normally Closed is shown on the next page.

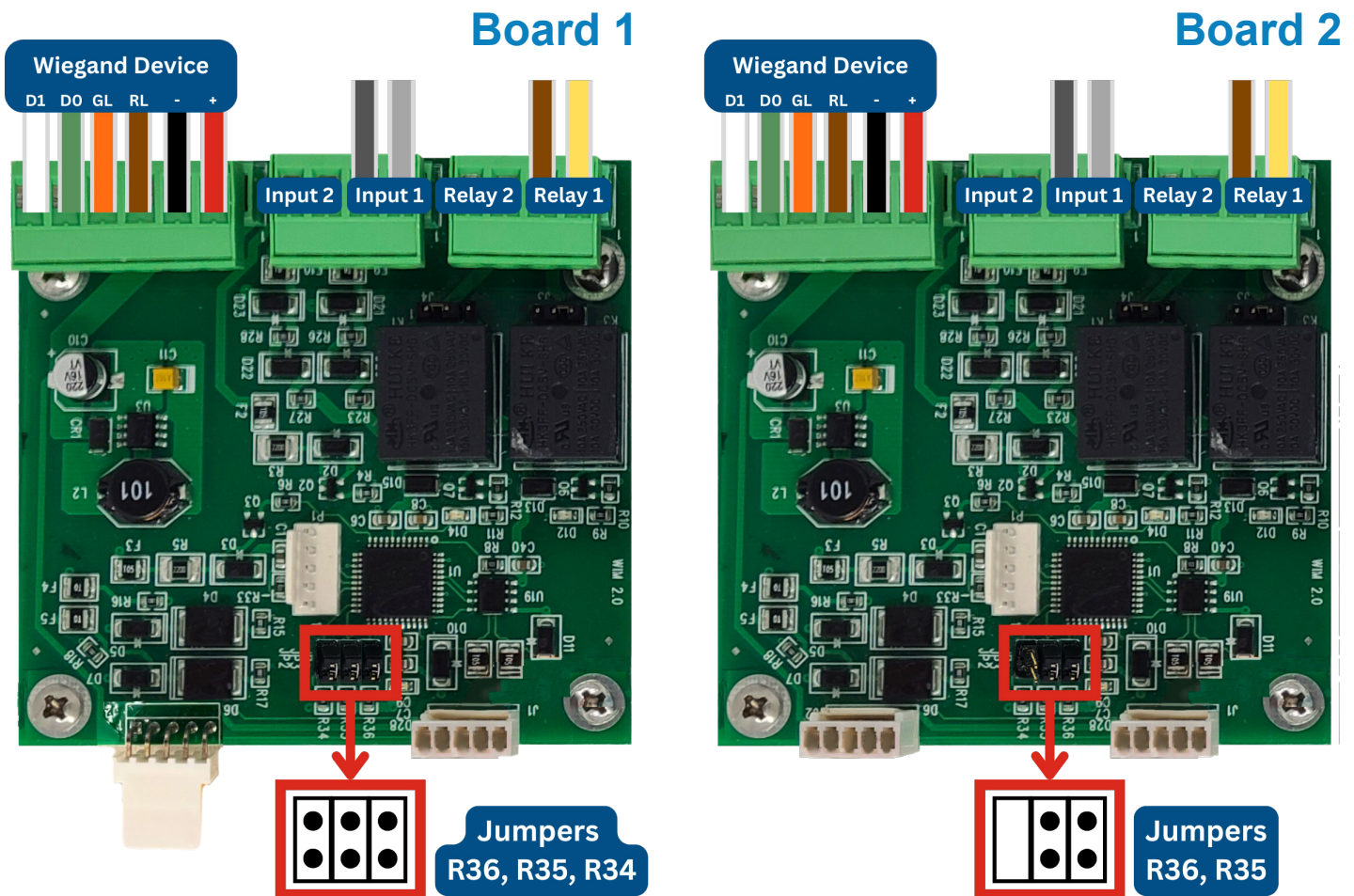

A flashing yellow light will indicate that the expansion board is receiving power.



Relay Operation Configuration (Normally Open / Closed Settings)

Jumper configurations for Normally Open and Normally Closed are shown below. The jumpers can be found directly above the relays on the board.

By default, relays are Normally Open.

Normally Open

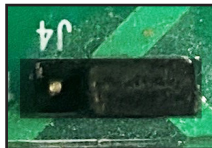

Normally Closed

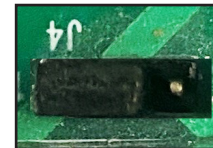

Relay 1 and Relay 2 can be set independently. Their configurations are not dependent upon each other. When wiring the expansion board, ensure that the wiring matches the state of the relay.

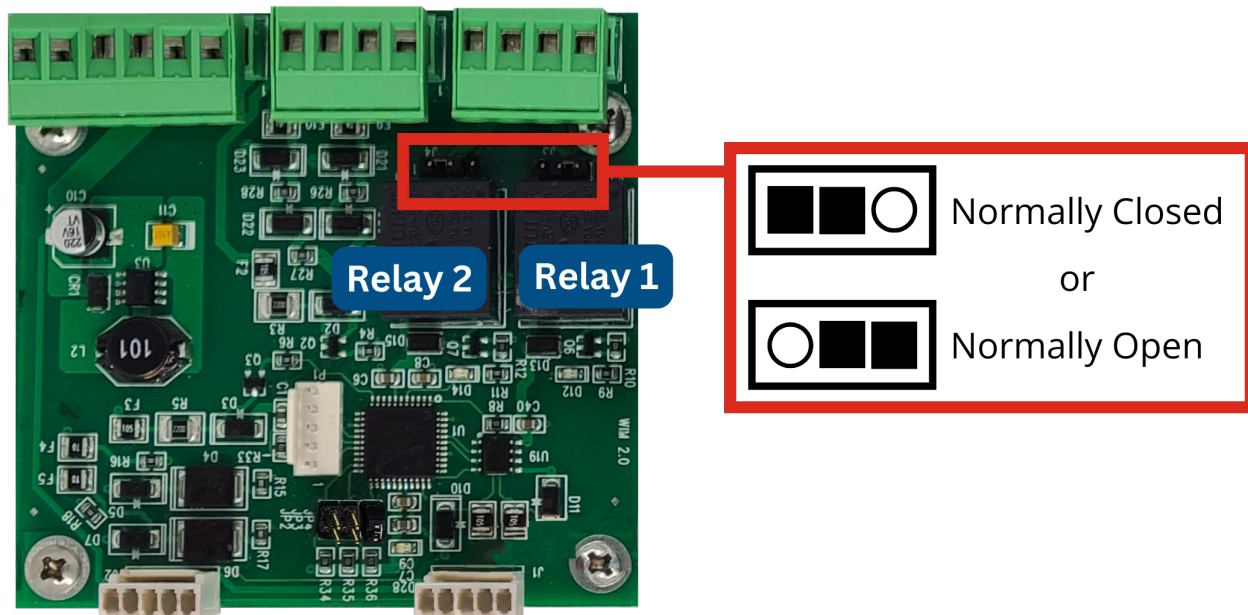

For a 12V Magnetic Lock, set the jumpers as shown above, whether Normally Open or Closed.



Mounting to a Pedestal

If a flush mount is preferred, please contact CellGate for instructions.

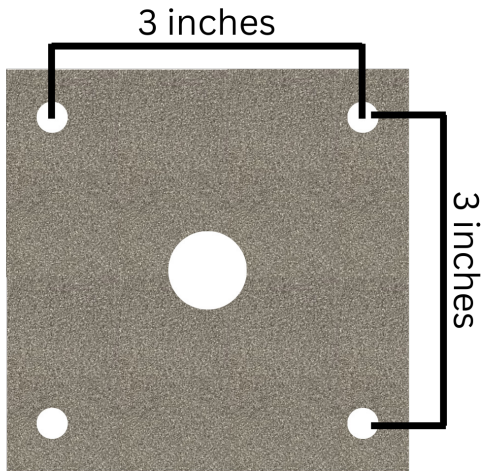

Corner holes are 5mm in diameter.
Gasket is already attached to the back of the device.

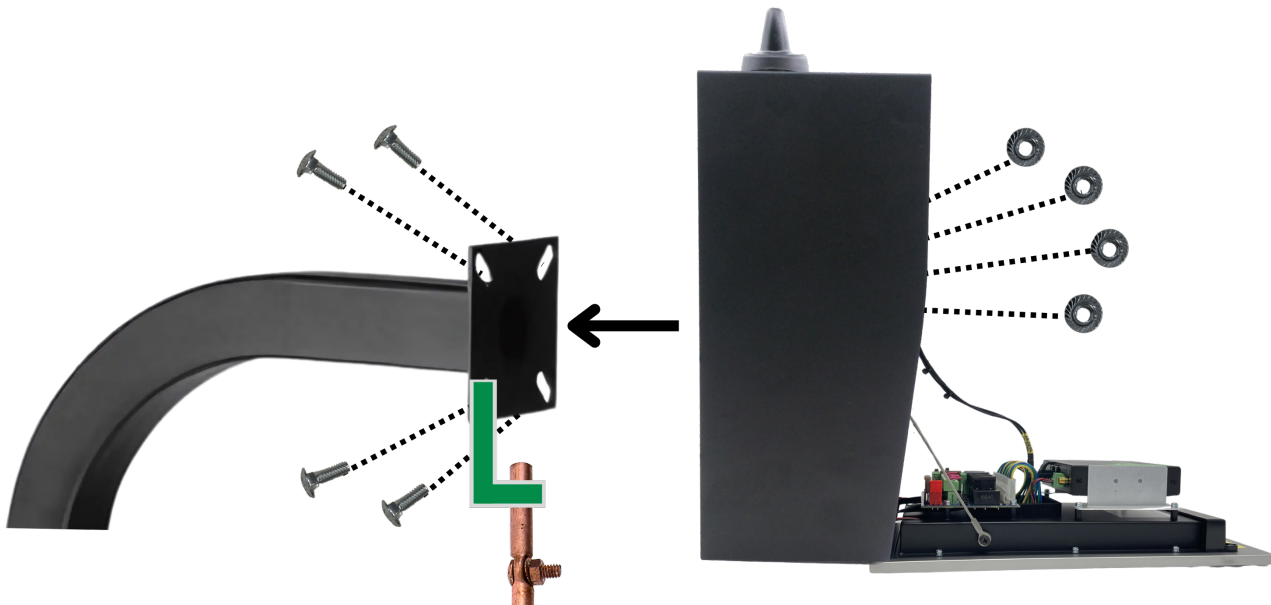

Attach a 14-gauge grounding wire from one of the carriage bolts to a grounding rod.