

# Installation and Owners manual for

## **MAX SUPER ARM 1300**

## **MAX SUPER ARM 2300**

### Actuator Arms

#### **SAFETY SENSORS REQUIRED**

CONFORMS TO UL STD 325  
UL CLASS - I, II, III, IV

CERTIFIED TO CAN/CSA STD  
C22.2 NO. 247

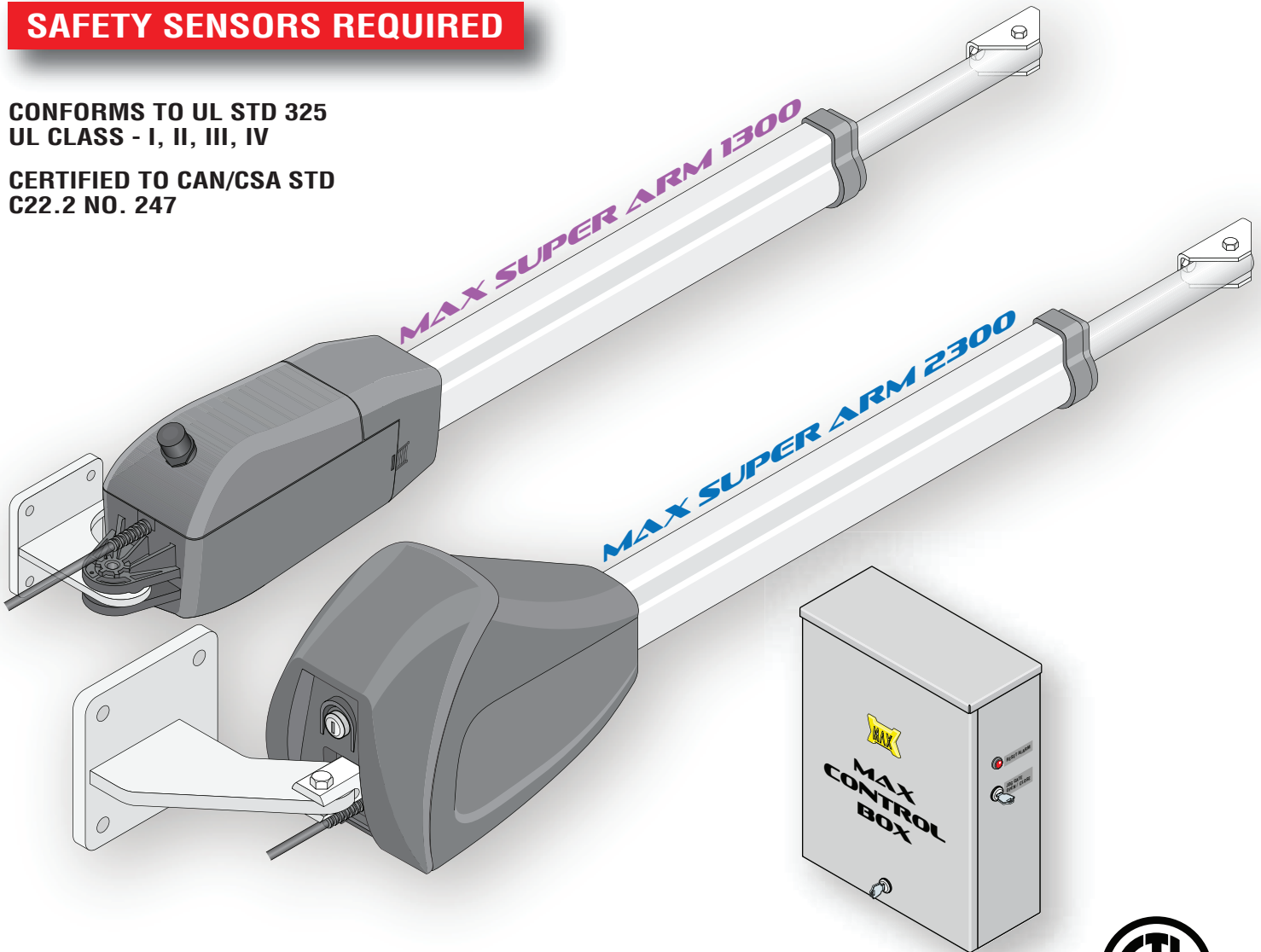

## Residential / Commercial Linear Gate Operators



Intertek  
4009963



# TABLE OF CONTENTS

## SPECIFICATIONS

Control Boxes (AC Powered or Solar)	2
<b>MAX SUPER ARM 1300</b>	3
<b>MAX SUPER ARM 2300</b>	3

## GATE SAFETY AND REQUIREMENTS

Important	4
Gate Construction Information	4
General Requirements	4
UL 325 Compliant Installation Requirements	5-6
Important Safety Information	7
UL 325 Model Classifications	8
Gate Safety Installation	9-10
Intended Use of Swing Gate Operator	11

## STEP-BY-STEP INSTALLATION

<b>1</b> Mount Arm	12-17
<b>1a</b> <b>MAX SUPER ARM 1300</b>	12-14
<b>1b</b> <b>MAX SUPER ARM 2300</b>	15-17
<b>2</b> Mount Control Box	18
<b>3a</b> AC Input Power 115VAC	19
<b>3b</b> AC Input Power 230VAC	20
<b>4</b> Ground Control Box	21
<b>5</b> Wiring Arm(s) to DSP Board	21
<b>6</b> Settings: Gate/ID Plug/Operator	22
<b>7</b> Select Actuator Type & Gate Length	22
<b>8</b> Gate Limit Adjustments	22-26
<b>PULL OPEN 1300 INSTALL</b>	23
<b>PUSH OPEN 1300 INSTALL</b>	24
<b>PULL OPEN 2300 INSTALL</b>	25
<b>PUSH OPEN 2300 INSTALL</b>	26
<b>9</b> Entrapment Protection Locations (List of Sensors)	27
<b>10</b> Entrapment Protection Wiring (Test Photo CLS NC Sensor)	28
<b>11</b> Adjust ERD Reverse Sensor	29
<b>12</b> Loops & Loop Detectors	29
<b>13</b> DSP Controller Board Settings	30
<b>14</b> Wiring Opening Device Options	30
<b>15</b> UL Sensor Learn Mode	31
<b>16</b> DIP-Switch Settings	31
Dual Gate Operators	32

## ADDITIONAL FEATURES

MAX Open / Fire Dept Inputs	33
Gate Tamper	33
Gate Disable	33
Open / Stop / Close Inputs	34
Reset Alarm Button / Jog Gate Open/Close	34
Programming	34
Close to Lock	35
Max Cell Hub	36
Max Wiegand Converter	36
Max Keypad	36

## SOLAR CONTROL BOX INSTALLATION

Solar Installation	37-39
--------------------	-------

## TROUBLESHOOTING

OBD Port Black Box	40
Test Photo Close NC Sensor	40
Gate Cycling Troubleshooting	41
DSP Board Troubleshooting	42-43

## COMMON SENSOR WIRING

Omron E3K-R10K4	44-45
EMX Wel-200 Wireless	46-47
EMX IRB-RET2	48
EMX IRB-RET	49
EMX IRB-MON (Single Gate)	50
EMX IRB-MON Green TX/RX (Single Gate)	51
Miller R-Band Wireless	52
iGaze RE Kit Wireless	53

## DSP CIRCUIT BOARD OVERVIEW

DSP Circuit Board Overview	54
----------------------------	----

## MANUALLY RELEASE GATE

<b>MAX SUPER ARM 1300</b>	55
<b>MAX SUPER ARM 2300</b>	55

© 2021 Maximum Controls LLC.

All rights reserved. No part of this manual may be reproduced in any means: graphics, electronics or mechanical, including photocopying without the expressed written permission of the publisher. Materials components and specifications are subject to change without notice.

# SPECIFICATIONS

## AC POWERED CONTROL BOX

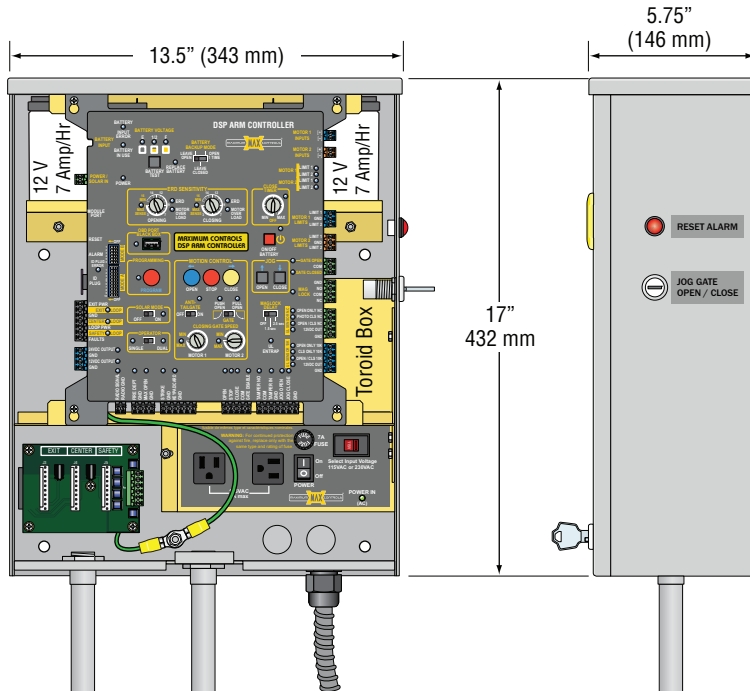

**Class of operation**.....UL 325 Class I, II, III, IV

**Type of gate**.....Vehicular swing gate only

**Input AC power/amps**.....

Switchable: 115VAC / 6 amp, 1 phase

**OR**

230VAC / 2 amp, 1 phase

**Power output**.....24 VDC

**Operating temperature**.....-4°F to 158°F (-20°C to 70°C)

**Cycles per hour AC input power**.....Continuous

**Battery back-up cycles**.....

(7 Amp/Hr batteries fully charged).....Approx 500 cycles

**Entrapment protection**.....

- UL 325 Type A Inherent (ERD sensor)
- Inputs for **NORMALLY CLOSED (N.C.)** or **10K** Type  
UL 325 Type B1 (photo cell) and Type B2 (sensing edge)  
**MONITORED** when used.

## SOLAR POWERED CONTROL BOX

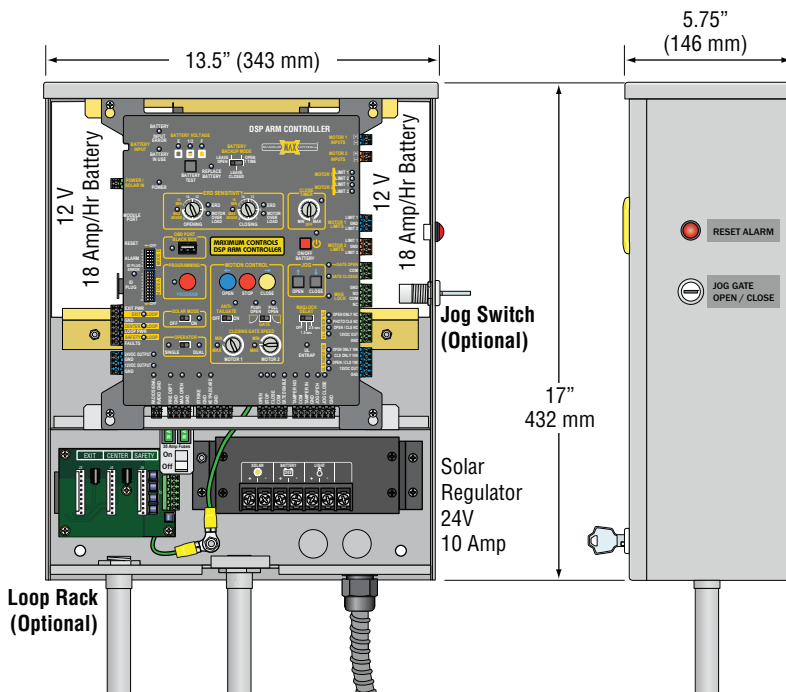

**Class of operation**.....UL 325 Class I, II, III, IV

**Type of gate**.....Vehicular swing gate only

**Solar power**.....

24V Solar Panel

Output: 36V (max) - Open Circuit

**Power output**.....24 VDC

**Operating temperature**.....-4°F to 158°F (-20°C to 70°C)

**Cycles per hour**.....Approx. 60

**Entrapment protection**.....

- UL 325 Type A Inherent (ERD sensor)
- Inputs for **NORMALLY CLOSED (N.C.)** or **10K** Type  
UL 325 Type B1 (photo cell) and Type B2 (sensing edge)  
**MONITORED** when used.

# SPECIFICATIONS

## MAX SUPER ARM 1300

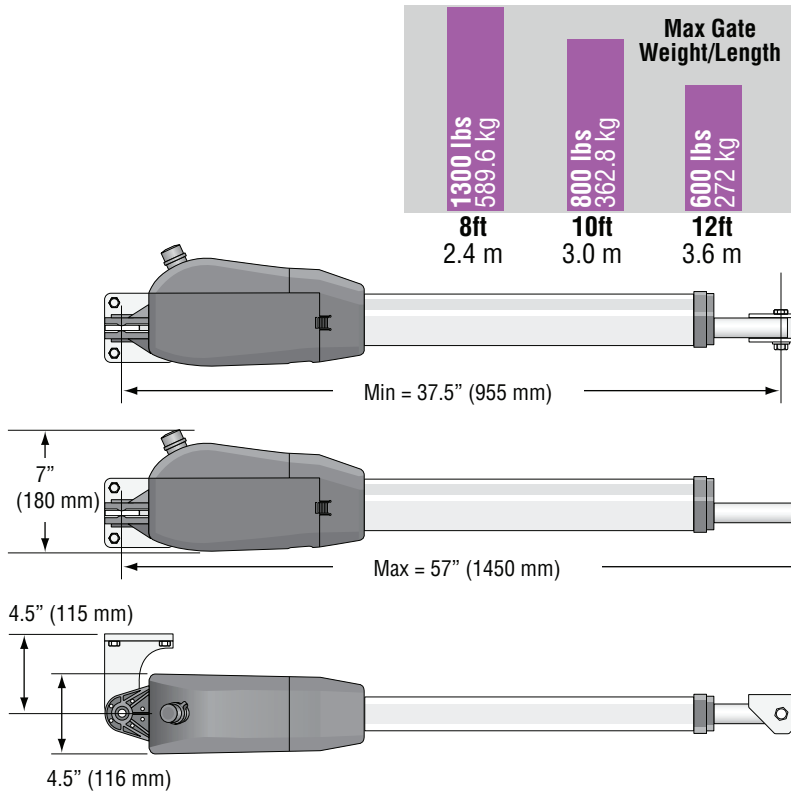

Power supply.....24 VDC  
 Max speed..... .7 in/sec (18 mm/sec)  
 Max stroke length.....19.4 in (495 mm)  
 Max traction and pressure force per leaf.....2500 N  
 Rated torque per leaf.....830 N  
 Max power consumption per gate.....260 W  
 Max current consumption per gate.....1.5 A  
 Power consumption per gate.....96 W  
 Current consumption per gate.....0.55 A  
 Max gate weight per gate.....1543 lbs (700 Kg)  
 Max gate length.....157.5 inches (4 m)  
 Operating Temperatures:  
 -22°F to ~+158°F (-30°C ~+70°C)

## MAX SUPER ARM 2300

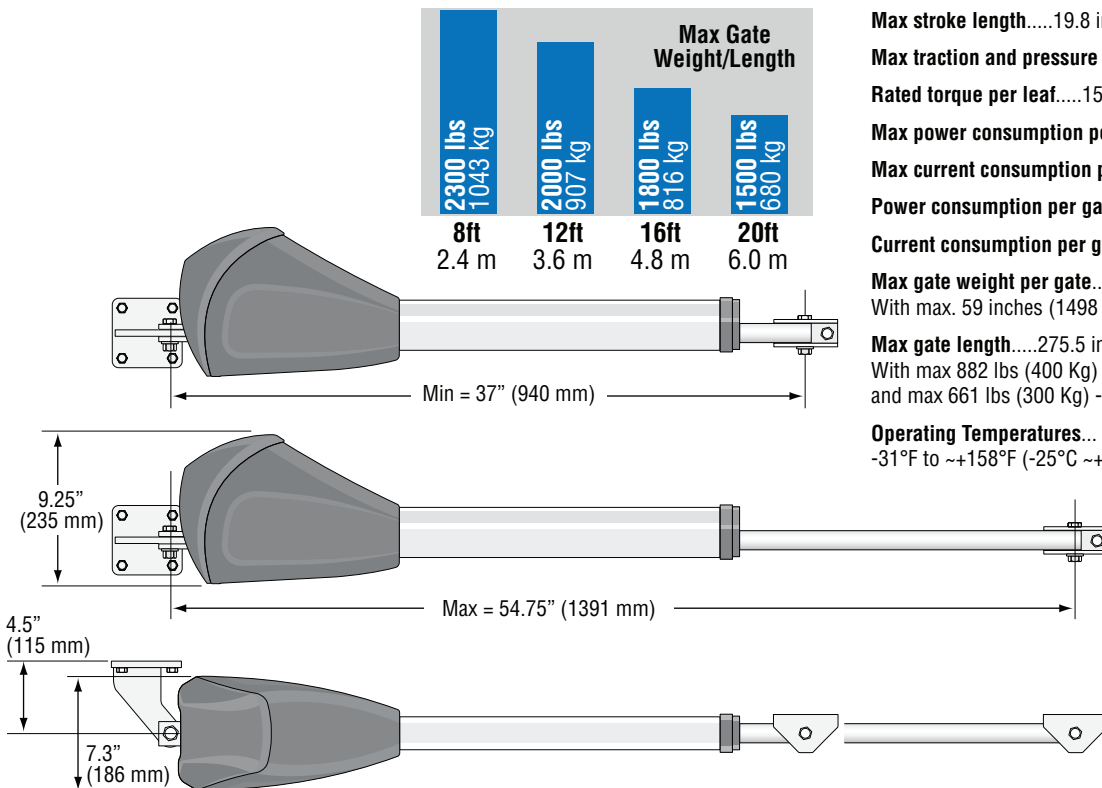

Power supply.....24 VDC  
 Max speed..... .7 in/sec (17.7 mm/sec)  
 Max stroke length.....19.8 in (503 mm)  
 Max traction and pressure force per leaf.....4500 N  
 Rated torque per leaf.....1500 N  
 Max power consumption per gate.....245 W  
 Max current consumption per gate.....1.2 A  
 Power consumption per gate.....115 W  
 Current consumption per gate.....0.6 A  
 Max gate weight per gate..... 2425 lbs (1100 Kg)  
 With max. 59 inches (1498 mm) gate width, single gate.  
 Max gate length.....275.5 inches (7 m)  
 With max 882 lbs (400 Kg) - single gate  
 and max 661 lbs (300 Kg) - per gate, dual gates.  
 Operating Temperatures...  
 -31°F to ~+158°F (-25°C ~+70°C)

MAX SUPER ARM 1300

MAX SUPER ARM 2300

# IMPORTANT

**BEFORE** attempting to install, operate or maintain the operator, you must read and fully understand this manual and follow **ALL** safety instructions. **DO NOT** attempt repair or service of your gate operator unless you are an Authorized Service Technician.

## GATE CONSTRUCTION INFORMATION

Vehicular gates should be installed in accordance with ASTM F2200: Standard Specification for Automated Vehicular Gate Construction. For a copy, contact ASTM directly at 610-832-9585 or [www.astm.org](http://www.astm.org).

## GENERAL REQUIREMENTS

Gates shall be constructed in accordance with the provisions given for the appropriate gate type listed, refer to ASTM F2200 for additional gate types.

Gates shall be designed, constructed and installed to not fall over more than 45 degrees from the vertical plane, when a gate is detached from the supporting hardware.

Gates shall have smooth bottom edges, with vertical bottom edged protrusions not exceeding 0.50 inches (12.7 mm) when other than the exceptions listed in ASTM F2200.

The minimum height for barbed tape shall not be less than 8 feet (2.44 m) above grade and for barbed wire shall not be less than 6 feet (1.83 m) above grade. An existing gate latch shall be disabled when a manually operated gate is retrofitted with a powered gate operator.

A gate latch shall not be installed on an automatically operated gate.

Protrusions shall not be permitted on any gate, refer to ASTM F2200 for Exceptions.

Gates shall be designed, constructed and installed such that their movement shall not be initiated by gravity when an automatic operator is disconnected, in accordance with the following.

Vehicular horizontal slide gate. Shall not result in continuous, unimpeded movement in either lineal direction of its travel.

Vehicular horizontal swing gate. Shall not result in continuous, unimpeded movement in either direction along the arc of its path of travel.

For pedestrian access in the vicinity of an automated vehicular gate, a separate pedestrian gate shall be provided. The pedestrian gate shall be installed in a location such that a pedestrian shall not come in contact with a moving vehicular access gate. A pedestrian gate shall not be incorporated into an automated vehicular gate panel.

Any existing automated gate, when the operator requires replacement, shall be upgraded to conform to the provisions of this specification in effect at that time.

### **Vehicular horizontal slide gate:**

All weight bearing exposed rollers 8 feet (2.44 m), or less, above grade shall be guarded or covered.

All openings shall be designed, guarded, or screened from the bottom of the gate to the top of the gate or a minimum of 72 in. (1.83 m) above grade, whichever is less, to prevent a 2 1/4 in. (57 mm) diameter sphere from passing through the openings anywhere in the gate, and in that portion of the adjacent fence that the gate covers in the open position. The gate panel shall include the entire section of the moving gate, including any back frame or counterbalance portion of the gate.

A gap, measured in the horizontal plane parallel to the roadway, between a fixed stationary object nearest the roadway, (such as a gate support post) and the gate frame when the gate is in either the fully open position or the fully closed position, shall not exceed 2 1/4 inches (57 mm), refer to ASTM F2200 for Exception.

Positive stops shall be required to limit travel to the designed fully open and fully closed positions. These stops shall be installed at either the top of the gate, or at the bottom of the gate where such stops shall horizontally or vertically project no more than is required to perform their intended function.

All gates shall be designed with sufficient lateral stability to assure that the gate will enter a receiver guide, refer to ASTM F2200 for panel types.

### **The following provisions shall apply to Class IV vehicular horizontal slide gates:**

All weight bearing exposed rollers 8 feet (2.44 m), or less, above grade shall be guarded or covered.

Positive stops shall be required to limit travel to the designed fully open and fully closed positions. These stops shall be installed at either the top of the gate, or at the bottom of the gate where such stops shall horizontally or vertically project no more than is required to perform their intended function.

### **Vehicular horizontal swing gate:**

Gates shall be designed, constructed and installed so as not to create an entrapment area between the gate and the supporting structure or other fixed object when the gate moves toward the fully open position.

The width of an object (such as a wall, pillar or column) covered by a swing gate when in the open position shall not exceed 4 inches (102 mm), measured from the center line of the pivot point of the gate, refer to ASTM F2200 for exception.

The distance between a fixed object such as a wall, pillar or column, and a swing gate when in the open position shall not be less than 16 inches (406 mm), refer to ASTM F2200 for exception.

**ONLY Class IV vehicular horizontal swing gates** shall be designed, constructed and installed in accordance with security related parameters specific to the application.

# UL 325 COMPLIANT INSTALLATION REQUIREMENTS

a) Install the gate operator only when:

a) N'installez l'ouvre-barrière que si :

1) The operator is appropriate for the construction of the gate and the usage Class of the gate,

1) l'ouvre-barrière est approprié pour la structure et la classe d'utilisation de la barrière;

2) All openings of a horizontal slide gate are guarded or screened from the bottom of the gate to a minimum of 1.83 m (6 ft) above the ground to prevent a 57.2 mm (2-1/4 inch) diameter sphere from passing through the openings anywhere in the gate, and in that portion of the adjacent fence that the gate covers in the open position,

2) toutes les ouvertures de la barrière coulissante sont protégées ou grillagées du bas de la porte jusqu'à un minimum de 1,83 m (6 pi) du sol si bien qu'une sphère de 57,2 mm (2 1/4 po) de diamètre ne peut passer par une ouverture au niveau de la barrière et de la portion de la clôture adjacente que la barrière couvre en position ouverte;

3) All exposed pinch points are eliminated or guarded, and

3) tous les points de pincement sont éliminés ou protégés;

4) Guarding is supplied for exposed rollers.

4) des protections sont fournies pour les galets exposés.

b) The operator is intended for installation only on gates used for vehicles. Pedestrians must be supplied with a separate access opening. The pedestrian access opening shall be designed to promote pedestrian usage. Locate the gate such that persons will not come in contact with the vehicular gate during the entire path of travel of the vehicular gate.

b) L'ouvre-barrière est destiné à n'être installé que sur des barrières utilisées pour les véhicules. Il faut fournir une autre voie d'accès aux piétons. La voie d'accès pour les piétons doit être conçue pour favoriser le passage des piétons. Placez la barrière de sorte que personne ne puisse entrer en contact avec la barrière pour les véhicules sur l'ensemble de sa trajectoire.

c) The gate must be installed in a location so that enough clearance is supplied between the gate and adjacent structures when opening and closing to reduce the risk of entrapment. Swinging gates shall not open into public access areas.

c) Pour réduire les risques de coincement lors de l'ouverture et de la fermeture, la barrière doit être installée dans un endroit où la barrière et les structures avoisinantes sont suffisamment éloignées l'une de l'autre. Les barrières battantes ne doivent pas ouvrir dans une zone d'accès public.

d) The gate must be properly installed and work freely in both directions prior to the installation of the gate operator. Do not over-tighten the operator clutch or pressure relief valve to compensate for a damaged gate.

d) La barrière doit être bien installée et fonctionner librement dans les deux directions avant d'entreprendre l'installation de l'ouvre-barrière. Ne serrez pas trop l'embrayage ou la soupape de surpression de l'ouvre-barrière pour compenser une barrière endommagée.

e) For gate operators utilizing Type D protection:

e) Pour les ouvre-barrières qui utilisent des protections de type D :

1) The gate operator controls must be placed so that the user has full view of the gate area when the gate is moving,

1) les commandes de l'ouvre-barrière doivent être placées de sorte que l'utilisateur voit l'ensemble de la zone de la barrière lorsque cette dernière est en mouvement;

2) The placard as required by 62.1.6 shall be placed adjacent to the controls,

2) l'étiquette requise selon la clause 62.1.6 doit être placée à côté des commandes;

3) An automatic closing device (such as a timer, loop sensor, or similar device) shall not be employed, and

3) un dispositif de fermeture automatique (comme une minuterie, une boucle de détection ou un dispositif similaire) ne doit pas être utilisé;

4) No other activation device shall be connected.

4) aucun autre appareil d'activation ne doit être connecté.

f) Controls intended for user activation must be located at least 1.83 m (6 ft) away from any moving part of the gate and where the user is prevented from reaching over, under, around or through the gate to operate the controls.

f) Les commandes destinées à l'activation par l'utilisateur doivent être situées à au moins 1,83 m (6 pi) des pièces mobiles de la barrière et à un endroit où l'utilisateur ne peut pas atteindre les commandes par le dessus, par le dessous, par les côtés et au travers de la barrière.

Exception: Emergency access controls only accessible by authorized personnel (e.g. fire, police, EMS) may be placed at any location in the line-of-sight of the gate.

Exception : Les commandes d'accès d'urgence accessibles au personnel autorisé seulement (p. ex. pompier, policier, SMU) peuvent être placées à tout endroit dans le champ de visibilité de la barrière.

# UL 325 COMPLIANT INSTALLATION REQUIREMENTS CONTINUED

g) The Stop and/or Reset button must be located in the line-of-sight of the gate. Activation of the reset control shall not cause the operator to start.

g) Le bouton d'arrêt, le bouton de réenclenchement ou ces deux boutons doivent être situés dans le champ de visibilité de la barrière. L'activation des commandes de réenclenchement ne doit pas mettre en marche l'ouvrebarrière.

h) A minimum of two (2) WARNING SIGNS shall be installed, in the area of the gate. Each placard is to be visible by persons located on the side of the gate on which the placard is installed. Also see 62.1.1.

h) Au moins deux panneaux de mise en garde doivent être installés dans la zone de la barrière. Chaque étiquette doit être visible des personnes situées de chaque côté de la barrière sur laquelle l'étiquette est installée. Voir aussi la clause 62.1.1.

i) For gate operators utilizing a non-contact sensor in accordance with 32.1.1:

i) Pour les ouvre-barrières qui fonctionnent avec des capteurs sans contact conformément à la clause 32.1.1 :

1) See instructions on the placement of non-contact sensors for each Type of application,

1) Voir les instructions sur le positionnement des capteurs sans contact pour chaque type d'utilisation.

2) Care shall be exercised to reduce the risk of nuisance tripping, such as when a vehicle, trips the sensor while the gate is still moving, and

2) Des précautions doivent être prises pour réduire les risques de déclenchement inutile, comme lorsqu'un véhicule déclenche le capteur alors que la barrière est encore en mouvement.

3) One or more non-contact sensors shall be located where the risk of entrapment or obstruction exists, such as the perimeter reachable by a moving gate or barrier.

3) Un capteur sans contact ou plus doit être situé où il existe un risque de coincement ou d'obstruction, comme dans l'espace que peut occuper la barrière lorsqu'elle est en mouvement.

j) For a gate operator utilizing a contact sensor in accordance with 32.1.1:

j) Pour les ouvre-barrières qui fonctionnent avec des capteurs de contact conformément à la clause 32.1.1 :

1) One or more contact sensors shall be located where the risk of entrapment or obstruction exists, such as at the leading edge, trailing edge, and postmounted both inside and outside of a vehicular horizontal slide gate.

1) Au moins un capteur de contact doit être situé où il existe un risque de coincement ou d'obstruction, comme sur le bord d'ouverture, sur le bord de fermeture et sur les poteaux montés sur l'intérieur ou l'extérieur d'une barrière coulissante pour véhicules.

2) One or more contact sensors shall be located at the bottom edge of a vehicular vertical lift gate.

2) Au moins un capteur de contact doit être situé sur le bord inférieur d'une barrière levante pour véhicules.

3) One or more contact sensors shall be located at the pinch point of a vehicular vertical pivot gate.

3) Au moins un capteur de contact doit être situé au point de pincement d'une barrière à pivot vertical pour véhicules.

4) A hardwired contact sensor shall be located and its wiring arranged so that the communication between the sensor and the gate operator is not subjected to mechanical damage.

4) Un capteur de contact doit être installé et câblé de sorte à éviter que la communication entre le capteur et l'ouvrebarrière soit gênée par des dommages mécaniques.

5) A wireless device such as one that transmits radio frequency (RF) signals to the gate operator for entrapment protection functions shall be located where the transmission of the signals are not obstructed or impeded by building structures, natural landscaping or similar obstruction. A wireless device shall function under the intended end-use conditions.

5) Un dispositif sans fil, comme un appareil qui transmet des signaux de radiofréquence (RF) à l'ouvre-barrière pour prévenir le coincement, doit être situé à un endroit où la transmission des signaux ne sera pas obstruée ou gênée par des structures, des arbres ou d'autres obstacles similaires. Un dispositif sans fil doit fonctionner selon les conditions d'utilisation finale prévues.

6) One or more contact sensors shall be located on the inside and outside leading edge of a swing gate. Additionally, if the bottom edge of a swing gate is greater than 152 mm (6 inches) but less than 406 mm (16 inches) above the ground at any point in its arc of travel, one or more contact sensors shall be located on the bottom edge.

6) Au moins un capteur de contact doit être situé sur les bords d'ouverture intérieur et extérieur d'une barrière battante. De plus, si le dessous d'une barrière battante est situé à plus de 152 mm (6 po) mais à moins de 406 mm (16 po) du sol à l'un des points de sa trajectoire, au moins un capteur de contact doit être situé sur le bord inférieur.

7) One or more contact sensors shall be located at the bottom edge of a vertical barrier (arm).

7) Au moins un capteur de contact doit être situé sur le bord inférieur d'une barrière verticale (bras).

# IMPORTANT SAFETY INFORMATION

IMPORTANT SAFETY INSTRUCTIONS WARNING – To reduce the risk of injury or death:  
INSTRUCTIONS DE SÉCURITÉ IMPORTANTES AVERTISSEMENT – Pour réduire les risques de blessures et de mort :

1. READ AND FOLLOW ALL INSTRUCTIONS.  
1. LISEZ ET SUIVEZ TOUTES LES INSTRUCTIONS.
2. Never let children operate or play with gate controls. Keep the remote control away from children.  
2. Ne laissez jamais les enfants manoeuvrer les commandes de la barrière ou jouer avec celles-ci. Laissez la télécommande hors de la portée des enfants.
3. Always keep people and objects away from the gate. NO ONE SHOULD CROSS THE PATH OF THE MOVING GATE.  
3. Tenez toujours à l'écart de la barrière toute personne ou tout objet avoisinant. IL NE FAUT JAMAIS PASSER DANS LA TRAJECTOIRE D'UNE BARRIÈRE EN MOUVEMENT.
4. Test the gate operator monthly. The gate MUST reverse on contact with a rigid object or stop when an object activates the non-contact sensors. After adjusting the force or the limit of travel, retest the gate operator. Failure to adjust and retest the gate operator properly can increase the risk of injury or death.  
4. Vérifiez le fonctionnement de l'ouvre-barrière une fois par mois. Le sens de la course DOIT s'inverser lorsque la barrière entre en contact avec un objet dur ou la barrière DOIT s'arrêter lorsqu'un objet active les capteurs sans contact. Vérifiez à nouveau l'ouvre-barrière après tout réglage de la force de déclenchement ou du seuil de fin de course. Un réglage incorrect de l'ouvre-barrière ou l'omission de vérifier à nouveau le fonctionnement de l'ouvre-barrière peut causer des blessures, voire la mort.
5. Use the emergency release only when the gate is not moving.  
5. Ne déclenchez le dispositif de désaccouplement d'urgence que lorsque la barrière ne bouge pas.
6. KEEP GATES PROPERLY MAINTAINED. Read the user's manual. Have a qualified service person make repairs to gate hardware.  
6. ASSUREZ-VOUS QUE LA BARRIÈRE EST CORRECTEMENT ENTRETENUE. Lisez le manuel de l'utilisateur. Confiez la réparation du matériel de la barrière à un technicien qualifié.
7. The entrance is for vehicles only. Pedestrians must use separate entrance.  
7. La voie d'accès est réservée aux véhicules seulement. Les piétons doivent utiliser une voie d'accès différente.
8. SAVE THESE INSTRUCTIONS.  
8. CONSERVEZ CES INSTRUCTIONS.

# UL 325 MODEL CLASSIFICATIONS



**CLASS I**

**Residential Vehicular Gate Operator** - A vehicular gate operator (opener or system) intended for use in a home of one to four single family dwellings, or a garage or parking area associated therewith.

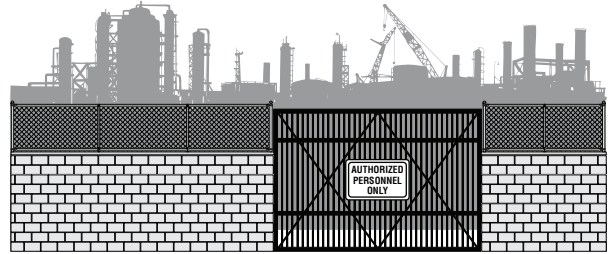

**CLASS III**

**Industrial/Limited Access Vehicular Gate Operator** - A vehicular gate operator (opener or system) intended for uses in an industrial location, loading dock area or other location not intended to service the general public.

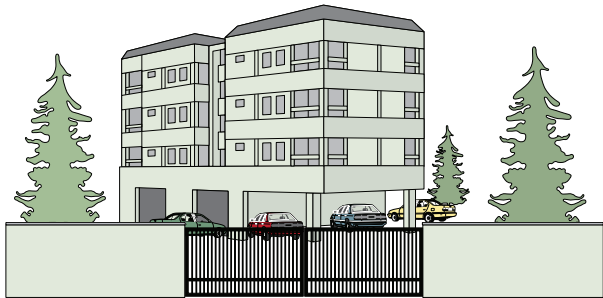

**CLASS II**

**Commercial/General Access Vehicular Gate Operator** - A vehicular gate operator (opener or system) intended for use in a commercial location or building such as a multi-family housing unit (five or more single family units) hotel, garages, retail store or other building servicing the general public.

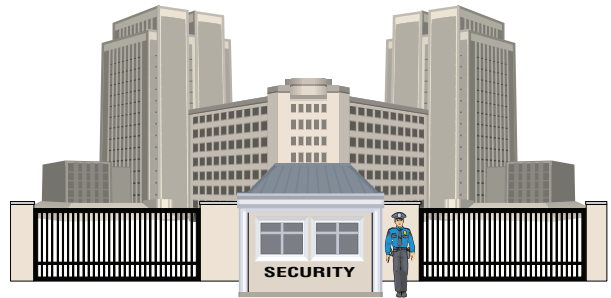

**CLASS IV**

**Restricted Access Vehicular Gate Operator** - A vehicular gate operator (opener or system) intended for use in a guarded industrial location or buildings such as airport security area or other restricted access locations not servicing the general public, in which unauthorized access is prevented via supervision by security personnel.

## UL 325 REQUIRED ENTRAPMENT PROTECTION

This vehicular gate operator must be installed with at least two independent entrapment protection means as specified in the table and definitions below.

The same type of device shall not be used for both entrapment protection means. Use of a single device to cover both the opening and closing directions is in accordance with the requirement, however, a single device is not required to cover both directions. This operator has been provided with type A entrapment protection. The installer is required to install additional entrapment protection devices in each entrapment area.

Gate Type	Class I & II	Class III & IV
Swing Gate	A, B1*, B2*, C, D	A, B1*, B2*, C, D, E
Slide Gate	A, B1*, B2*, D	A, B1*, B2*, D, E

**A** - Inherent entrapment protection system.

**B1** - Provision for connection of a non-contact sensor (photoelectric sensor or the equivalent).

**B2** - Provision for connection of a contact sensor (edge device or the equivalent).

\* B1 and B2 means of entrapment protection must be MONITORED.

**C** - Inherent adjustable clutch or pressure relief device.

**D** - Provision for connection of an actuating device requiring continuous pressure to maintain opening or closing motion of the gate.

**E** - An audio alarm.

# GATE SAFETY INSTALLATION

Weld a horizontal bar across entire gate on any installation for strength. **DO NOT** weld the crossbar on just a few pickets, or they could bend. Make sure that the operator is mounted **level** or it will not function properly. Arm should be mounted at least 12 inches above the ground. Make sure there is slack in the operator cable. **DO NOT** over-bend the operator cable. Doing this will cause the wires to eventually break. **DO NOT** install on **ANY** pedestrian passageways, doorways, or gates.

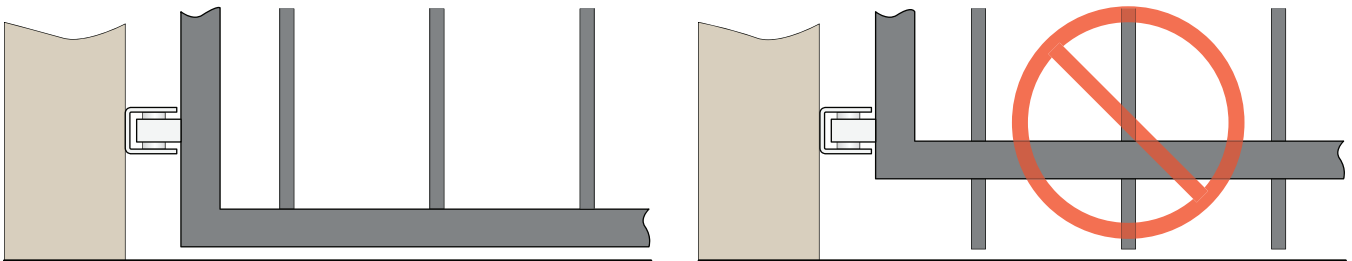
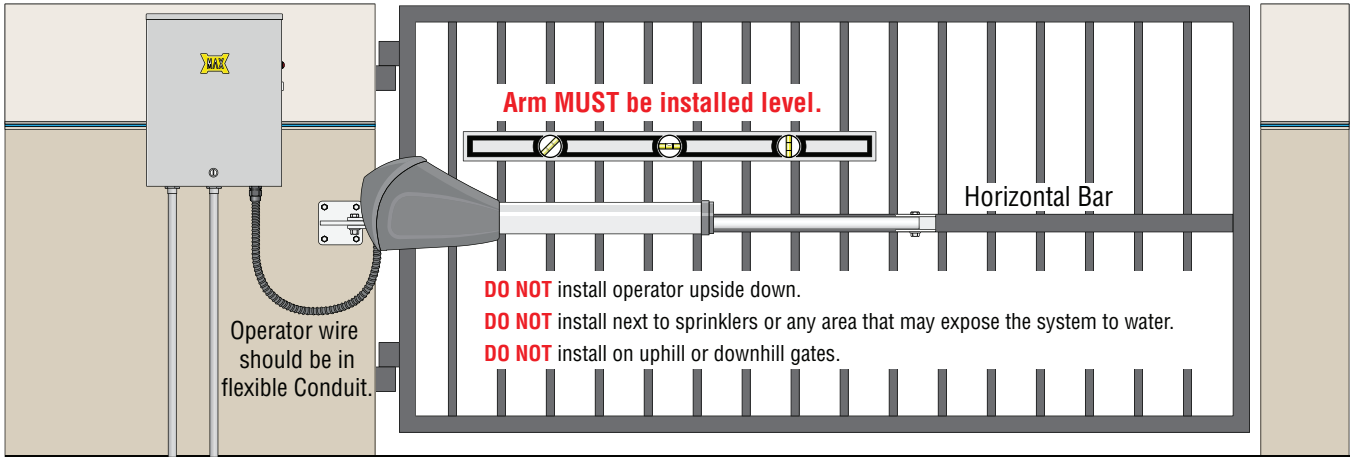

Gate should have a **smooth** bottom edge, with vertical bottom edged protrusions not exceeding 0.50 inches.

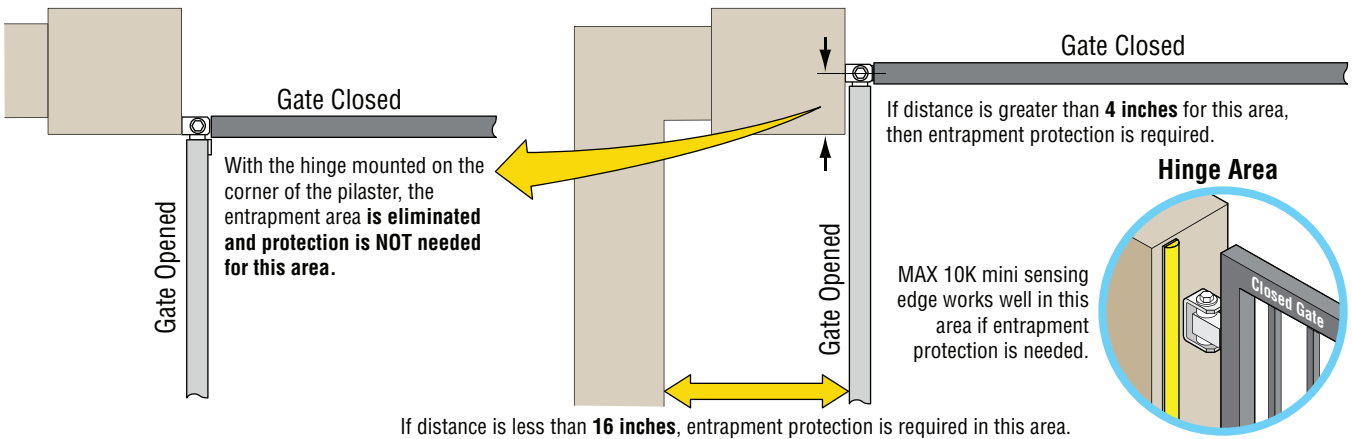
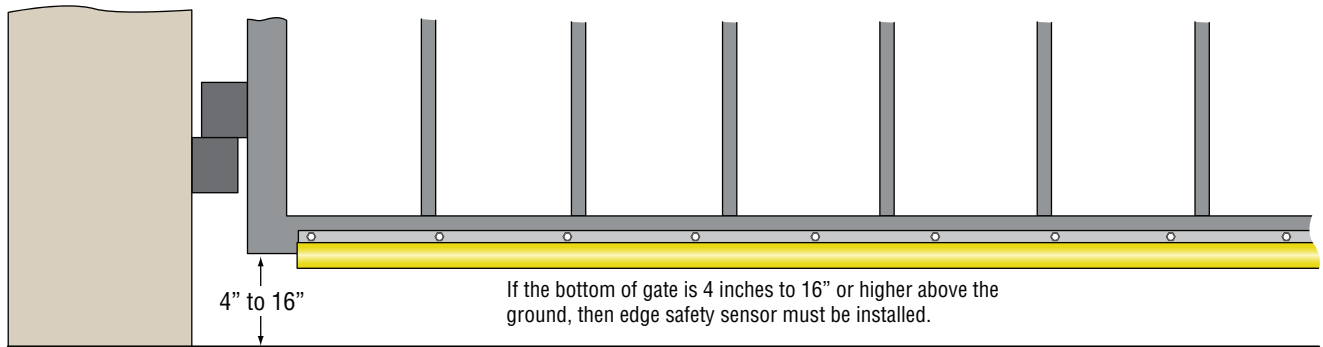

# GATE SAFETY INSTALLATION

**DO NOT** install on uphill or downhill gates.

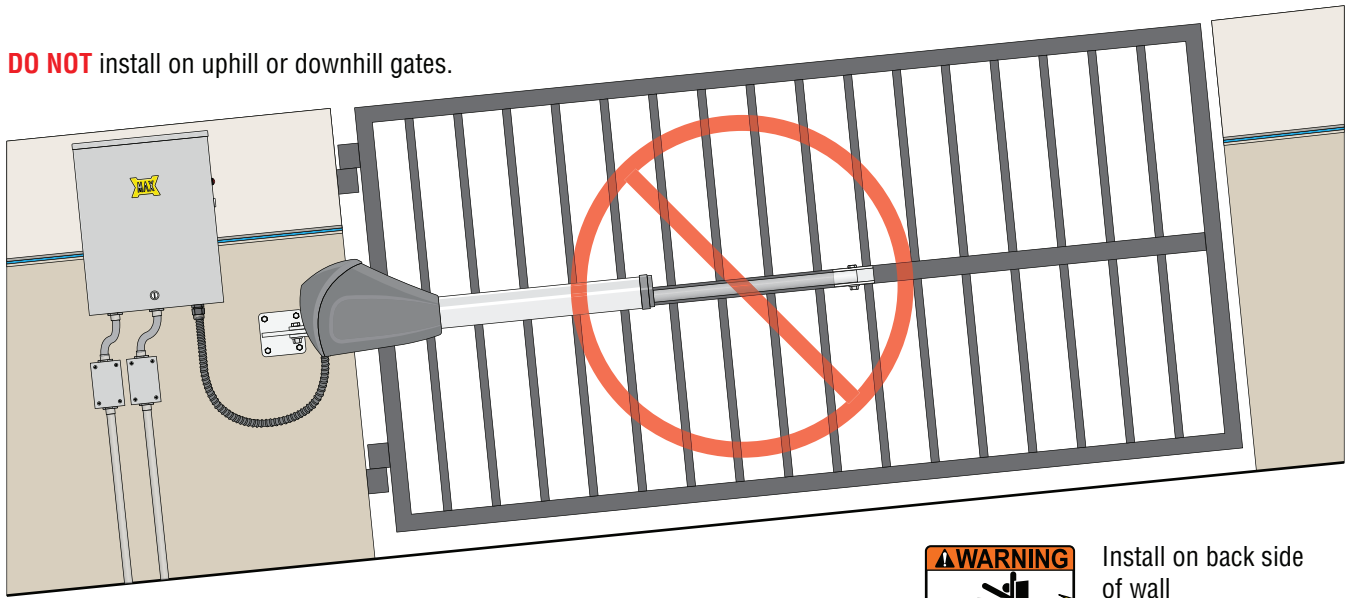

Install on back side of wall



**DO NOT** install an opening device accessible through the gate. It **MUST** be mounted a minimum of 6 feet away from all moving parts of the gate and in sight of the gate. Install it high enough to keep out of reach of small children.



# INTENDED USE OF SWING GATE OPERATOR

The operator is intended for use on a **VEHICULAR** slide gate ONLY. It is intended to be used **WITH** appropriate entrapment protection safety devices and in-ground vehicle loop detection system. This operator has an inherent entrapment protection system and requires additional external **monitored** entrapment protection devices (Non-contact Photo sensors or contact sensing edges) for each entrapment area prior to gate operation. Pedestrians **MUST** use a separate entrance.

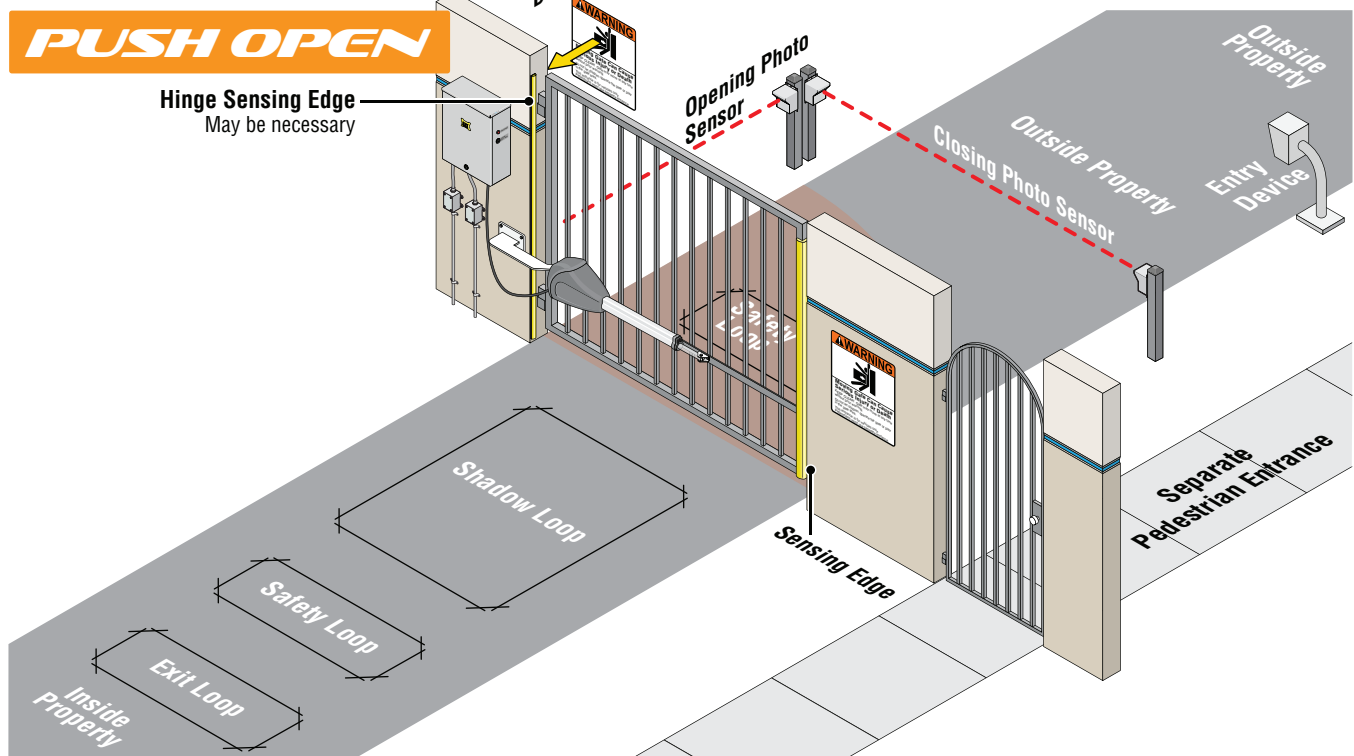
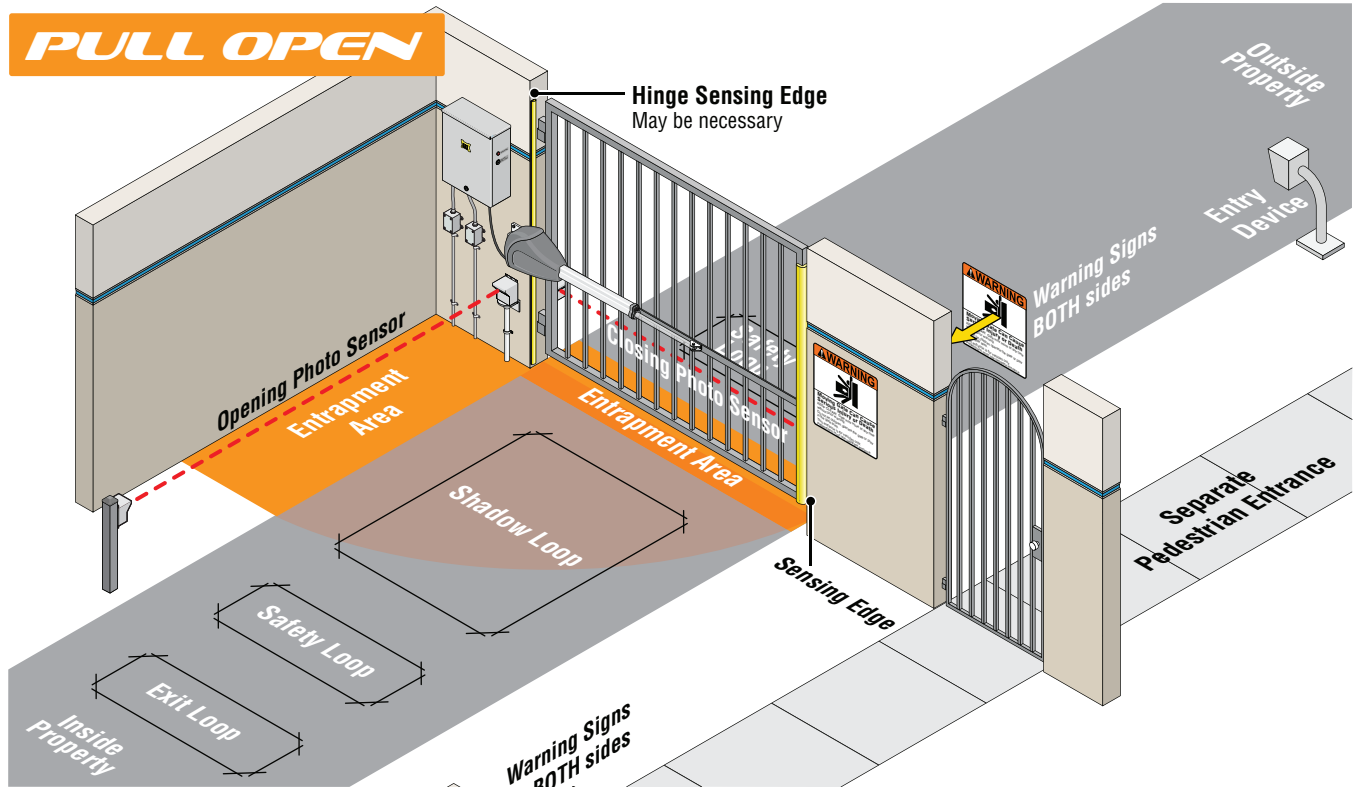

# STEP-BY-STEP INSTALLATION

Read and understand this ENTIRE manual BEFORE installation. Check with the local building department prior to installing this gate operator to comply with local building code requirements. The gate must be installed in a location so that enough clearance is supplied between the gate and adjacent structures when opening and closing to reduce the risk of entrapment. Swinging gates should not open into public access areas.

Start by selecting your model gate operator for Step 1.

**1a** MAX SUPER ARM 1300 Page 12-14

**1b** MAX SUPER ARM 2300 Page 15-17

## 1a MOUNT SUPER ARM 1300

### RELEASE 1300 DRIVE ROD

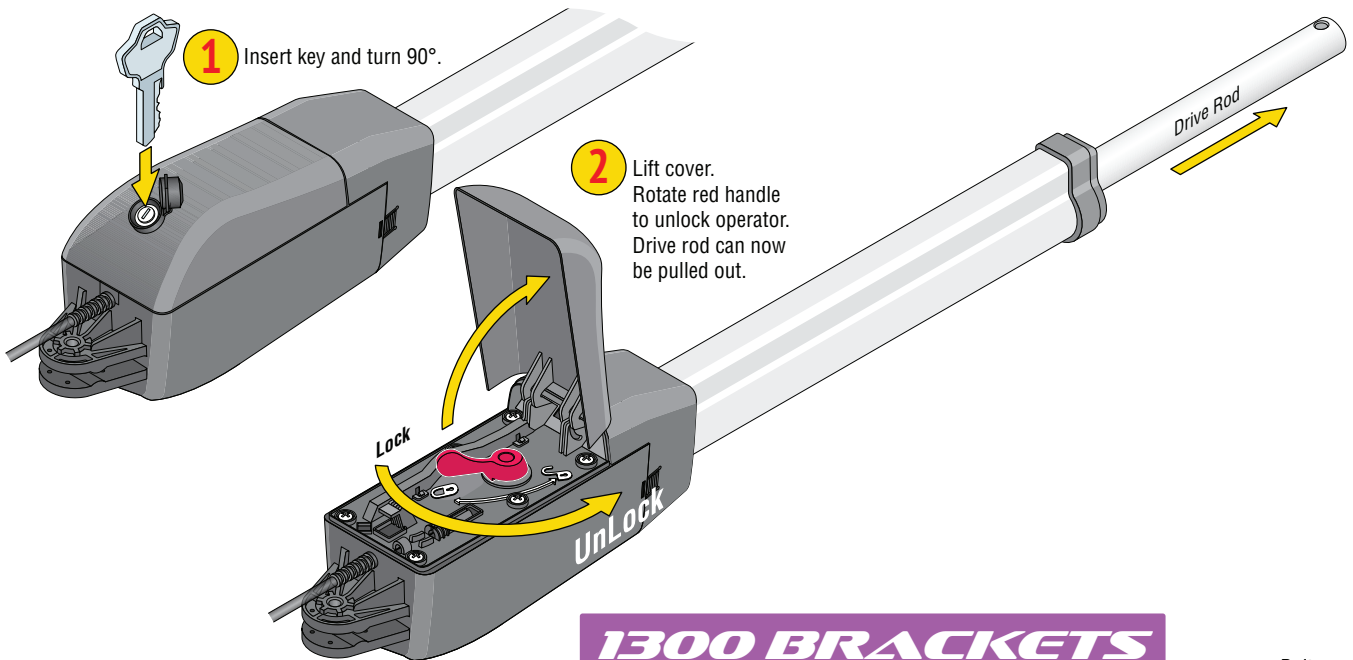

### 1300 BRACKETS

#### PULL Open Rear Bracket

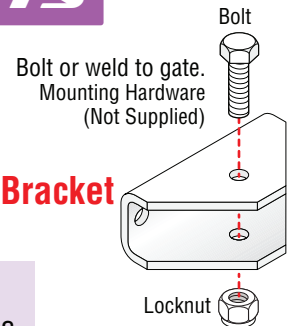
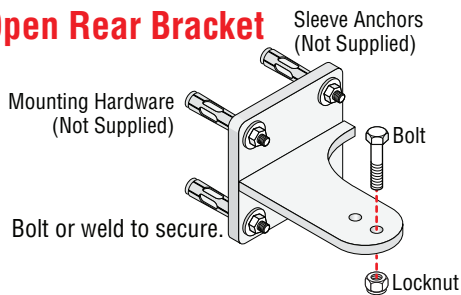

See page 14 for bracket positions and dimensions.

#### PUSH Open Rear Bracket

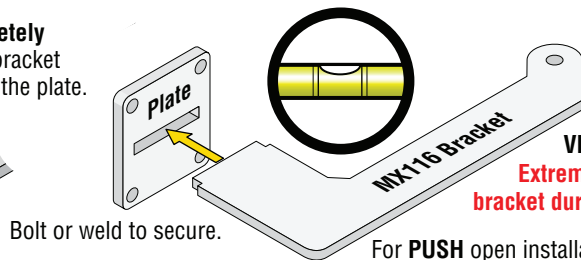
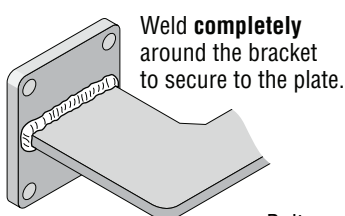

The bracket **MUST** be level and **VERY** secure to the plate and wall. Extreme force will be exerted on this bracket during gate cycling.

For **PUSH** open installation, please order MX116.

# MOUNTING 1300 ARM INFORMATION

Gate must be in good working condition before the actuator arm can be installed. Determine what direction the actuator arm will open the gate: "PULL OPEN" or "PUSH OPEN" Installation (See next page). See the "GATE SAFETY and REQUIREMENTS" in front of this manual (pages 4-11) for mounting requirements and limitations.

## Drive Rod Extension

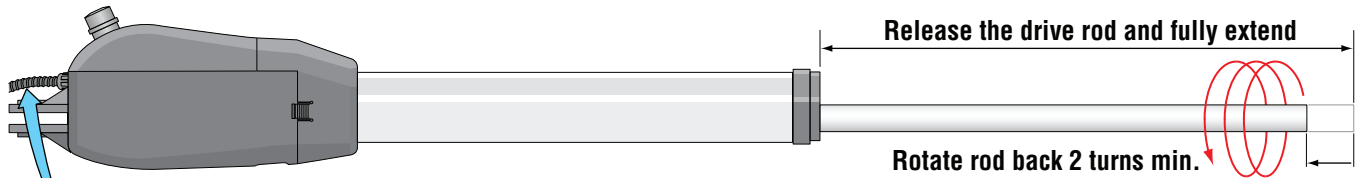

**IMPORTANT:** Drive rod **MUST NOT** be **FULLY** extended when installed. This will damage the arm. Rotate fully extended rod back **at least** two full turns **BEFORE** installing the arm.

## Flex Conduit

The operator wire needs to be in a flexible conduit (not provided).

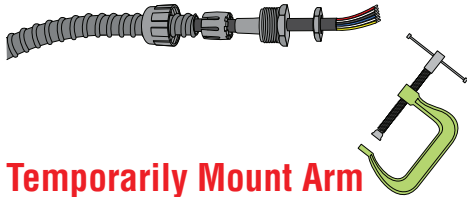

## Temporarily Mount Arm

Temporarily mount arm in desired position determined by next page's dimensions. Manually swing gate to the **OPEN** and **CLOSE** positions. When satisfied with gate positions, permanently mount brackets making sure that arm is **LEVEL**.

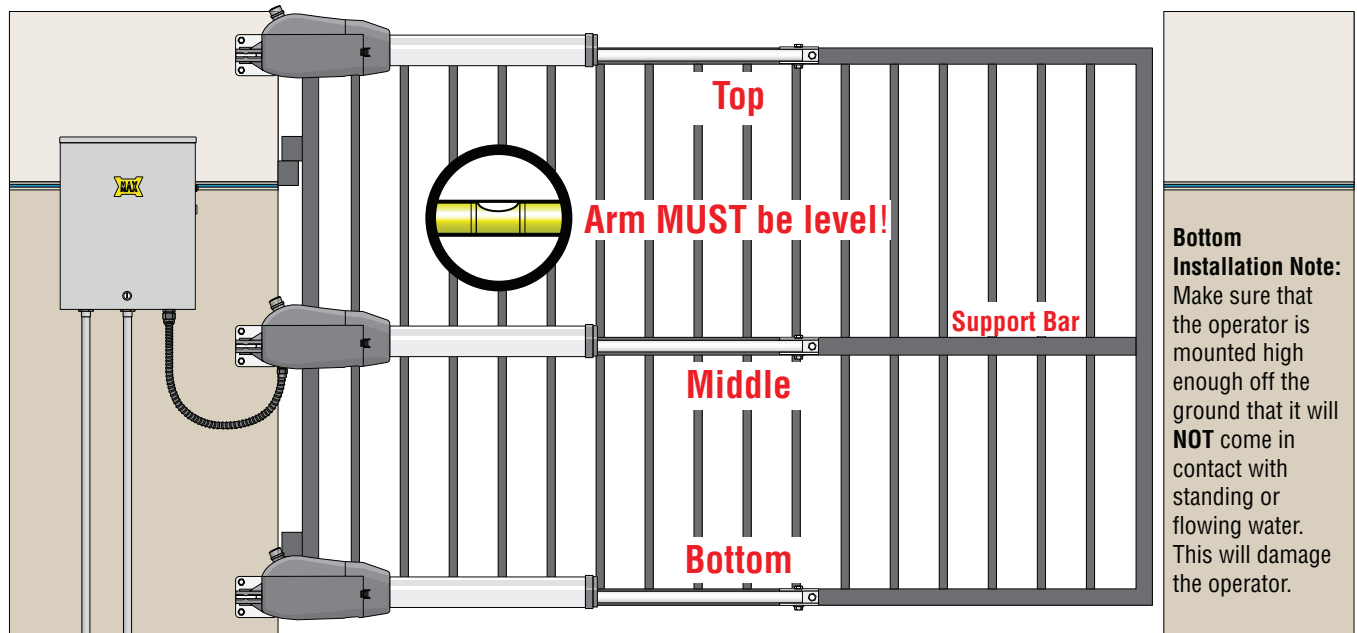

## Gate Support Bar

A support bar that spans the entire length of the gate must be installed to keep the pickets from bending. **Do not mount the front bracket directly to gate pickets!**

## Welding Brackets to Surfaces

If brackets are going to be welded to the gate and/or wall, **only tack weld the brackets with the arm attached. Protect the arm from welding sparks during tack welding. Remove arm before completely welding around the brackets. Make sure the brackets are level when tack welding them!** The arm will not operate properly if not level.

# 1300 PULL OPEN DIMENSIONS

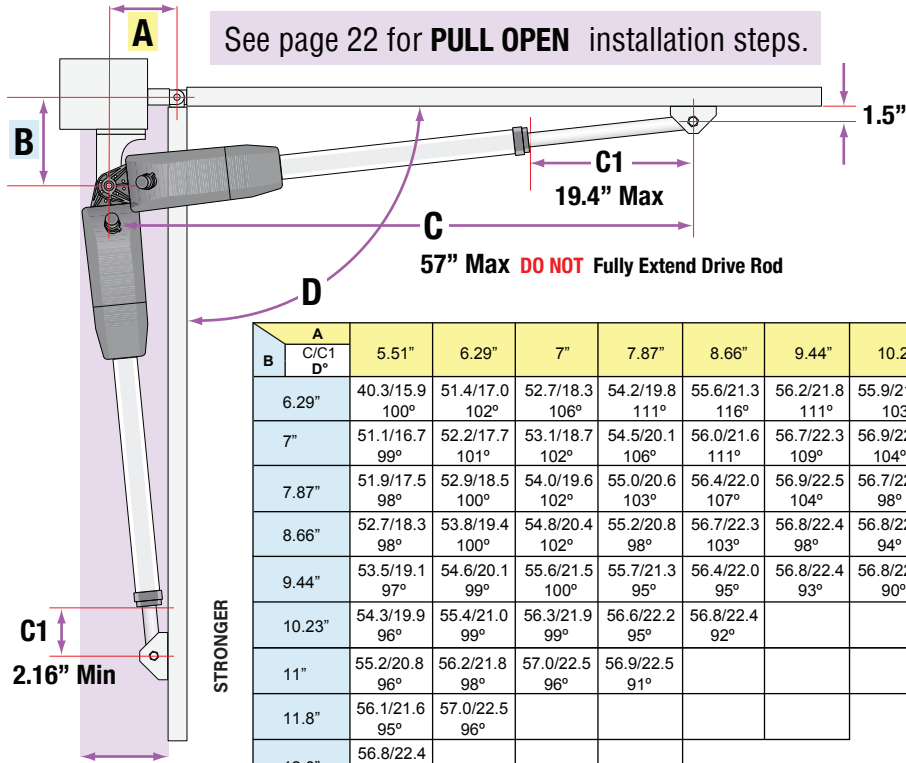

Max Gate Weight/Length	
1300 lbs 589.6 kg	8ft 2.4 m
800 lbs 362.8 kg	10ft 3.0 m
600 lbs 272 kg	12ft 3.6 m

B	A C/C1 D°									
	5.51"	6.29"	7"	7.87"	8.66"	9.44"	10.2"	11"	11.8"	12.6"
6.29"	40.3/15.9 100°	51.4/17.0 102°	52.7/18.3 106°	54.2/19.8 111°	55.6/21.3 116°	56.2/21.8 111°	55.9/21.4 103°	56.5/22.1 102°	56.6/22.2 99°	56.6/22.2 96°
7"	51.1/16.7 99°	52.2/17.7 101°	53.1/18.7 102°	54.5/20.1 106°	56.0/21.6 111°	56.7/22.3 109°	56.9/22.5 104°	56.8/22.4 99°	56.6/22.2 95°	56.5/22.1 92°
7.87"	51.9/17.5 98°	52.9/18.5 100°	54.0/19.6 102°	55.0/20.6 103°	56.4/22.0 107°	56.9/22.5 104°	56.7/22.3 98°	56.8/22.4 95°	56.8/22.4 92°	56.9/22.5 90°
8.66"	52.7/18.3 98°	53.8/19.4 100°	54.8/20.4 102°	55.2/20.8 98°	56.7/22.3 103°	56.8/22.4 98°	56.8/22.4 94°	56.8/22.4 91°		
9.44"	53.5/19.1 97°	54.6/20.1 99°	55.6/21.5 100°	55.7/21.3 95°	56.4/22.0 95°	56.8/22.4 93°	56.8/22.4 90°			
10.23"	54.3/19.9 96°	55.4/21.0 99°	56.3/21.9 99°	56.6/22.2 95°	56.8/22.4 92°					
11"	55.2/20.8 96°	56.2/21.8 98°	57.0/22.5 96°	56.9/22.5 91°						
11.8"	56.1/21.6 95°	57.0/22.5 96°								
12.6"	56.8/22.4 93°									

Max. gate leaf width  
without electric lock  
137.8"

Table in inches

Minimum distance  
needed for clearance

**NOTE for Bi-parting gates using overlap/maglock:**  
Motor 1/Primary gate opens **FIRST**. Install overlap/maglock accordingly to account for this.

# 1300 PUSH OPEN DIMENSIONS

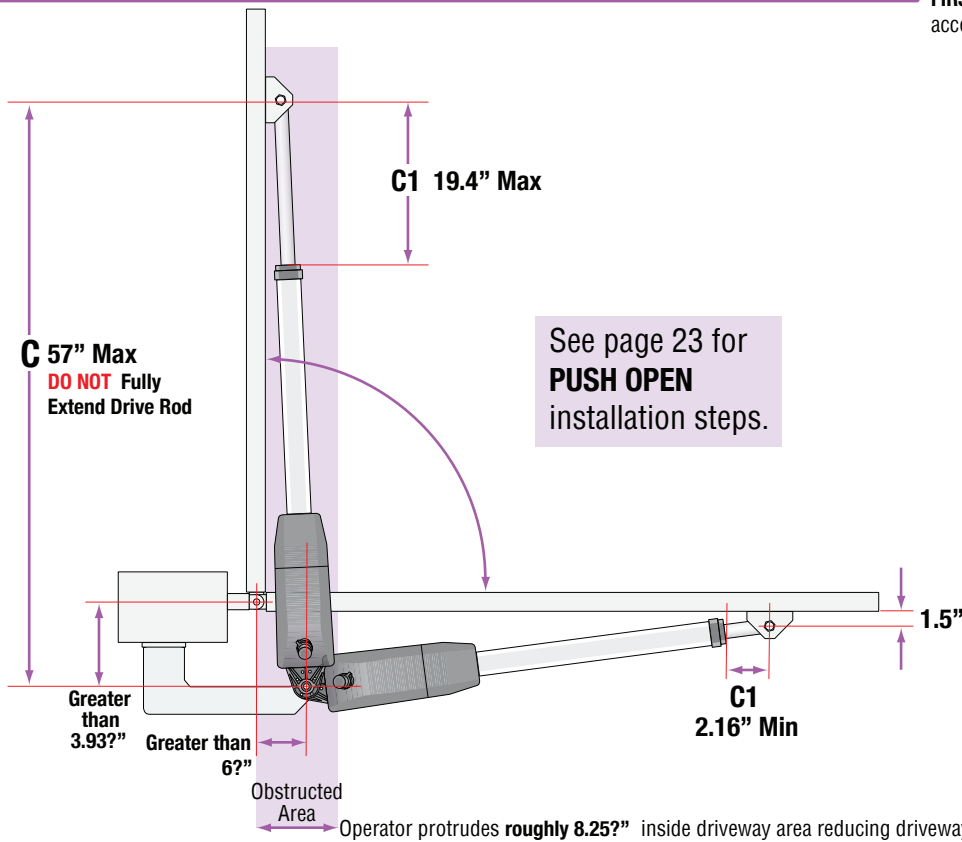

Operator protrudes roughly 8.25" inside driveway area reducing driveway width.

# 1b MOUNT SUPER ARM 2300

## RELEASE 2300 DRIVE ROD

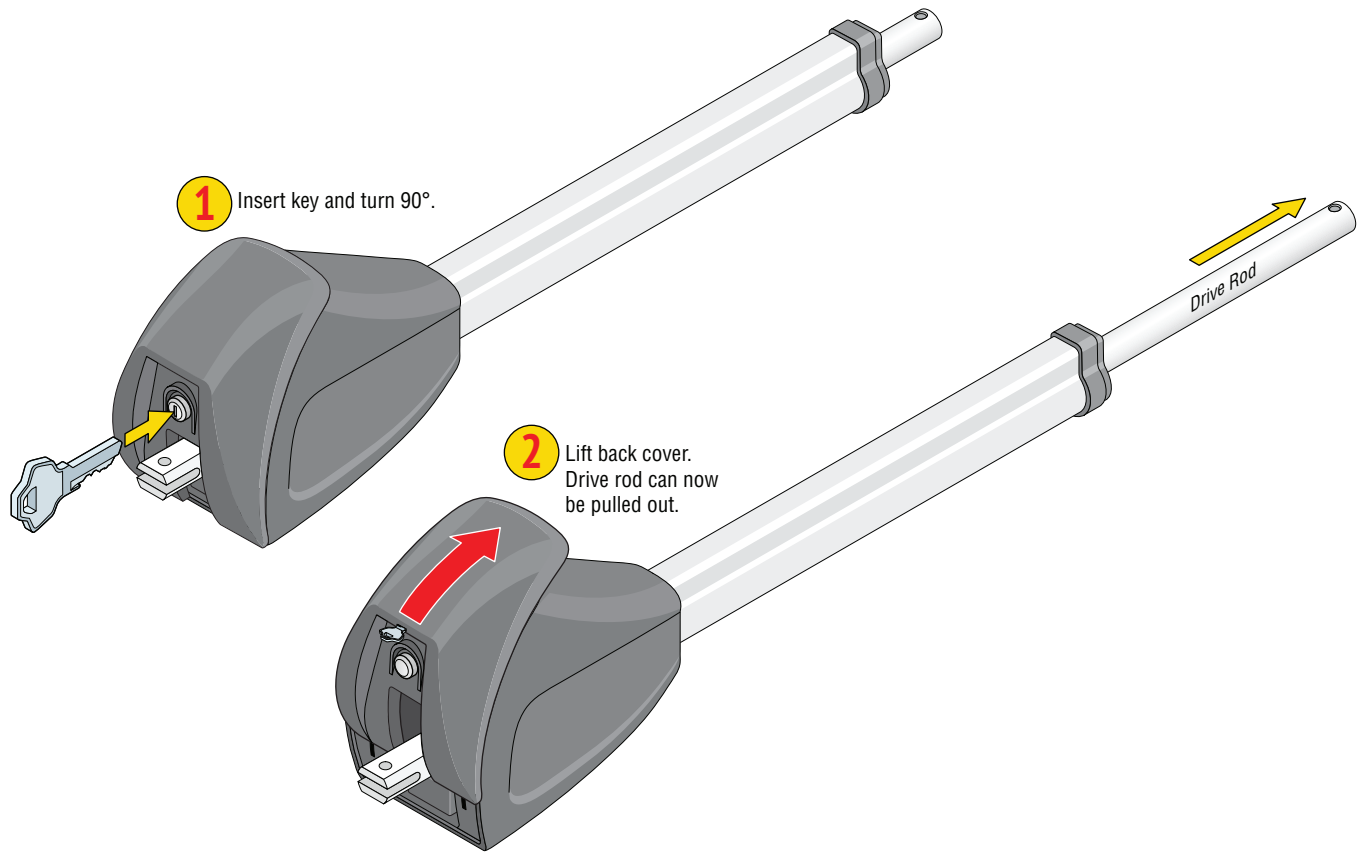

## 2300 BRACKETS

### PULL Open Rear Bracket

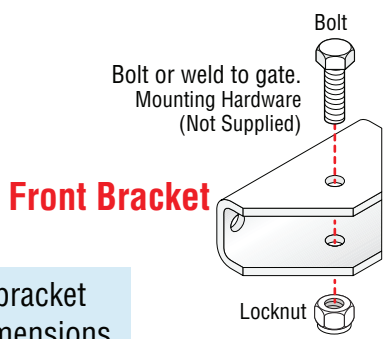
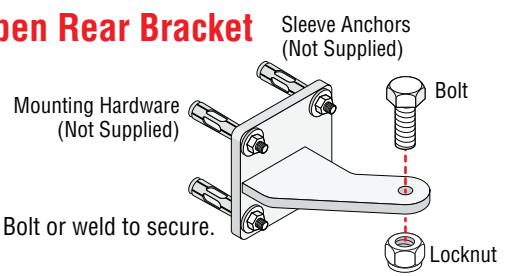

See page 17 for bracket positions and dimensions.

### PUSH Open Rear Bracket

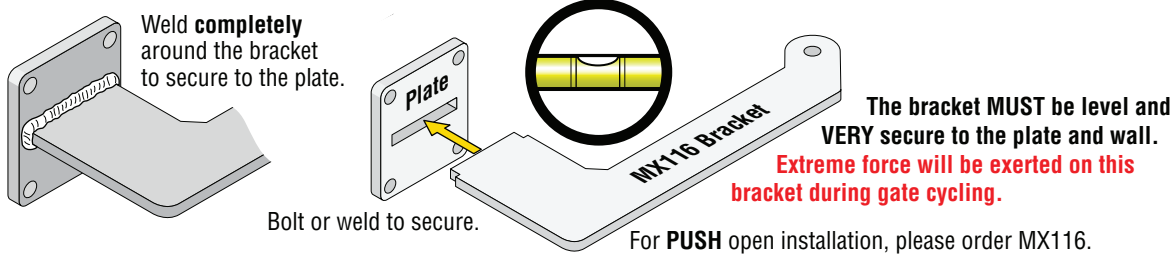

MAX SUPER ARM 2300

# MOUNTING 2300 ARM INFORMATION

Gate must be in good working condition before the actuator arm can be installed. Determine what direction the actuator arm will open the gate: "PULL OPEN" or "PUSH OPEN" Installation (See next page). See the "GATE SAFETY and REQUIREMENTS" in front of this manual (pages 4-11) for mounting requirements and limitations.

## Drive Rod Extension

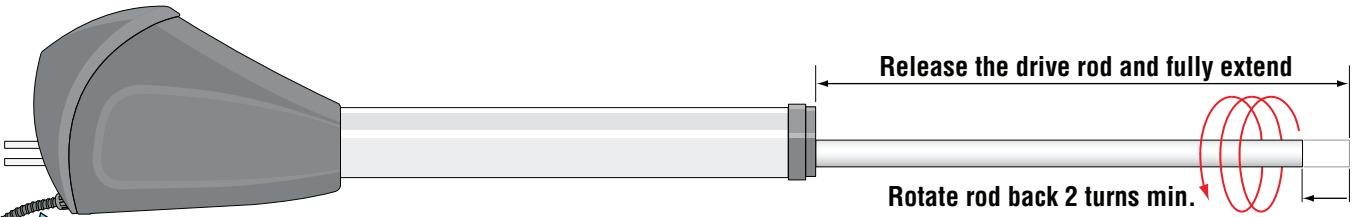

**IMPORTANT:** Drive rod **MUST NOT** be **FULLY** extended when installed. This will damage the arm. Rotate fully extended rod back **at least** two full turns **BEFORE** installing the arm.

## Flex Conduit

The operator wire needs to be in a flexible conduit (not provided).

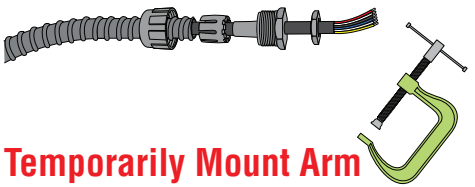

## Temporarily Mount Arm

Temporarily mount arm in desired position determined by next page's dimensions. Manually swing gate to the **OPEN** and **CLOSE** positions. When satisfied with gate positions, permanently mount brackets making sure that arm is **LEVEL**.

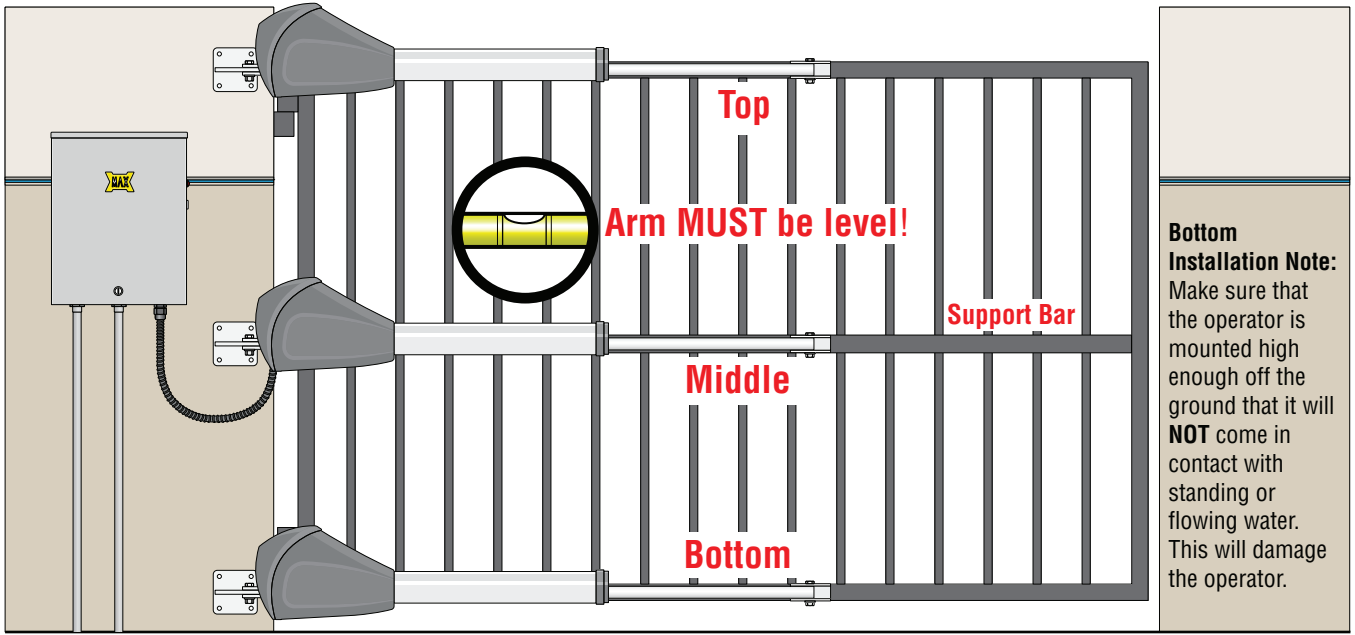

## Gate Support Bar

A support bar that spans the entire length of the gate must be installed to keep the pickets from bending. **Do not mount the front bracket directly to gate pickets!**

## Welding Brackets to Surfaces

If brackets are going to be welded to the gate and/or wall, **only tack weld the brackets with the arm attached. Protect the arm from welding sparks during tack welding. Remove arm before completely welding around the brackets. Make sure the brackets are level when tack welding them!** The arm will not operate properly if not level.

# 2300 PULL OPEN DIMENSIONS

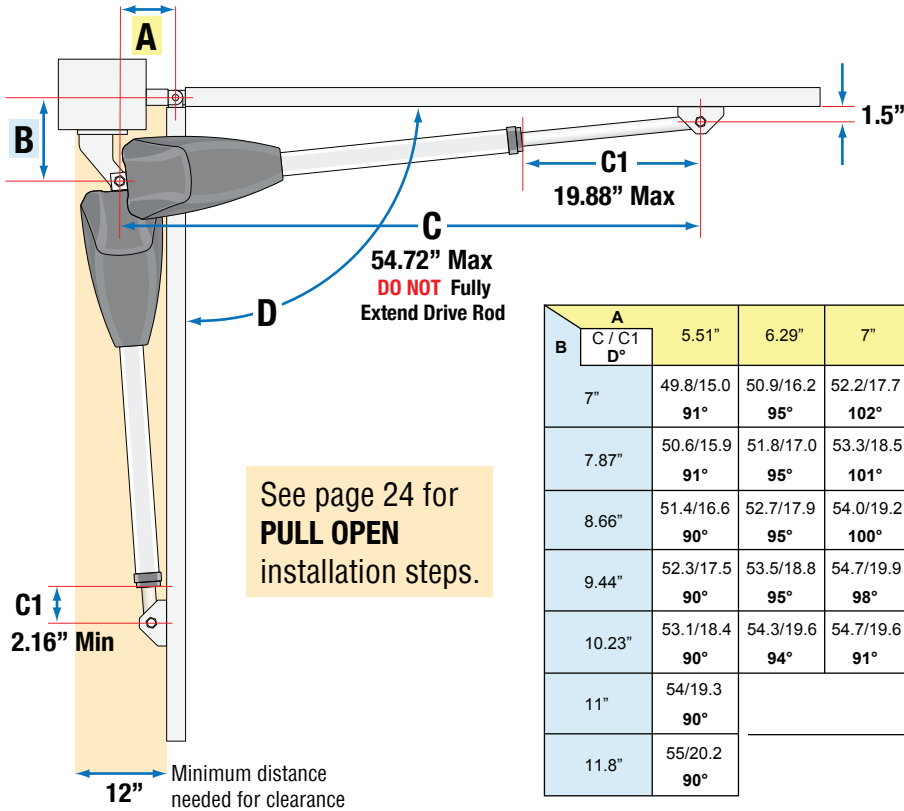

Max Gate Weight/Length			
2300 lbs 1043 kg	2000 lbs 907 kg	1800 lbs 816 kg	1500 lbs 680 kg
8ft 2.4 m	12ft 3.6 m	16ft 4.8 m	20ft 6.0 m

See page 24 for **PULL OPEN** installation steps.

B	A						Max. gate width per gate
	C / C1 D°	5.51"	6.29"	7"	7.87"	8.66"	
7"	49.8/15.0 91°	50.9/16.2 95°	52.2/17.7 102°	54.0/19.3 108°	54.5/19.7 103°	54.2/19.4 96°	157.4"
7.87"	50.6/15.9 91°	51.8/17.0 95°	53.3/18.5 101°	54.4/19.6 103°	54.1/19.4 95°	54.5/19.7 93°	
8.66"	51.4/16.6 90°	52.7/17.9 95°	54.0/19.2 100°	54.5/19.7 97°	54.5/19.7 92°		
9.44"	52.3/17.5 90°	53.5/18.8 95°	54.7/19.9 98°	54.5/19.8 91°			177.2"
10.23"	53.1/18.4 90°	54.3/19.6 94°	54.7/19.6 91°				
11"	54/19.3 90°						
11.8"	55/20.2 90°						196.8"

Table in inches

# 2300 PUSH OPEN DIMENSIONS

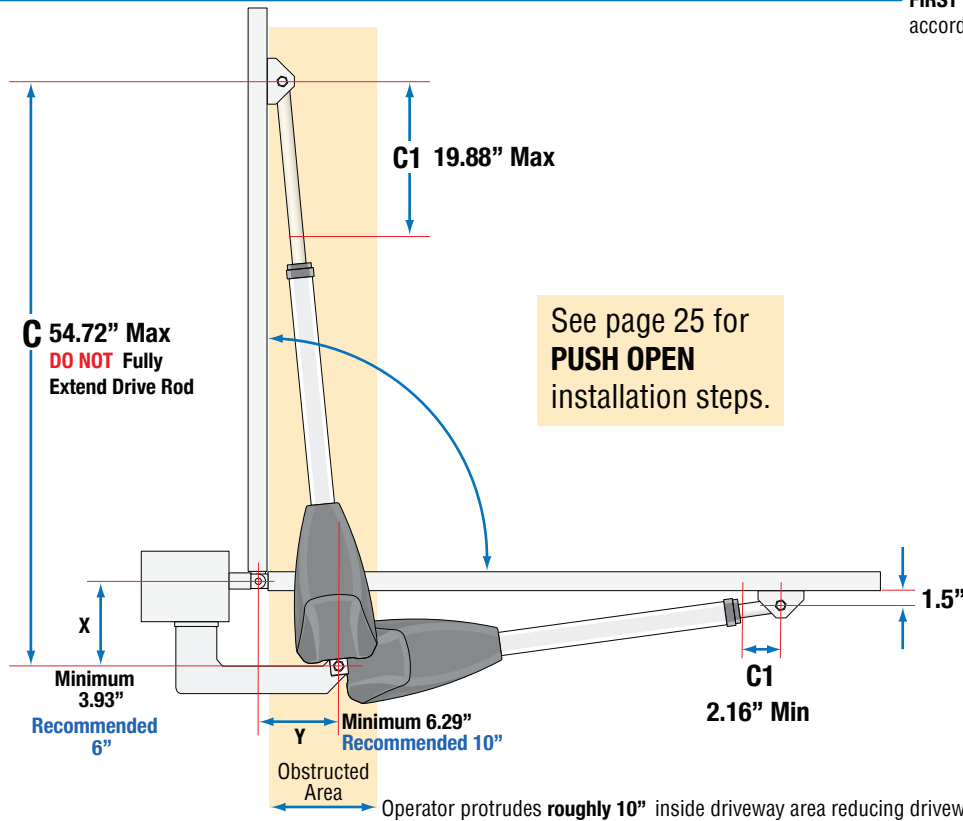

See page 25 for **PUSH OPEN** installation steps.

**NOTE for Bi-parting gates using overlap/maglock:**  
 Motor 1/Primary gate opens **FIRST**. Install overlap/maglock accordingly to account for this.

# 2 MOUNT CONTROL BOX

Mount the control box as near as possible to the actuator arm. Avoid drilling holes in the side or top of the box. Seal any holes made in box to keep out moisture.

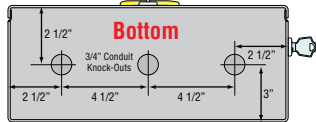
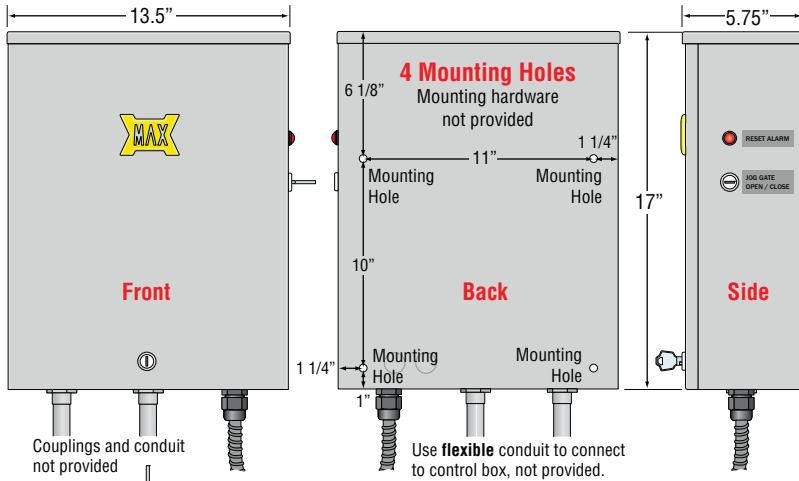

Use the knock-outs to run desired 3/4" conduit. **Never** run low voltage wires in the same conduit as high voltage wire.

**CAREFULLY** remove the delicate control board and other components before mounting box. Use the 4 mounting holes to install box. See components connections to help with re-installation.

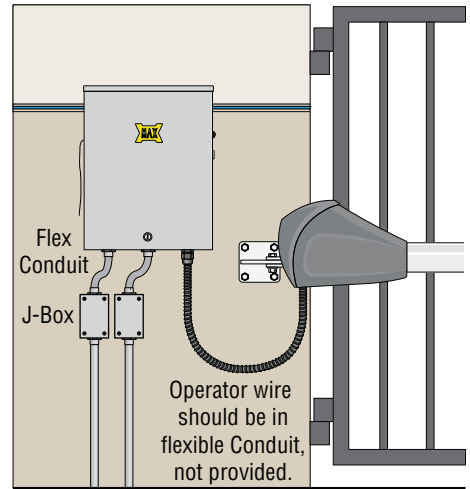

Make sure there is slack in the operator cable. **DO NOT** over-bend the operator cable. Doing this will cause the cable to eventually break. **DO NOT** install near sprinklers or any area that may expose the system to water.

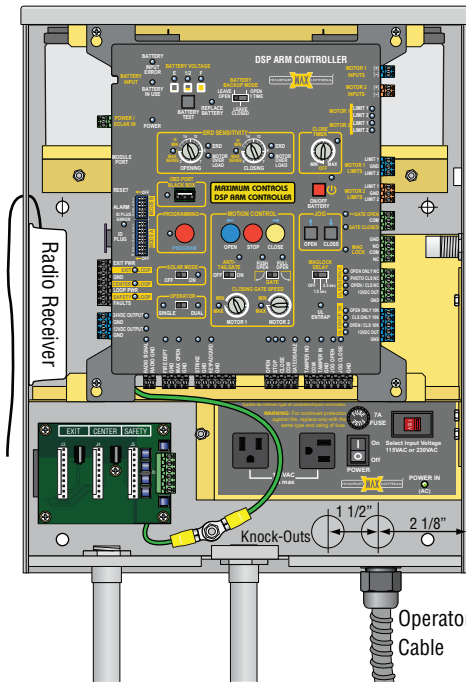

**NOTE:** Operator cable should be in flexible Conduit (not provided).

Please read all the "SAFETY PAGES" in front of this manual (pages 4-11) for installation requirements and restrictions.

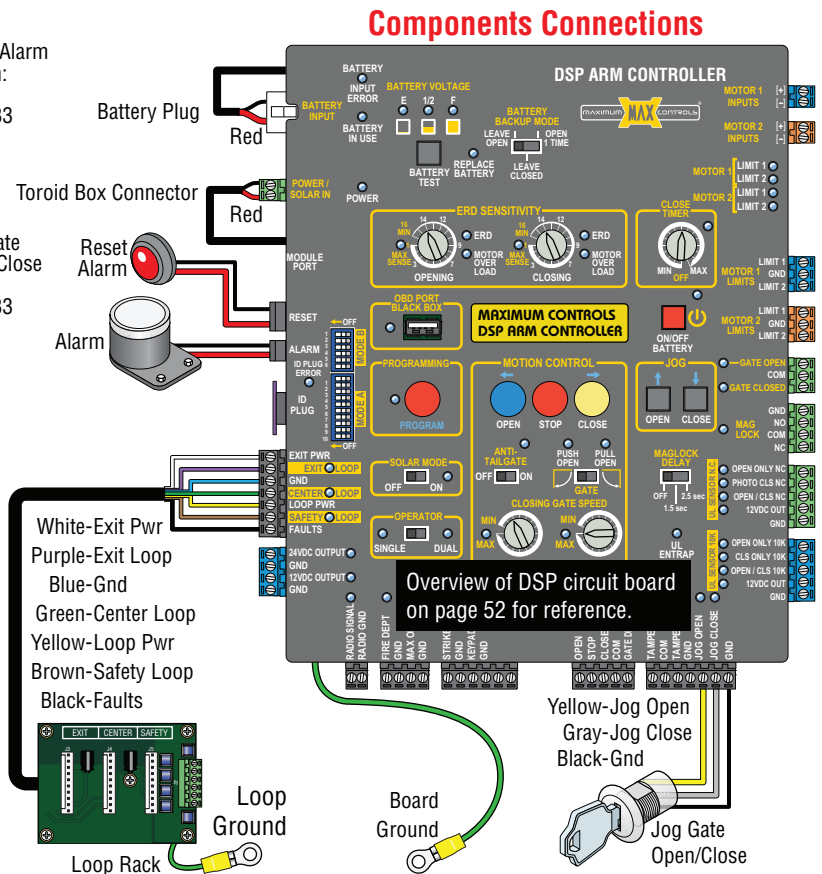

# 3A AC INPUT POWER 115VAC

**NOTE:** IF solar power is being installed, see page 36.

Choose either **115V** or **230V** setting on input AC power selector switch.  
Wire desired input AC power wire to power terminal.

**CAUTION:** Make sure circuit breaker is **OFF** from incoming AC input wire **BEFORE** wiring!

## Input AC Power Options

**CAUTION:** If input AC power selector switch is set for **115V** but input power is actually **230 V**, 7 Amp Fuse will blow.

### Single Phase 115VAC Only

**115VAC**

Set to 115V

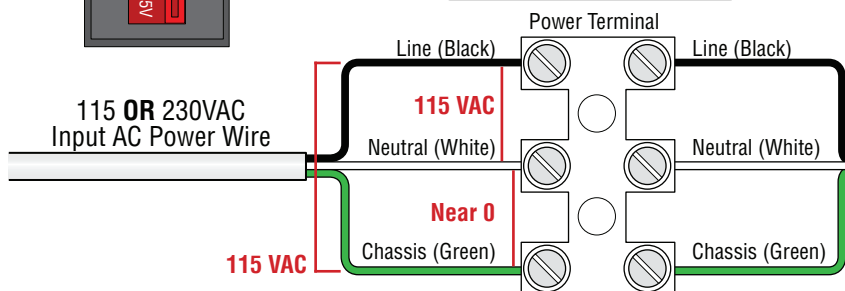

**IMPORTANT:** Make sure there are **NO** exposed bare wires at the power terminal connection.

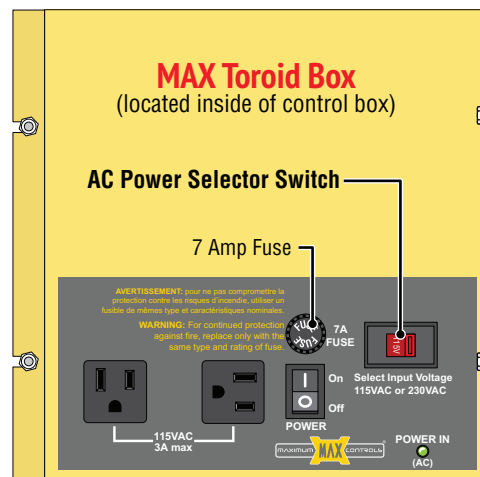

## Turn Power ON

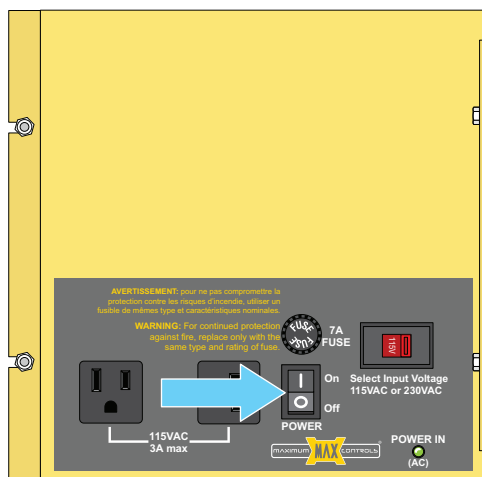

LEDs should light up on DSP board.  
Battery power **automatically** turns **ON**.

## Turn Power OFF

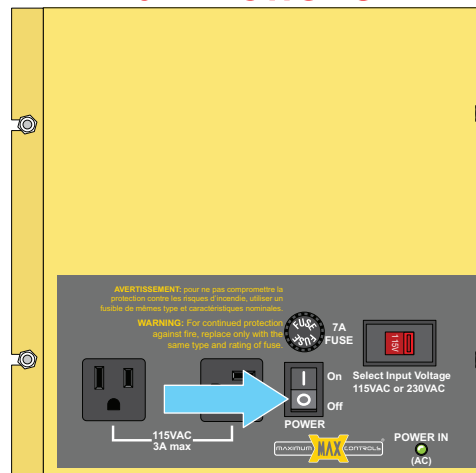

- 1 Turn OFF **POWER** Switch on **MAX Toroid Box**. Battery power will **remain ON**.
- 2 Press and **HOLD** the **RED ON/OFF BATTERY** button on DSP board until beep is heard, then release button.

**IMPORTANT:** This procedure must be followed whenever **ALL** power must be turned **OFF**.



# 3B AC INPUT POWER 230VAC

**CAUTION:** Make sure circuit breaker is OFF from incoming AC input wire BEFORE wiring!

**1** Make sure circuit breaker is OFF for incoming AC input

**2** Set Voltage phase to 230 VAC

**IMPORTANT:** Make sure there are **NO** exposed bare wires at the power terminal connection.

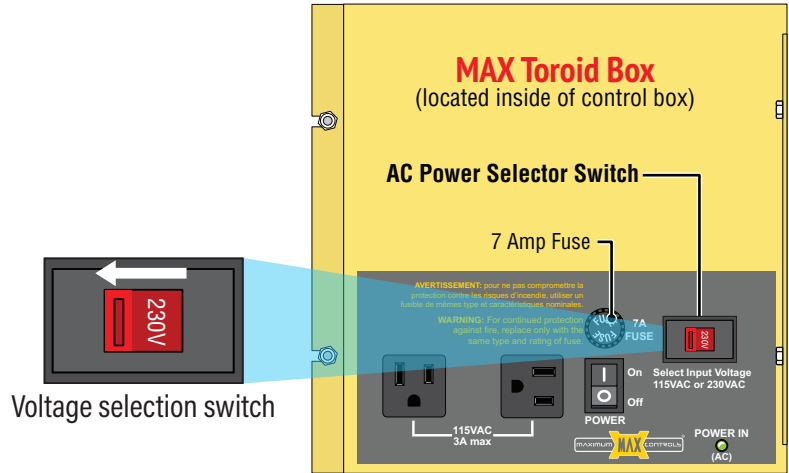

Single Phase 230VAC Only

**230VAC**

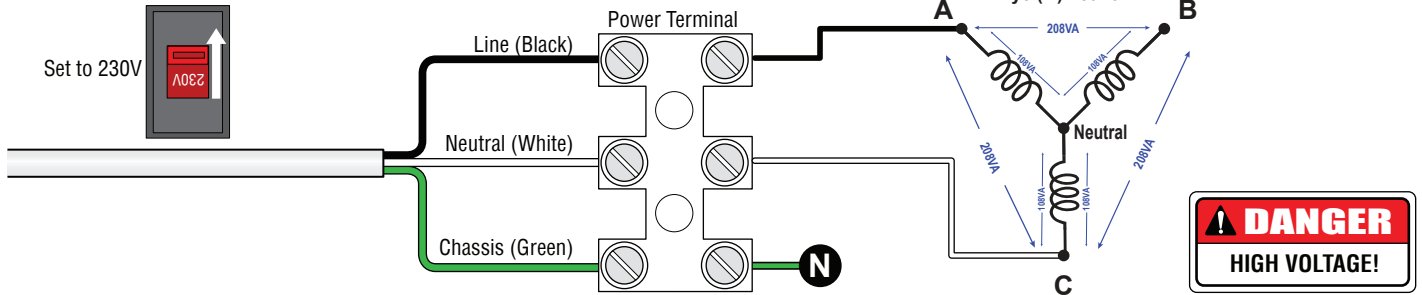

**3** Wiring 230 VAC into power input terminal

- a) 208 VA Wye (Y Network)
- b) 208 VA (Neutral)

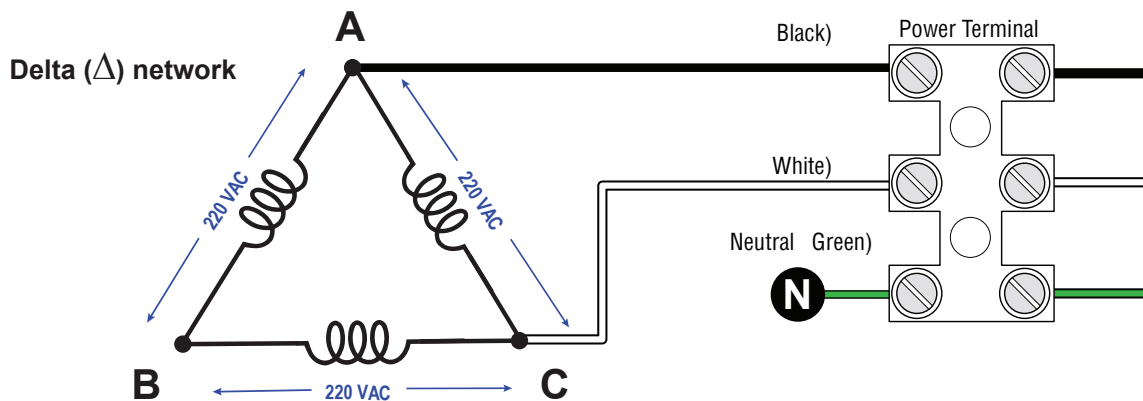

# 4 GROUND CONTROL BOX

## Operator MUST be Properly GROUNDED

**IMPORTANT:** Operator MUST be grounded in lightning prone areas or warranty will be **VOIDED!**

Proper grounding of this control box is a requirement for **LIGHTNING PROTECTION** in lightning prone areas. To be effective, ground connections should be made with a **minimum 12 AWG, 600 volt** insulated wire to a ground point within **10 feet of the control box**. The ground point must be at an **electrical panel**, a **metallic cold water pipe** that runs in the earth, or a **grounding rod**.

**NOTE:** Consult city codes for AC line wiring. Beware of existing underground services.

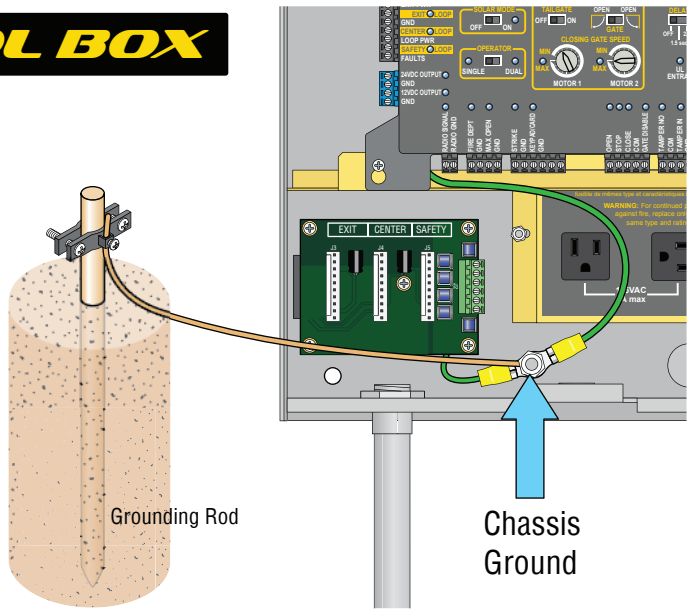

# 5 WIRE ARM(S) TO DSP BOARD

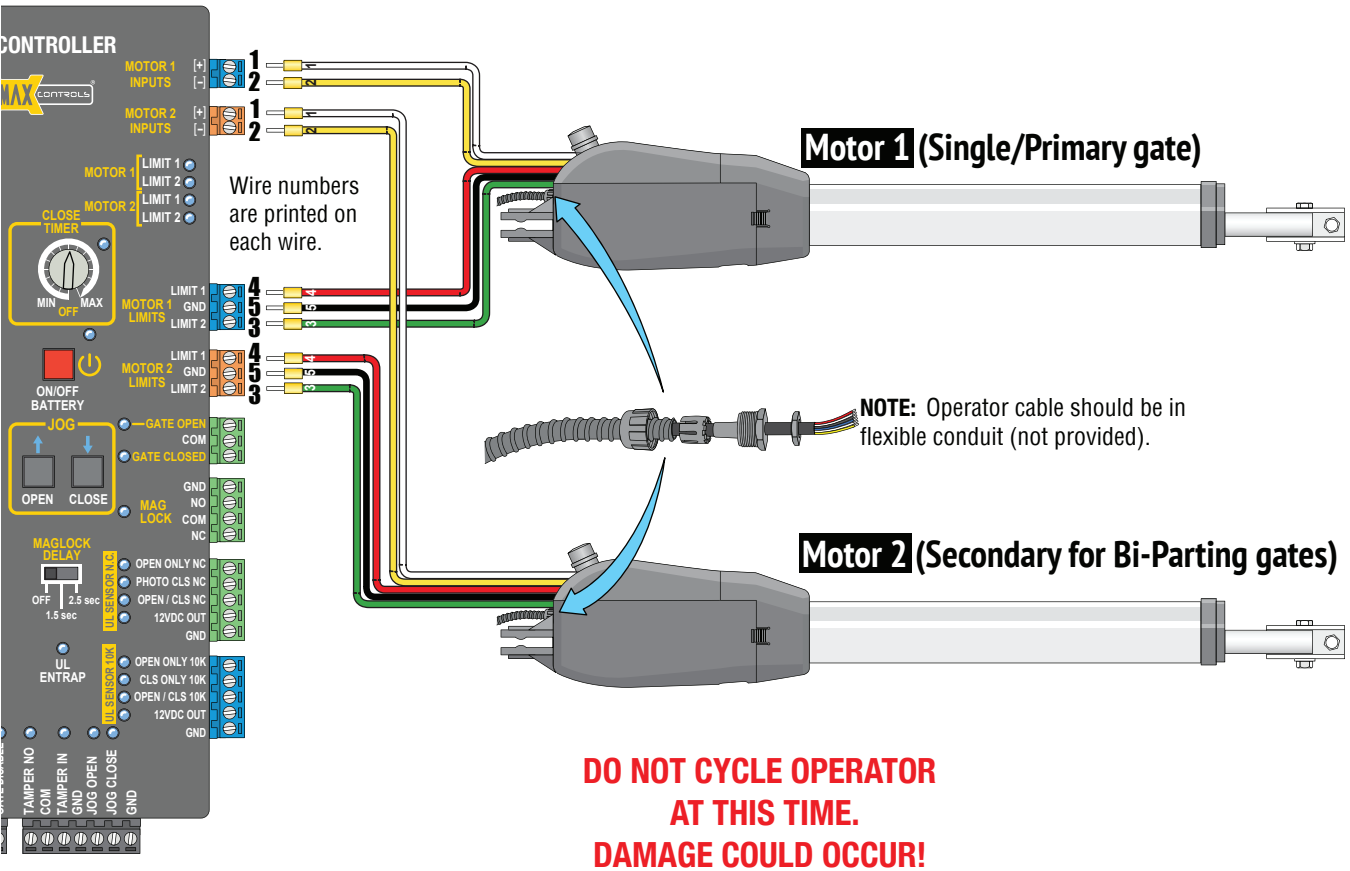

# 6 SETTINGS: GATE/ID PLUG/OPERATOR

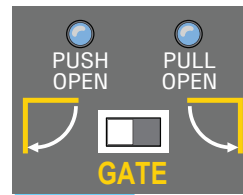
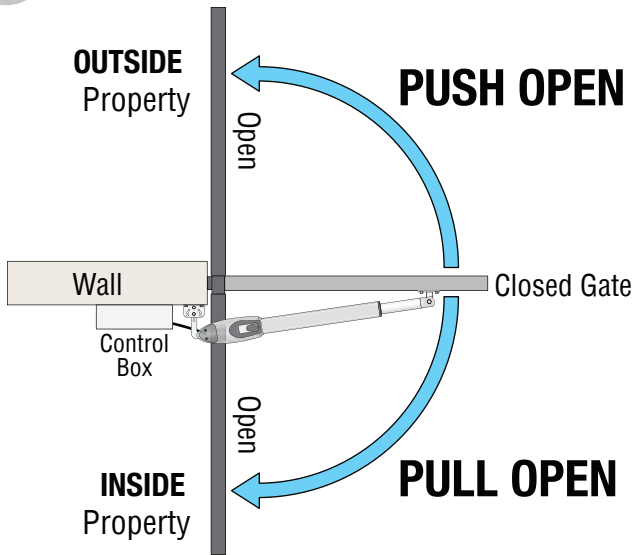

**Gate:**  
Set the desired opening direction.  
See the illustration and next pages.

**ID Plug Error:** If ID plug is **NOT** plugged in, board will constantly beep and arm will **NOT** function.

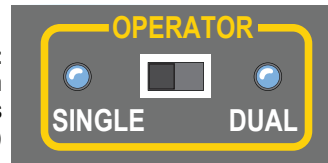

**Operator:**  
Set operator to **SINGLE** for a single arm  
Set operator to **Dual** for a bi-parting gates  
(see page 32 for bi-parting gates)

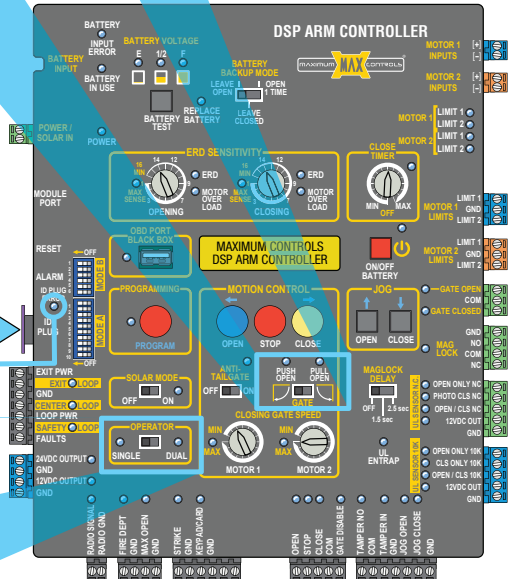

# 7 ACTUATOR TYPE

Mode B DIP-switch 6



Switch 4 & 5

MODE B Switches	Soft Start/ Stop Selection	Short	4 & 5 OFF	1
4 & 5		Medium Short	4 ON 5 OFF	2
		Medium Long	4 OFF 5 ON	3
		Long	4 & 5 ON	4

Best to keep in shorter setting but if gate motion needs to be smoothen out at the end, try lengthening the setting incrementally.

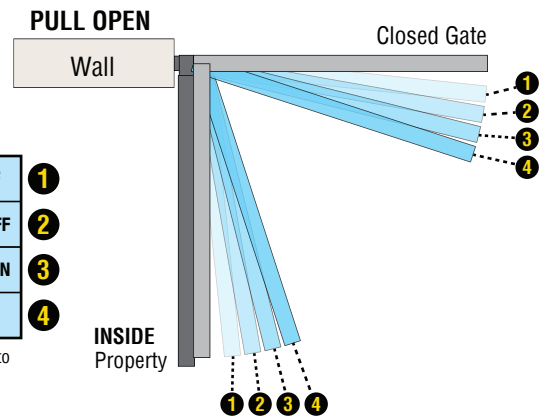

# 8 GATE LIMIT ADJUSTMENTS

Adjust the limits for **OPEN** and **CLOSE** gate positions depending on **GATE** setting for **your chosen operator model** on the next 4 pages. **Mode B** DIP-switches 4&5 **MUST** be set correctly for your gate length. See step 7 above.

**PULL or PUSH Open**

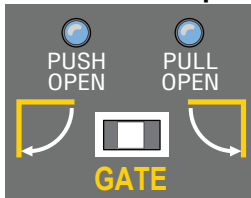

**PULL OPEN** configuration:  
- **LIMIT 1** is **OPEN** limit  
- **LIMIT 2** is **CLOSE** limit

**PUSH OPEN** configuration:  
- **LIMIT 1** is **CLOSE** limit  
- **LIMIT 2** is **OPEN** limit

**Limit LEDs**

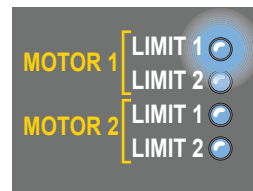

**“BEEP”**

With gate in the exact **Close** and then **OPEN** positions respectively, adjust each limit until the appropriate **LED lights up** and a **BEEP** is heard for each gate limit position (follow the steps on the next 4 pages depending on your model operator).

# PULL OPEN 1300 INSTALL

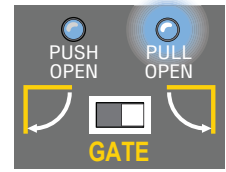

**Operator MUST be wired to control box. Control box MUST have power.**

1. Clear limits from control box memory. Press and **HOLD STOP** and **CLOSE** buttons **together** for 5 sec. until **BEEP/ALARM** is heard. Screen will display **“LEARNING LIMITS”**.



2. Mount actuator arm on **REAR** bracket **ONLY**.  
**Rear bracket already secured to gate post**



3. **Manually release** actuator arm. See page 12.



4. Retract shaft until a **BEEP/ALARM** is heard from control box.

5. Extend shaft to **3 1/4"** (typical) as shown. This will be **OPEN** position of operator.

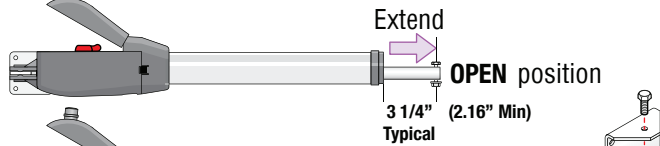

6. Bolt **FRONT** bracket to operator.

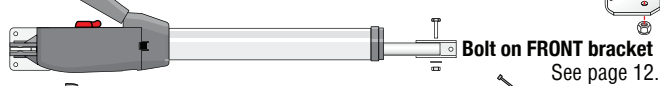

7. Manually move gate to **OPEN** position.

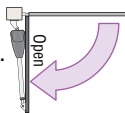

8. With operator shaft in same position, **temporarily** mount **FRONT** bracket (Clamp or tack weld) to gate in the **OPEN** position.



9. Make sure gate remains in **OPEN** position. Rotate **OPEN** limit screw until **BEEP/ALARM** is heard.

**NOTE:** Rotate **OPEN** limit screw in **“MINUS”** direction for gate to open **LESS**. Rotate **OPEN** limit screw in **“PLUS”** direction for gate to open **FURTHER**.

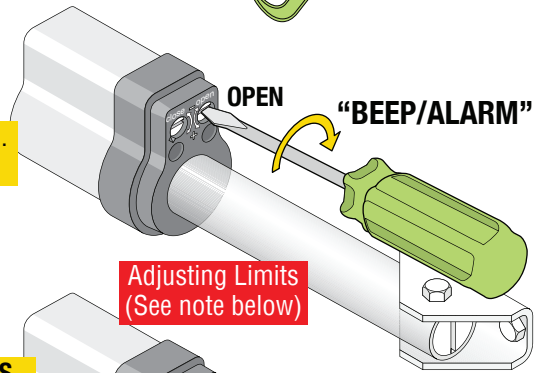

10. Manually move gate to **CLOSE** position.

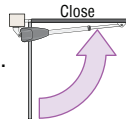

11. Rotate **CLOSE** limit screw until **BEEP/ALARM** is heard.

**NOTE:** Rotate **CLOSE** limit screw in **“MINUS”** direction for gate to close **LESS**. Rotate **CLOSE** limit screw in **“PLUS”** direction for gate to close **FURTHER**.

**CAUTION:** If **BEEP/ALARM** is **NOT** heard, readjust front bracket position.

**NOTE:** If 2 consecutive **BEEP/ALARMS** are heard when moving gate to **CLOSED** position, then adjust gate to **FIRST** **BEEP/ALARM** position.

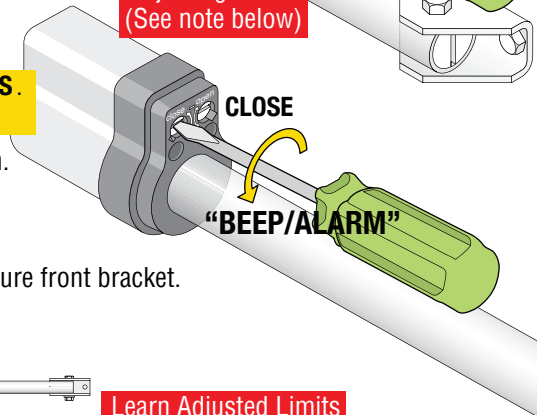

12. When satisfied with Open and Close positions of gate, **permanently** secure front bracket.

13. Re-lock Manual release.



14. Learn newly adjusted limits on control box. Push the **OPEN** button, gate will open and learn open limit. Push the **CLOSE** button, gate will close and learn close limit.

**NOTE:** Gate **may not** ramp down when approaching limits while **“LEARNING”** gate positions but **will** ramp down **after** limits have been learned.

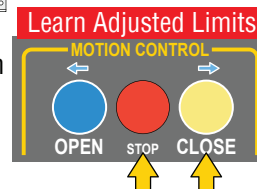

**NOTE:** If limits need to be **re-adjusted**, then they **MUST** be cleared first from control box memory, see **#1** above.

# PUSH OPEN 1300 INSTALL

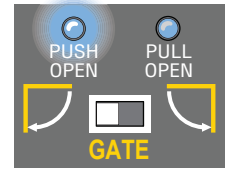

**Operator MUST be wired to control box. Control box MUST have power.**

1. Clear limits from control box memory. Press and **HOLD STOP** and **CLOSE** buttons **together** for 5 sec. until **BEEP/ALARM** is heard. Screen will display **"LEARNING LIMITS"**.



2. Mount actuator arm on **REAR** bracket **ONLY**.  
**Rear bracket already secured to gate post**

3. **Manually release** actuator arm. See page 12.

4. Retract shaft until a **BEEP/ALARM** is heard from control box.

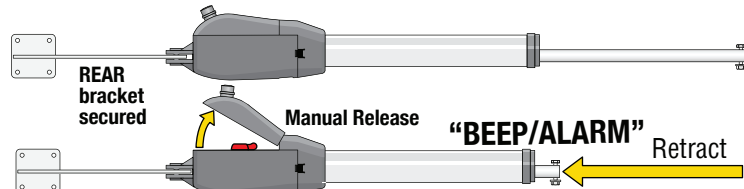

5. Extend shaft to **3 1/4"** (typical) as shown. This will be **CLOSE** position of operator.

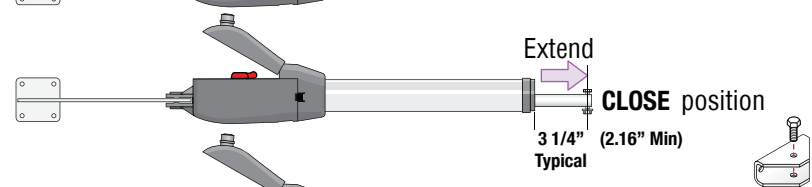

6. Bolt **FRONT** bracket to operator.

7. Manually move gate to **CLOSE** position.

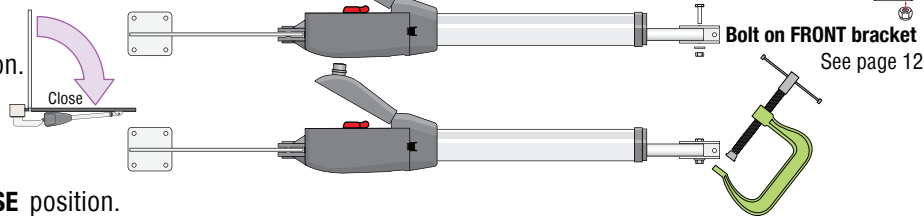

8. With operator shaft in same position, **temporarily** mount **FRONT** bracket (Clamp or tack weld) to gate in the **CLOSE** position.

9. Make sure gate remains in **CLOSE** position. Rotate **OPEN** limit screw until **BEEP** is heard. (Open limit screw is adjusted for the **CLOSE** position of gate)

**NOTE:** Rotate **OPEN** limit screw in **"MINUS"** direction for gate to close **LESS**. Rotate **OPEN** limit screw in **"PLUS"** direction for gate to close **FURTHER**.

10. Manually move gate to **OPEN** position.

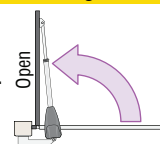

11. Rotate **CLOSE** limit screw until **BEEP/ALARM** is heard. (Close limit screw is adjusted for the **OPEN** position of gate)

**NOTE:** Rotate **CLOSE** limit screw in **"MINUS"** direction for gate to open **LESS**. Rotate **CLOSE** limit screw in **"PLUS"** direction for gate to open **FURTHER**.

**CAUTION:** If **BEEP/ALARM** is **NOT** heard, readjust front bracket position.

**NOTE:** If 2 consecutive beeps are heard when moving gate to **OPEN** position, then adjust gate to **FIRST** BEEP/ALARM position.

12. When satisfied with Open and Close positions of gate, **permanently** secure front bracket.

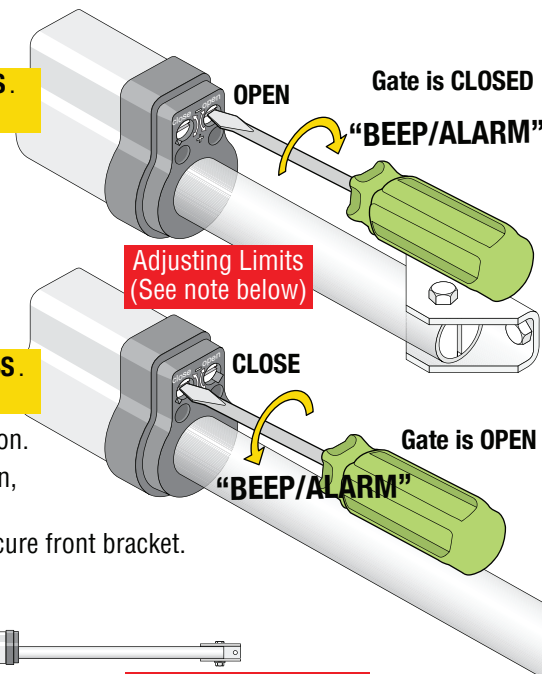

13. Re-lock Manual release.

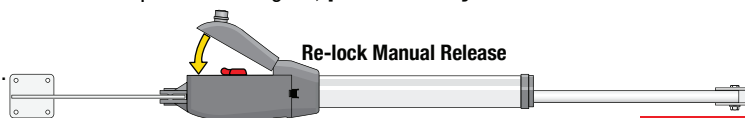

14. Learn newly adjusted limits on control box. Push the **OPEN** button, gate will open and learn open limit. Push the **CLOSE** button, gate will close and learn close limit.

**NOTE:** Gate **may not** ramp down when approaching limits while **"LEARNING"** gate positions but **will** ramp down **after** limits have been learned.

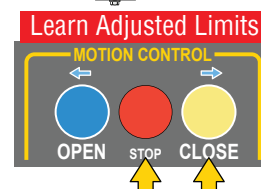

**NOTE:** If limits need to be **re-adjusted**, then they **MUST** be cleared first from control box memory, see #1 above.

# PULL OPEN 2300 INSTALL

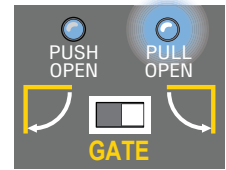

**Operator MUST be wired to control box. Control box MUST have power.**

1. Clear limits from control box memory. Press and **HOLD STOP** and **CLOSE** buttons **together** for 5 sec. until **BEEP/ALARM** is heard. Screen will display **“LEARNING LIMITS”**.



2. Mount actuator arm on **REAR** bracket **ONLY**.  
**Rear bracket already secured to gate post**



3. **Manually release** actuator arm. See page 15.

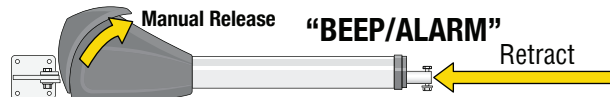

4. Retract shaft until a **BEEP/ALARM** is heard from control box.

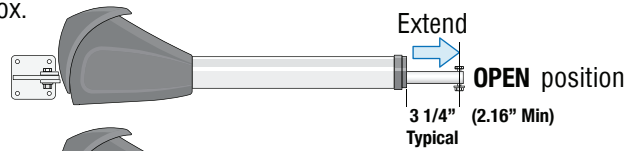

5. Extend shaft to **3 1/4"** (typical) as shown. This will be **OPEN** position of operator.

6. Bolt **FRONT** bracket to operator.

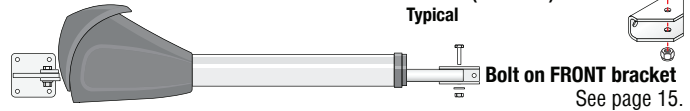

7. Manually move gate to **OPEN** position.

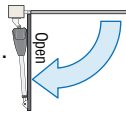

8. With operator shaft in same position, **temporarily** mount **FRONT** bracket (Clamp or tack weld) to gate in the **OPEN** position.



9. Make sure gate remains in **OPEN** position. Rotate **OPEN** limit screw until **BEEP/ALARM** is heard.

**NOTE:** Rotate **OPEN** limit screw in **“MINUS”** direction for gate to open **LESS**. Rotate **OPEN** limit screw in **“PLUS”** direction for gate to open **FURTHER**.

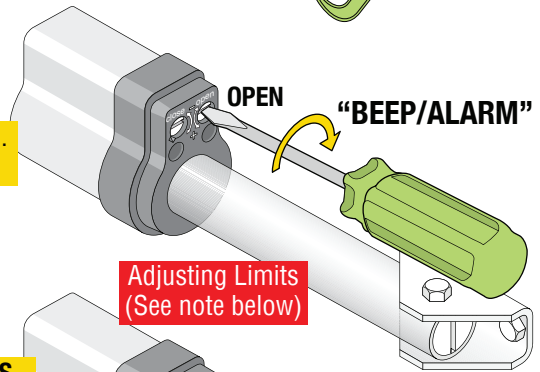

10. Manually move gate to **CLOSE** position.

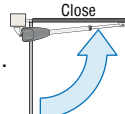

11. Rotate **CLOSE** limit screw until **BEEP/ALARM** is heard.

**NOTE:** Rotate **CLOSE** limit screw in **“MINUS”** direction for gate to close **LESS**. Rotate **CLOSE** limit screw in **“PLUS”** direction for gate to close **FURTHER**.

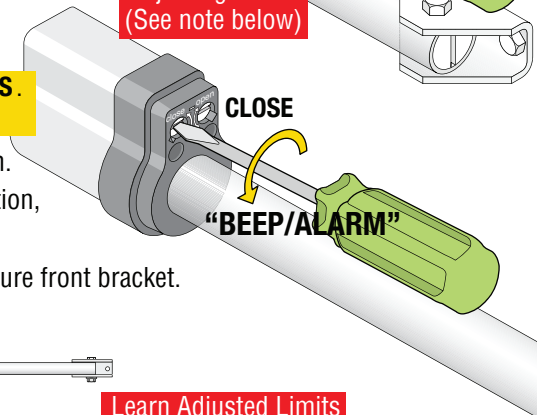

**CAUTION:** If **BEEP/ALARM** is **NOT** heard, readjust front bracket position.

**NOTE:** If 2 consecutive beeps are heard when moving gate to **CLOSED** position, then adjust gate to **FIRST** BEEP/ALARM position.

12. When satisfied with Open and Close positions of gate, **permanently** secure front bracket.

13. Re-lock Manual release.



14. Learn newly adjusted limits on control box. Push the **OPEN** button, gate will open and learn open limit. Push the **CLOSE** button, gate will close and learn close limit.

**NOTE:** Gate **may not** ramp down when approaching limits while **“LEARNING”** gate positions but **will** ramp down **after** limits have been learned.

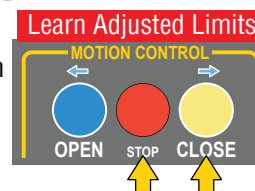

**NOTE:** If limits need to be **re-adjusted**, then they **MUST** be cleared first from control box memory, see #1 above.

# PUSH OPEN 2300 INSTALL

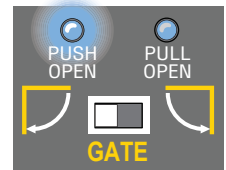

**Operator MUST be wired to control box. Control box MUST have power.**

1. Clear limits from control box memory. Press and **HOLD STOP** and **CLOSE** buttons **together** for 5 sec. until **BEEP/ALARM** is heard. Screen will display **"LEARNING LIMITS"**.



2. Mount actuator arm on **REAR** bracket **ONLY**.  
**Rear bracket already secured to gate post**

3. **Manually release** actuator arm. See page 15.

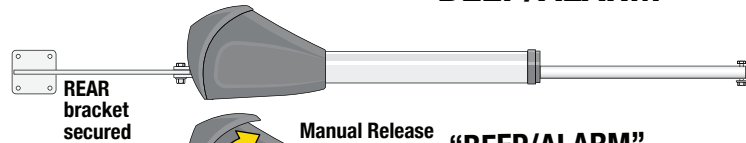

4. Retract shaft until a **BEEP/ALARM** is heard from control box.

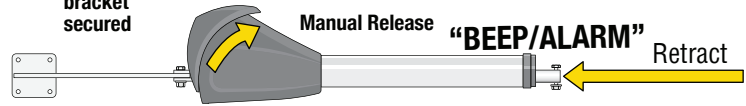

5. Extend shaft to **3 1/4"** (typical) as shown. This will be **CLOSE** position of operator.



6. Bolt **FRONT** bracket to operator.

7. Manually move gate to **CLOSE** position.

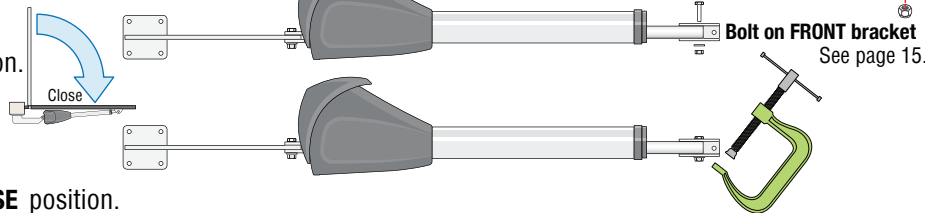

8. With operator shaft in same position, **temporarily** mount **FRONT** bracket (Clamp or tack weld) to gate in the **CLOSE** position.

9. Make sure gate remains in **CLOSE** position. Rotate **OPEN** limit screw until **BEEP** is heard. (Open limit screw is adjusted for the **CLOSE** position of gate)

**NOTE:** Rotate **OPEN** limit screw in **"MINUS"** direction for gate to close **LESS**.  
 Rotate **OPEN** limit screw in **"PLUS"** direction for gate to close **FURTHER**.

10. Manually move gate to **OPEN** position.

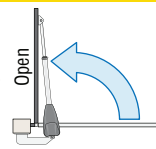

11. Rotate **CLOSE** limit screw until **BEEP/ALARM** is heard. (Close limit screw is adjusted for the **OPEN** position of gate)

**NOTE:** Rotate **CLOSE** limit screw in **"MINUS"** direction for gate to open **LESS**.  
 Rotate **CLOSE** limit screw in **"PLUS"** direction for gate to open **FURTHER**.

**CAUTION:** If **BEEP/ALARM** is **NOT** heard, readjust front bracket position.

**NOTE:** If 2 consecutive **BEEP/ALARMS** are heard when moving gate to **OPEN** position, then adjust gate to **FIRST** **BEEP/ALARM** position.

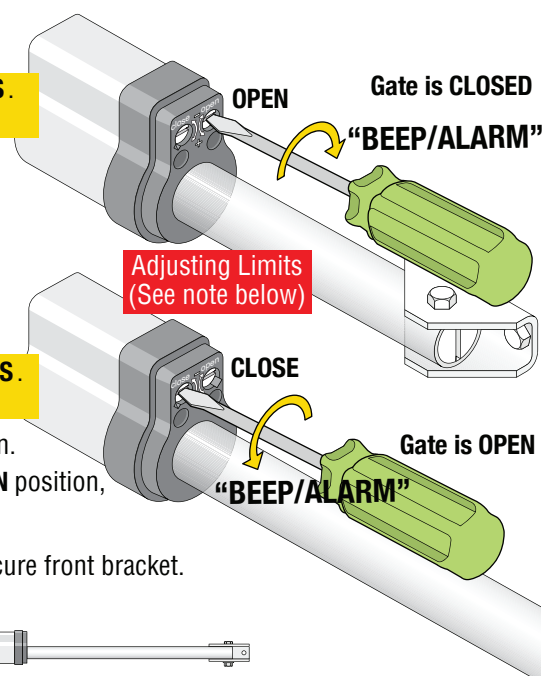

12. When satisfied with Open and Close positions of gate, **permanently** secure front bracket.

13. Re-lock Manual release.



14. Learn newly adjusted limits on control box. Push the **OPEN** button, gate will open and learn open limit. Push the **CLOSE** button, gate will close and learn close limit.

**NOTE:** Gate **may not** ramp down when approaching limits while **"LEARNING"** gate positions but **will** ramp down **after** limits have been learned.

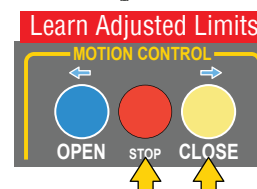

**NOTE:** If limits need to be **re-adjusted**, then they **MUST** be cleared first from control box memory, see #1 above.

# 9

## ENTRAPMENT PROTECTION LOCATIONS

At least **ONE** entrapment protection device **MUST** be installed or the operator will **NOT** function. Typically it is the **CLOSING** direction photocell. Entrapment sensors **MUST** be installed in **BOTH** opening and closing direction of gate movement where entrapment or pinch point exist.

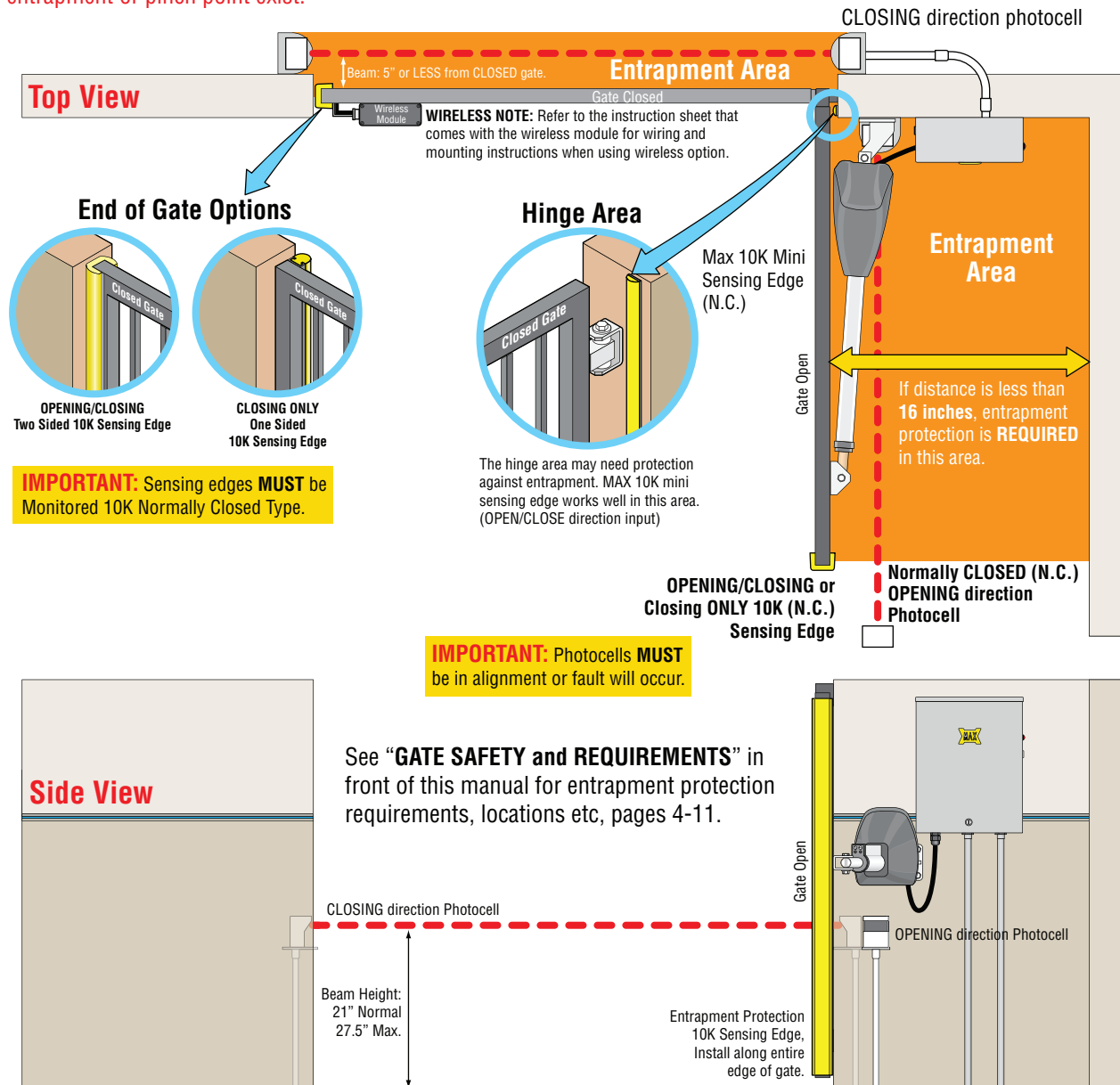

## LIST OF SENSORS - UL325 2018

The following is a list of recommended safety devices for the MAX Arm Operators (sold separately).

- Omron E3K-R10K4-10R Photocell (Reflector)
- EMX IRB-MON Photocell (Thru-Beam)
- EMX IRB-RET Photocell (Reflector)
- EMX Wireless Edge Link WEL-200T / WEL-200R
- Enforcer E931-S50RRGQ Photocell (Reflector)
- Enforcer E960-G90GQ Twin Beam (Thru-Beam)
- Miller Edge Prime Guard Photocell (Thru-Beam)
- Miller Edge GEM-104 10K to NC Converter

- Miller Edge R-Band Wireless Edge Unit  
P/N: RB-G-RX10 & RB-TX10
- Transmitter Solutions IGAZER50LR-UL Photocell (Reflector)
- Transmitter Solutions IGAZESR66HD Photocell (Thru-Beam)
- Transmitter Solutions Wireless Edge Sensor Model: RCO0900  
P/N: IGAZEREKIT-UL
- ASO Edge MAX Mini Edge Contact Edge Sensor
- ASO Edge Thin Edge MAX Edge 1 Contact Edge Sensor

# 10 ENTRAPMENT PROTECTION WIRING

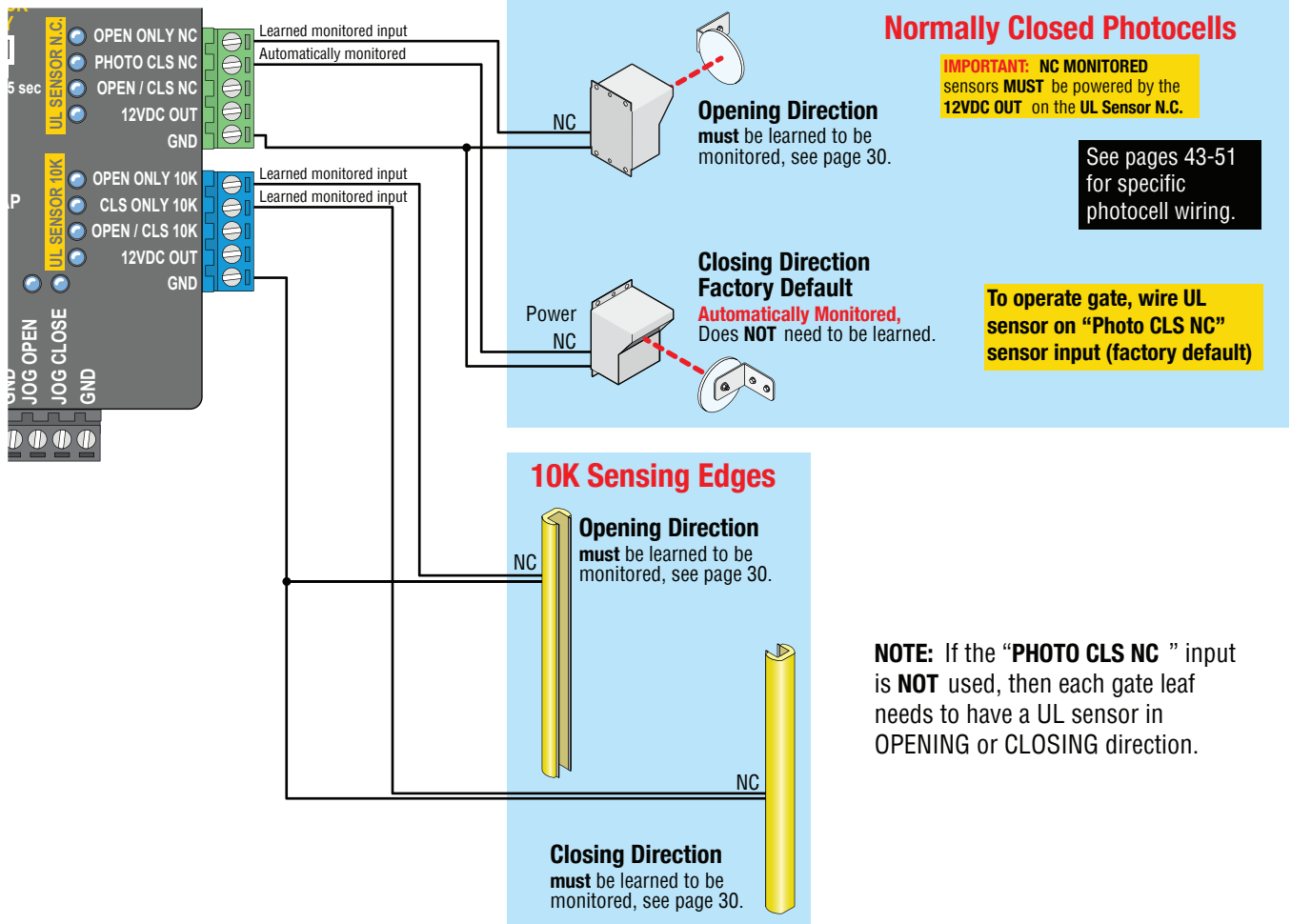

## TEST PHOTO CLS NC SENSOR

Test **PHOTO CLS NC** entrapment protection sensor (Photocell typically used):

1. Press and **HOLD** the **STOP** button & then the **OPEN** button together until beeping is heard, learn mode begins.

**NOTE: DO NOT** press the **OPEN** button before the **STOP** button or learn mode will **NOT** function.

2. **PHOTO CLS NC** LED should be **ON** if an entrapment sensor is detected. If **PHOTO CLS NC** LED is **NOT** on, sensor has a problem.

**Possible problems:**

- Photocell are out of alignment.
- Photocell is wired wrong - N.C. or N.O. depending on which type of photocell is used.
- Sensor is bad.

3. Press **STOP** button again within 5 min. to end learn mode, beeping stops.

**NOTE:** If **STOP** button is not pressed within 5 min. learn mode automatically end after 5 min.

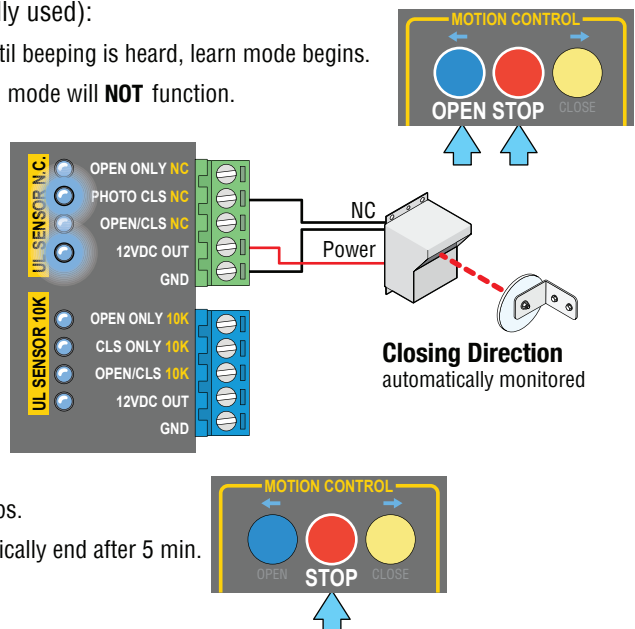

# 11 ADJUST ERD REVERSE SENSOR

The ERD Sensor - Electronic Reversing Device (Type A) **MUST** be adjusted for the **OPEN** and **CLOSE** gate cycles.

When the gate encounters an obstruction during the **CLOSE** cycle, it will reverse to the open position and **PAUSE** the gate. An input command (press remote button or exit loop) is needed **BEFORE** the gate will reset and close again.

When the gate encounters an obstruction during the **OPEN** cycle, it will reverse approximately 6 inches and **PAUSE** the gate. An input command (press remote button or exit loop) is needed **BEFORE** the gate will reset and open again.

For the ERD Sensitivity to function correctly:

- Gate positions must be learned **BEFORE** adjusting the ERD Sensitivity.

**16 sensitivity setting positions in EACH direction.**  
**NO mechanical hard stops for knobs.**

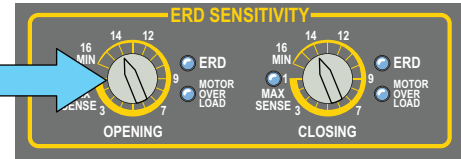

## Typical Settings:

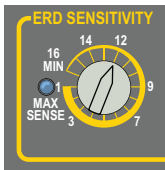

**Position 12:**  
• Typical gate setting.

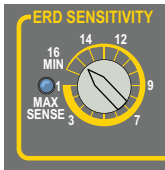

**Position 15:**  
• Heavy gate setting.  
• Long gate setting.

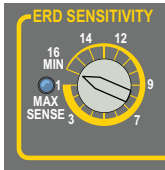

**Position 16:**  
• High wind area gate setting.

**CAUTION:** Position 16 results in gate exerting **MAXIMUM force** before reversing direction.

**TIP: While Adjusting ERD.....**

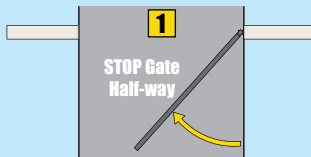

**1**  
**STOP Gate Half-way**  
Position gate half-way open and **STOP** gate. This gate position will put the most amount of resistance on the ERD sensor when gate cycles.

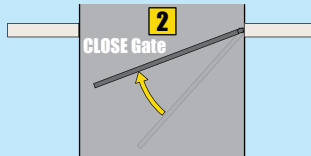

**2**  
**CLOSE Gate**  
**CLOSE** gate. If ERD sensor triggers, reduce sensitivity. If sensor does **NOT** trigger, sensitivity is set correctly.

## Adjust ERD for EACH direction:

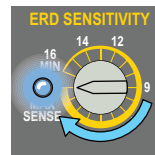

**A.** Turn knob until blue LED lights up. Maximum sensitivity reached, **Position 1** - Too sensitive for most gates.

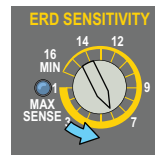

**B.** Turn knob **counter-clockwise** to reduce gate sensitivity while testing ERD until desired results is attained. (LED remains OFF for all but position 1)

If alarm sounds while adjusting ERD, press **STOP BUTTON** to shut-off alarm.

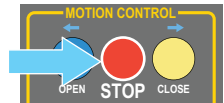

**IMPORTANT:** When satisfied with ERD adjustment, cycle the gate a few times to make sure that the ERD sensor does not **falsely trigger** during normal gate operation. Re-adjust if this happens.

# 12 LOOPS & LOOP DETECTORS

## Loop Detector Rack

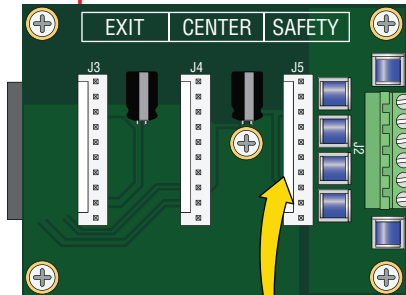

## In-Ground Loops

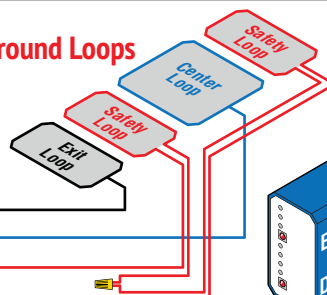

Safety loops wired in series.

## External Loop Detectors

Wire directly to 7-PIN terminal

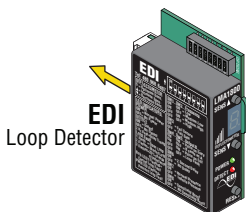
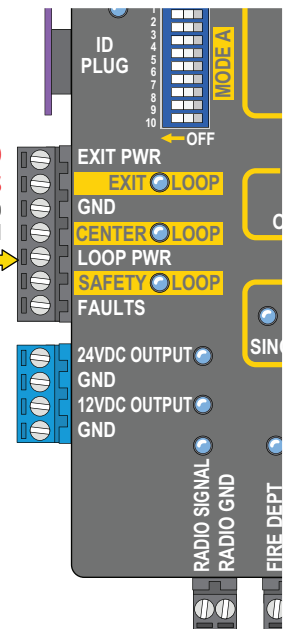

EDI Loop Detector

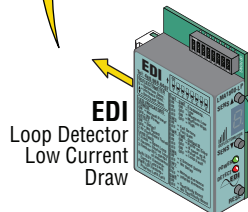

EDI Loop Detector Low Current Draw

## Plug-In Loop Detectors

**NOTE: DO NOT** select the **PULSED** output option for Loop Detectors.

**NOTE: DO NOT** set Loop Detectors to **HIGH** sensitivity to avoid false trigger.

# 13 DSP CONTROLLER BOARD SETTINGS

## Battery Back-Up Mode

**LEAVE OPEN** - After a power failure, gate will continue to operate until battery power is drained. At this point, the next open command, gate will remain **OPEN**. Gate will **automatically** close after AC power is restored if close timer is ON.

**LEAVE CLOSED** - After a power failure, gate will continue to operate until battery power is drained. At this point, gate will remain **CLOSED**.

**OPEN 1 TIME** - After a power failure, gate **automatically OPENS** and **REMAINS OPEN**. When power is restored, gate will **automatically** close.

## Anti-Tailgate

**Turned OFF** - Close timer will close the gate at its selected time.

**Turned ON** - (In-ground loops required) Gate will close after all the in-ground loops have been cleared no matter how long the close timer is set for. When an in-ground **safety** loop gets activated during the close cycle, gate will **PAUSE** and **NOT** reopen. When loop is cleared, gate will continue to close **preventing UNAUTHORIZED** entry.

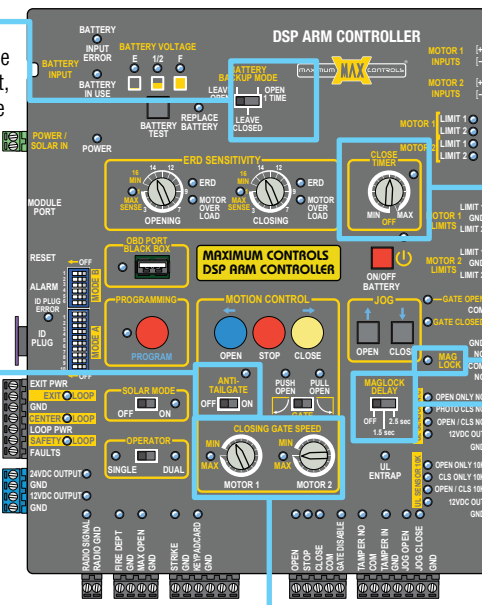

## Close Timer

- 1st click clockwise - Knob at MIN: 1/2 sec...
- 2nd click clockwise: 1 sec...
- 3rd click: 4 sec...
- 4th click: 8 sec... etc up to 60 sec. MAX.

## Maglock Delay Set to OFF

**Turned OFF** - NO Maglock installed.

**Set to 1.5 sec or 2.5 sec** - You **MUST** select a time delay when using a maglock. Maglock power disengages 1.5 sec or 2.5 sec **before** gate starts opening.

**Dual Gate Operators using Maglock:** Primary gate opens **FIRST** so install maglock accordingly.

**MAGLOCK LED (Monitors Maglock):**  
**ON** - Locked  
**OFF** - Unlocked

**Flashing** - Problem with Maglock Power. See below to wire this feature.

## Gate Speed

Typically Set to MAX

# 14 WIRING OPENING DEVICE OPTIONS

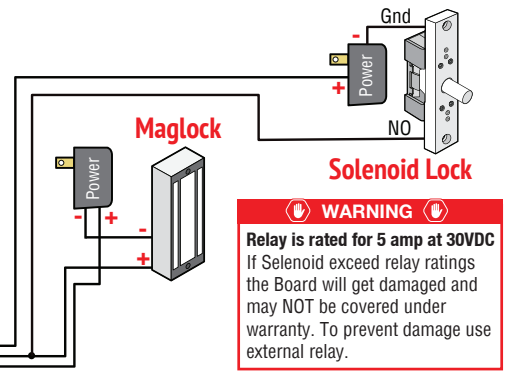
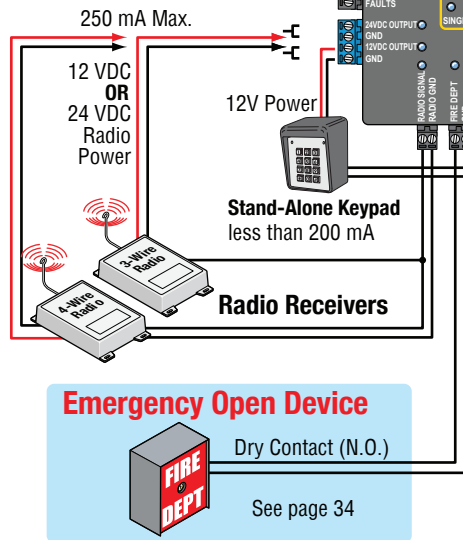
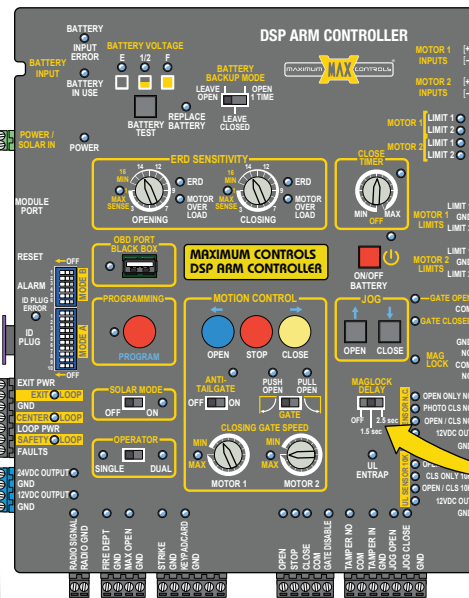

**Bi-parting gates using lock:** Primary gate opens **FIRST**. Install lock accordingly to account for this.

**Maglock Delay MUST** be set for 1.5 sec OR 2.5 sec when installing a lock.

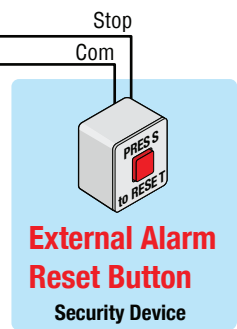
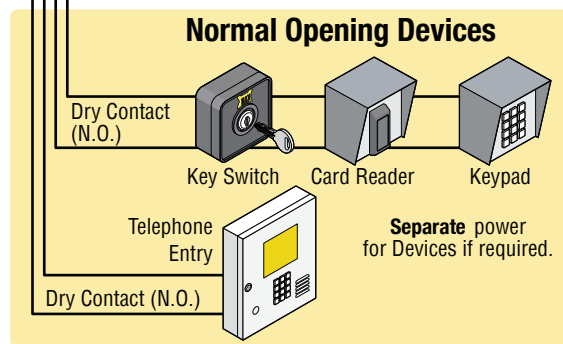

# 15 UL SENSOR LEARN MODE

## AUTOMATICALLY MONITORED UL sensor Input

A sensor wired to the **PHOTO CLS NC** will **"AUTOMATICALLY" be MONITORED** (Factory default).  
**All other inputs MUST be learned** before they will be monitored.

### Sensor Learn Mode:

1. Press and **HOLD** the **STOP** button & then the **OPEN** button together until beeping is heard, learn mode begins. **DO NOT** press the **OPEN** button before the **STOP** button or learn mode will **NOT** begin (no beeping).

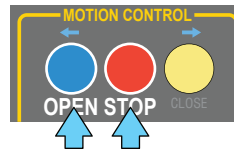

2. LEDs **WILL** turn **ON** for each detected **"LEARNED"** sensor that has been wired to the inputs. If a sensor's LED is **NOT** on, that sensor has a problem and it **MUST** be corrected before continuing.

#### Possible problems:

- Photocells are out of alignment
- Photocells are wired wrong - N.C. or N.O. depending on which type of photocells are used.
- Sensor is bad

When all LEDs are **ON** that should be **ON**, proceed to next step.

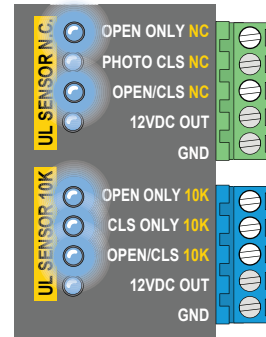

**"Learned"** monitored  
**Automatically** monitored  
**"Learned"** monitored

**"Learned"** monitored  
**"Learned"** monitored  
**"Learned"** monitored

3. Press **STOP** button again within 5 min. to learn sensors and end learn mode, beeping stops. **Wired "Learned" Inputs will now be MONITORED**.

**NOTE:** If **STOP** button is not pressed within 5 min., learn mode terminates. If no **"LEARNED"** sensors are detected then factory default setting is restored (Inputs will **NOT** be Monitored).

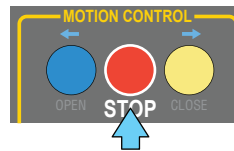

# 16 DIP-SWITCH SETTINGS

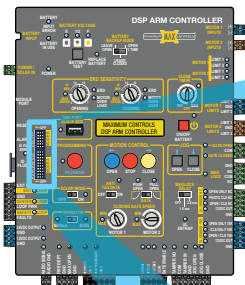

Set desired features using DIP-switches.

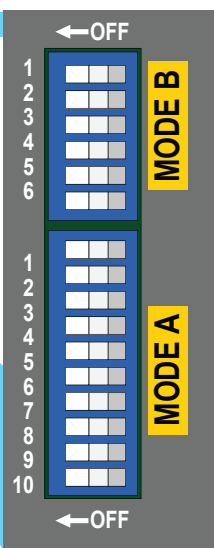

- **MODE B** DIP-switch 6 **MUST** be set to chosen operator type

**MAX SUPER ARM 1300** OFF

**MAX SUPER ARM 2300** ON

MODE B Switches		1	Open Relay Pulsed	OFF	Open Relay ON when gate open
		ON	Open Relay Pulsed when gate open		
	2	Secondary Opposite Direction	OFF	Secondary moves <b>same</b> as primary	
		ON	Secondary moves <b>opposite</b> of primary		
	3	Lock on Close	OFF	Stop at close limit (see page 34)	
		ON	Stop on overload condition after seeing close limit		
	4 & 5	Soft start/ Stop Selection	Short	<b>4 &amp; 5 OFF</b>	
			Medium Short	<b>4 ON 5 OFF</b>	
			Medium Long	<b>4 OFF 5 ON</b>	
			Long	<b>4 &amp; 5 ON</b>	
			Best to keep in shorter setting but if gate motion needs to be smoothen out at the end, try lengthening the setting incrementally.		
	6	Actuator Type	OFF	MAX Super arm 1300, MAX arm, MAX Ultra arm	
			ON	- MAX Super arm 2300	
MODE A Switches		1	Battery Beep Mode	OFF	No beeping when ONLY battery power and gate is in motion.
		ON			Beeping when ONLY battery power and gate is in motion.
	2	Gate in Motion Alert	OFF	No alarm while gate in motion	
		ON	Alarm while gate in motion		
	3	Strobe Light Relay Control	ON	Tamper Relay NO/C Triggered while gate in motion for strobe light control.	
	4	Quick-Close	OFF	No quick-close	
		ON	Quick-close ON		
	5	Close Tamper Detect	OFF	<b>NO</b> close tamper detect	
		ON	Trigger tamper relay ( <b>Alarm for slider ONLY</b> )		
	6	Stop Input Polarity	OFF	Stop Input <b>NO-connect</b> to GND to activate	
		ON	Stop Input <b>NC-disconnect</b> from GND to activate		
	7	Open Relay Polarity	OFF	Open Relay <b>CLOSED</b> when gate is open	
		ON	Open relay <b>OPEN</b> when gate is open		
	8	Solenoid OR Maglock Control Relay	OFF	<b>For Maglock:</b> Control relay will trigger <b>BEFORE</b> closed limit is reached.	
		ON	<b>For Solenoid:</b> Control relay will trigger <b>AFTER</b> closed limit is reached.		
	9	UL Closing Photo ON PHOTO CLS NC Anti-tailgate	OFF	UL Closing Photo anti-tailgate <b>OFF</b>	
		ON	UL Closing Photo anti-tailgate <b>ON</b>		
	10	Reserved	OFF	<b>MUST</b> be OFF	
		ON	<b>DO NOT</b> turn ON		

# DUAL GATE OPERATORS

Turn Dual ON.

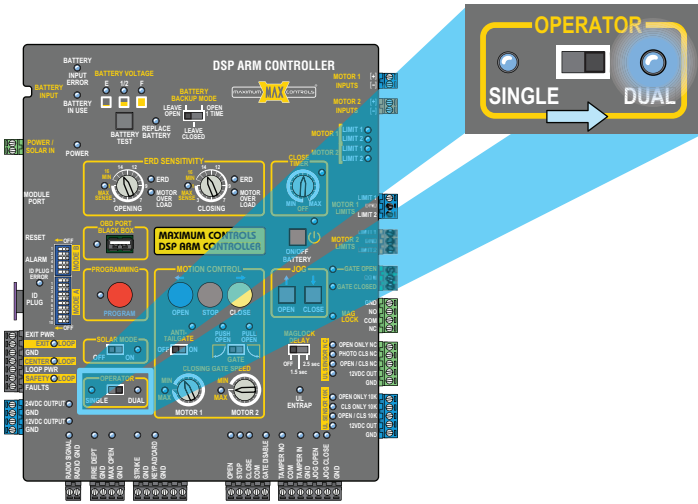

- **OPERATOR** switch **MUST** be set to **DUAL**.
- Jog **OPEN/CLOSE** buttons operate **BOTH** arms together.
- **EACH** arm is **MANUALLY RELEASED** individually.
- **CLOSING GATE SPEED** is adjusted for **EACH** arm.
- **ERD** adjusts **BOTH** arms sensitivity at the same time.
- **MODE B** DIP-switch 6 **MUST** be **OFF**.
- **MOTOR 1** opens **FIRST**. Install gate overlap/maglock accordingly to account for this.

## INSTALLATION NOTES:

**PULL** Open installation shown.

Safety device wiring and in-ground loops **NOT** shown.

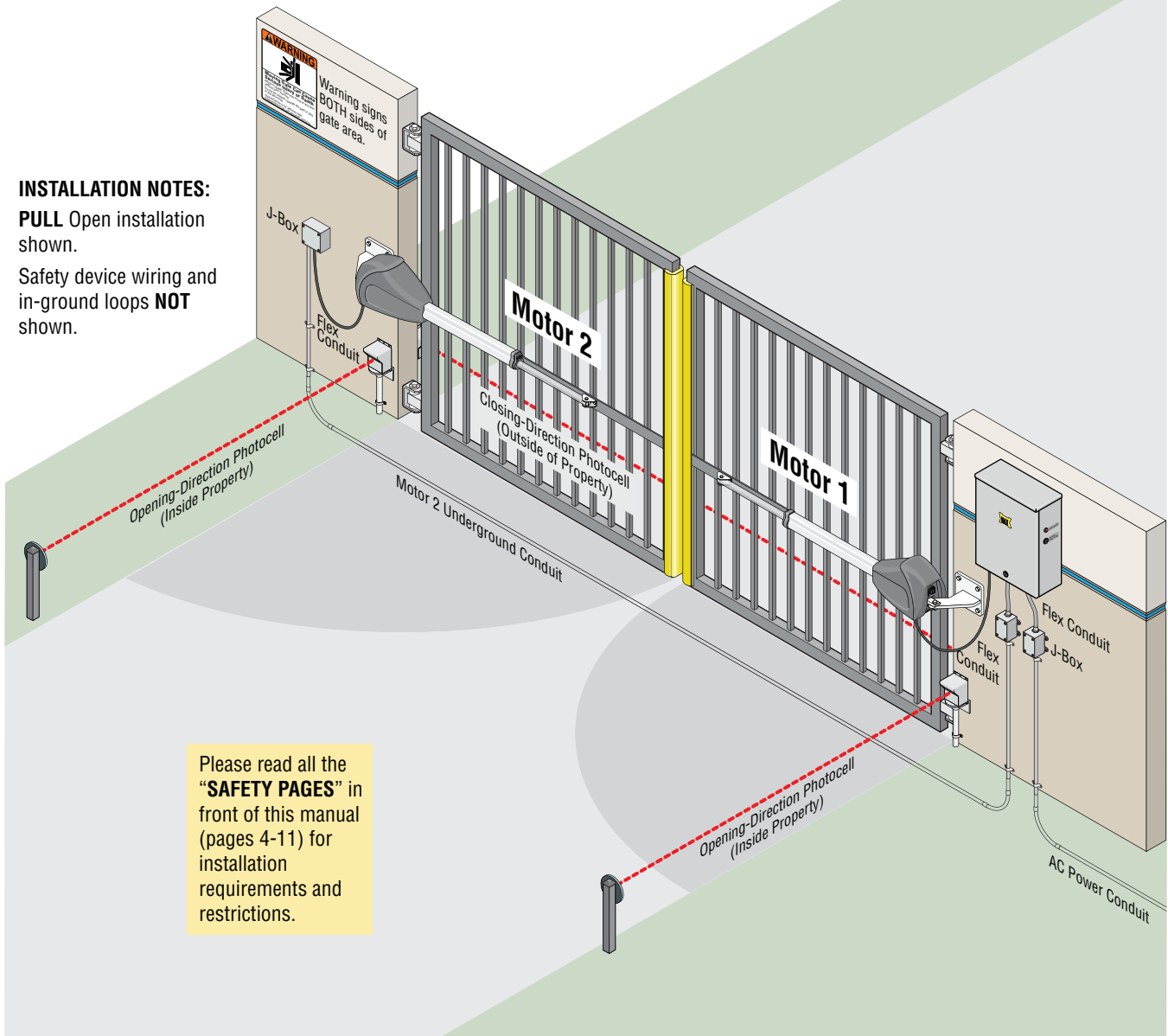

Please read all the "SAFETY PAGES" in front of this manual (pages 4-11) for installation requirements and restrictions.

# ADDITIONAL FEATURES

## MAX OPEN / FIRE DEPT INPUTS

**FIRE DEPT Input:** Should be connected to a Knox box device to allow the proper authorities to gain emergency access when necessary. The input will override the **GATE DISABLE** input and allow **EMERGENCY** personnel **FULL** 24/7 access. Gate fully opens.

**MAX OPEN Input:** Can be connected to a key switch and used as an **ADDITIONAL** input from the FIRE DEPT input. The input will override the **GATE DISABLE** input and allow **SECURITY** personnel **FULL** 24/7 access. Gate fully opens.

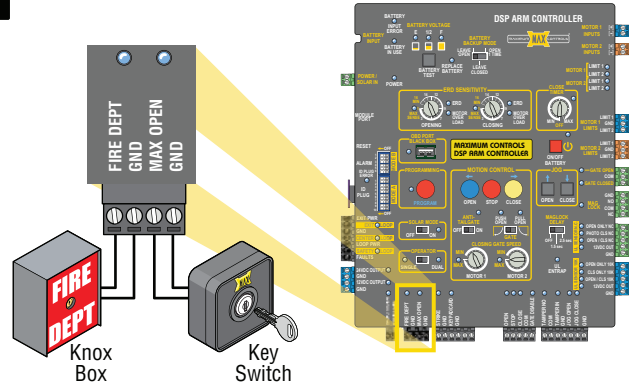

## GATE TAMPER

The **GATE TAMPER** can be used for various functions such as turning a warning light, siren or camera on when the gate is tampered with (Vandalized Gate). The gate operator defines a "Vandalized Gate" as **UNAUTHORIZED** movement of the gate. This can occur if the arm is manually released and gate is moved from the **closed position** (or the gate is forced open from the **closed position without authorization**).

**TAMPER NO/Com Relay:** Connect a warning light, siren, camera or an existing alarm system to relay.

**TAMPER IN/GND Input:** Connect a sensor device to input. When Tamper In/GND gets triggered, device that is wired to Tamper relay (NO/Com) will activate.

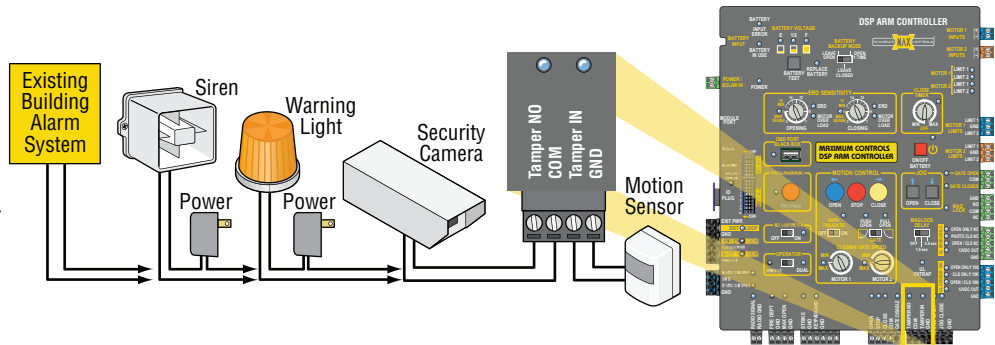

**GATE TAMPER** relay will activate when:

- Arm is **MANUALLY RELEASED** and pushed open from the **closed position without authorization**.
- Gate is **PHYSICALLY** moved from the **closed position** with **EXTREME** force.
- When the **FIRE DEPT** switch is activated **ONLY** if the **GATE DISABLE** has been turned **ON**.

## GATE DISABLE

An ON/OFF switch or 7-Day timer device can be connected to the **GATE DISABLE** input. When these devices are turned ON, they will **DISABLE** normal opening devices such as keypad, exit loop etc. The **FIRE DEPT/ MAX OPEN** and **RADIO** inputs will remain enabled when **GATE DISABLE** has been turned ON. This is useful when the gated area needs to be secured from ALL but emergency or authorized vehicle entry. Some examples are: Residential home vacation period or during closed hours of a business when no one can monitor the property.

**When GATE DISABLE is turned ON:** The operator will beep for **3 minutes BEFORE arming itself**. This allows time to turn ON **GATE DISABLE** and leave the property before it is armed.

**When FIRE DEPT/MAX OPEN gets activated:** Gate opens and **GATE TAMPER** relay will activate immediately.

**When RADIO Input gets activated:** Gate opens and **GATE TAMPER** relay will activate **after 3 min**. This allows time to turn OFF **GATE DISABLE** or disarm an existing building alarm system if connected.

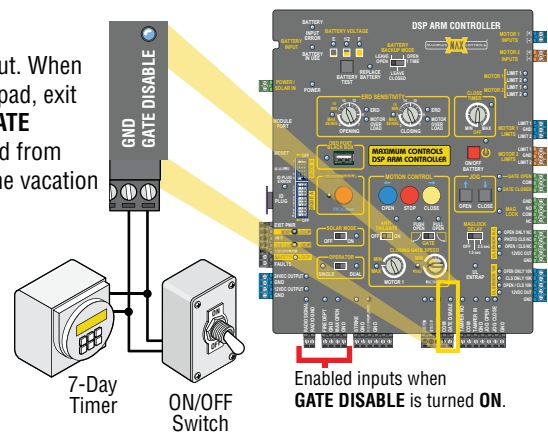

Enabled inputs when **GATE DISABLE** is turned ON.

**GATE DISABLE** prevents:

- Trying to trigger the **EXIT loop** to get the gate to open.
- Breaking into a keypad box and trying to trigger the wires to get the gate to open.

**IMPORTANT:** It is **NOT** recommended activating the **GATE DISABLE** device while persons are present inside the property.

# ADDITIONAL FEATURES

## OPEN / STOP / CLOSE INPUTS

The **OPEN/STOP/CLOSE** inputs will allow a standard 4-wire **3-Button Station** and a **External Alarm RESET Button** to be connected. Corresponding LEDs will light when each button is activated.

### External Alarm Reset Button

An external Alarm Reset button can be installed in a secure place and connected as shown to quickly **SHUT-OFF** a sounding alarm. Otherwise alarm can be shut-off by the **RESET ALARM** button on the side of control box (see below).

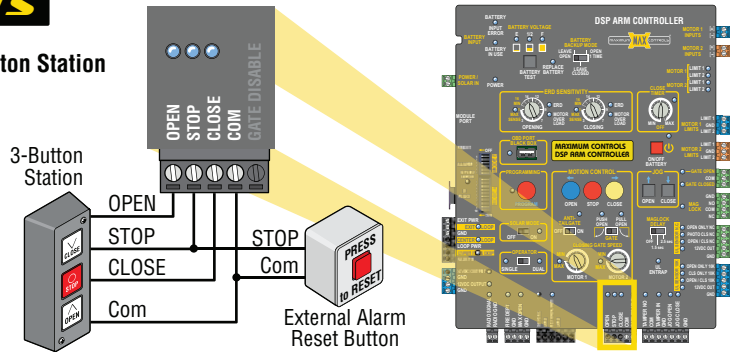

## RESET ALARM BUTTON / JOG GATE OPEN/CLOSE

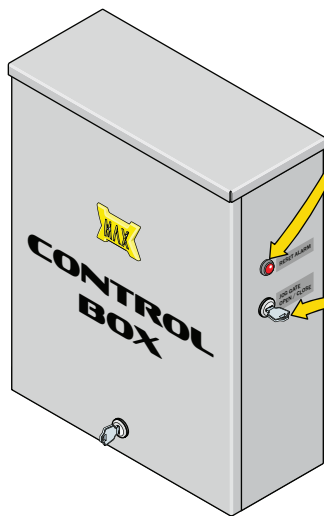

### Reset Alarm Button:

**If the Alarm Sounds During Normal Gate Operation:** When the gate encounters **TWO** consecutive obstructions before completing a gate cycle, the alarm will sound and the gate will **PAUSE** in the position where the second obstruction occurred.

**CHECK THE GATE AREA FOR ANY PROBLEMS BEFORE** pressing the alarm reset button on the control box to shut off the alarm and reset the gate.

**NOTE:** Alarm will automatically shut-off after five minutes but **will not allow** gate to operate until the **alarm reset button** is pressed.

### Jog Gate Open/Close:

The **JOG** key switch can open or close the gate electronically. Insert key on control box, turn and **HOLD** (in either direction) to **MOVE** gate. Jog switch will operate **BOTH** arms together for bi-parting gates. **NOTE: OWNER** of the gate operator is responsible for the **KEY** availability.

**JOG** buttons on circuit board function the same as **JOG** key switch.

**CAUTION:** Keep pedestrians and vehicles clear of the gate while it is moving.

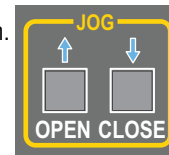

## PROGRAMMING

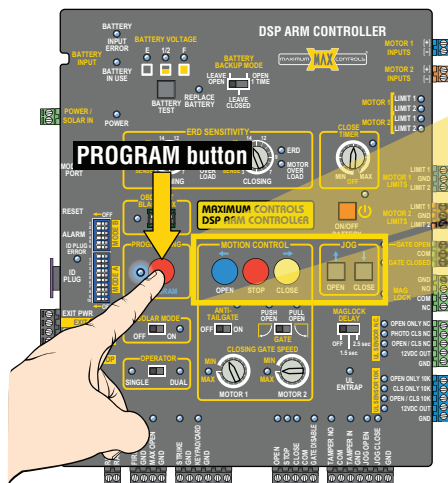

Press and hold **PROGRAM** button for 5 seconds to enter program mode.

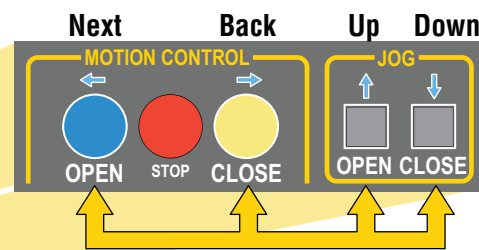

### Programming Assistant Buttons

To enter **PROGRAM** mode, **press and hold PROGRAM** button for 5 seconds. Follow instructions on-screen using the 4 buttons shown above to program with. Press **ONLY PROGRAM** button again to end programming when finished.

In **PROGRAM** mode, you can do the following:

- Scroll through most recent errors.
- View input voltage (DC voltage).
- View average current gate consumption.
- View cycle count.
- Program date and time.
- Turn on/off other advanced features.

# ADDITIONAL FEATURES

## LOCK TO CLOSE

Mode B DIP-Switch 3 **MUST** be **ON**. Securely locks a **SINGLE** gate OR **DUAL** gates to a positive stop **without** the need of a maglock. Gate(s) **MUST** have a **POSITIVE STOP** installed in order for this feature to work.

### Single Gate

Gate must have a **positive stop** in closed position (such as a trim piece on a gate post that overlaps gate). Mode B DIP-Switch 3 **MUST** be **ON**.

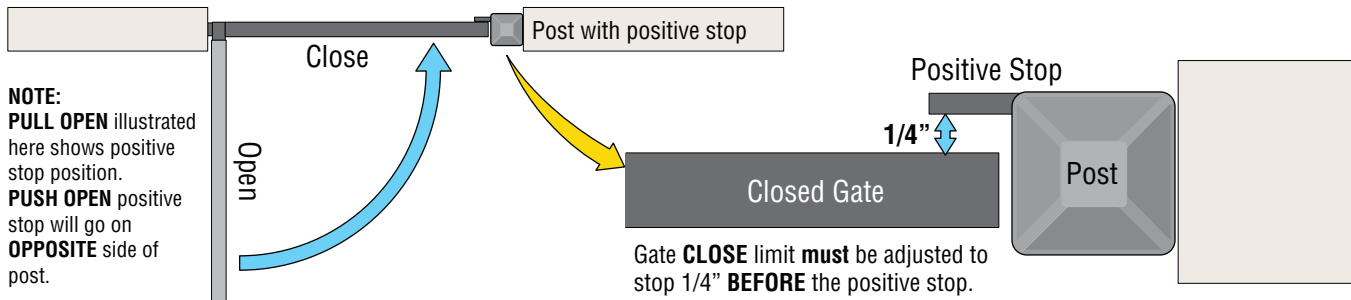

When gate closes **AFTER** limits have been learned, gate will close to close limit position and **continue very slowly until it touches the positive stop** ...“actively” locking gate against the positive stop. This securely locks the gate to positive stop **without** the need of a maglock. The gate **will not** have any play in **CLOSED** position...it is locked in place.

### Dual Gates

**Secondary** gate must have a **positive stop** (such as a trim piece on the **SECONDARY** gate that overlaps primary gate). Secondary gate reaches close position **FIRST**.

Mode B DIP-Switch 3 **MUST** be **ON**.

The **MAGLOCK DELAY** must be set to **1.5 sec** so the gates **do not** collide due to the positive stop overlap plate.

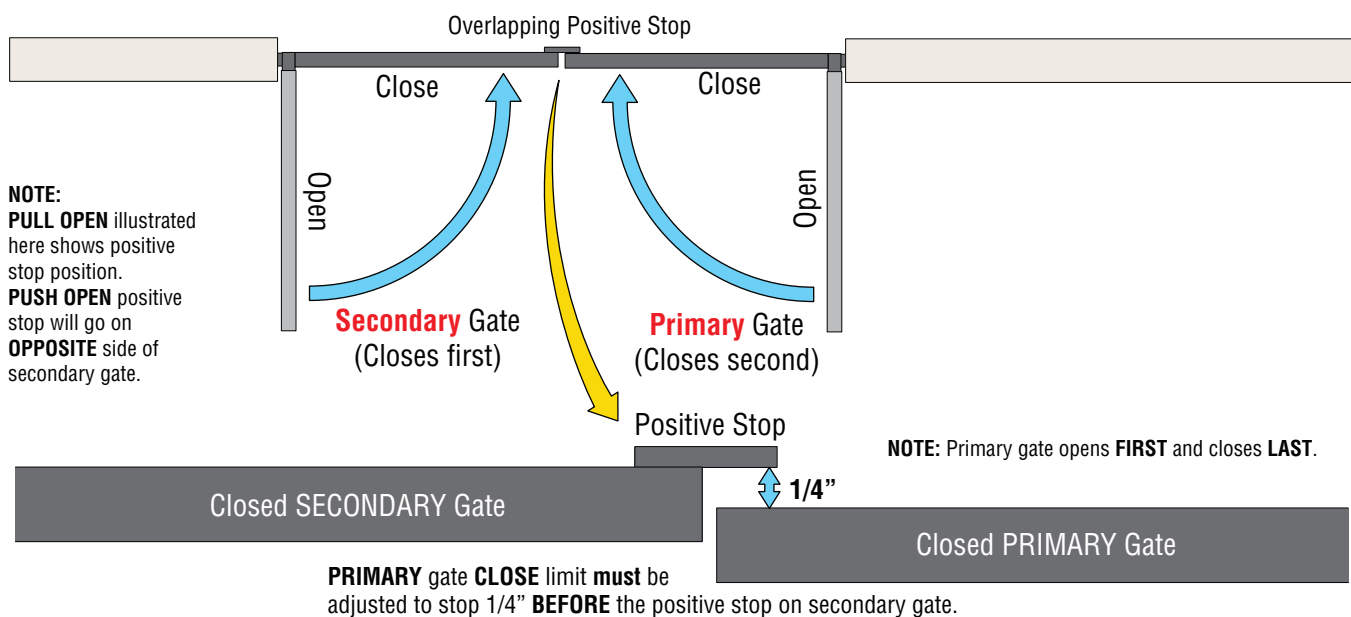

When gates close **AFTER** limits have been reached, **SECONDARY** gate will reach close position **FIRST** (**MAGLOCK DELAY** must be set to **1.5 sec**). **PRIMARY** gate then will close to close limit position and **continue very slowly until it touches the positive stop on secondary gate** ...“actively” locking **PRIMARY** gate against the positive stop on secondary gate. This securely locks the gates together **without** the need of a maglock. The gates **will not** have any play in **CLOSED** position...they are locked in place.

# ADDITIONAL FEATURES

## MAX CELL HUB

No need for conventional large control box to manage access areas. Manage gate access areas using **Max Cloud App**: for card readers, radio receivers or transponders)

- Works exclusively on Max operators (Max PRO series / Actuators)
- Affordable cell data plans (AT&T or Verizon)
- Use the **Max Cloud App** to manage access areas (**Up to 16** different areas per cell hub).
- Max Cell Hub plugs into “**Module Port**” of DSP Arm controller board.
- Cell hub communicates with **Max wiegand converter** device or **Max keypad** device **hardwired** or **wirelessly**.
- Supports RS485 peripheral devices.
- Works when battery back-up power only is being used by DSP Arm Controller board.

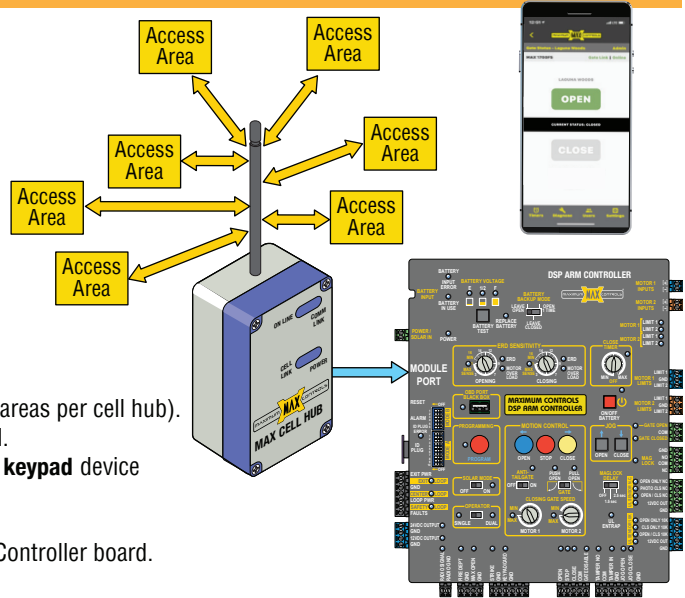

## MAX WIEGAND CONVERTER

- Works in conjunction with the Max Cell Hub, **hardwired** or **wirelessly** connected.
- Control an access area with a dedicated relay in the wiegand converter device.
- Wiegand port supports any 26-bit keypad, card reader, radio receiver & RFID transponder.
- Use the **Max Cloud App** to program cards/keyfob, radio transmitters & transponder tags and assign optional time restrictions.
- Wiegand converter supports exit switch request for pedestrian gates.
- Track the wiegand device's activity in the event log from the black box on DSP board.

Connect any **ONE** of these options to the Max wiegand converter device.

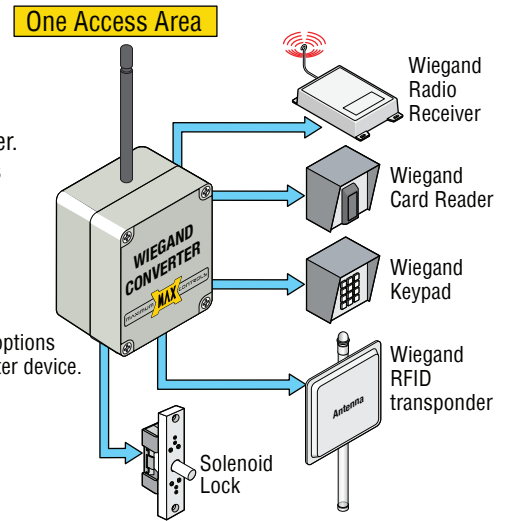

## MAX KEYPAD

AVAILABLE WITH CELL DATA ACTIVATION

- Works in conjunction with the Max Cell Hub, **hardwired** or **wirelessly** connected.
- Wiegand input port supports any 26-bit card reader, radio receiver & RFID transponder.
- Use the **Max Cloud App** to program cards/keyfob, radio transmitters & transponder tags and assign optional time restrictions.
- Programmable keycodes via **Max Cloud App**.
- Request to exit (RTE) Port.
- Track the keypad device's activity in the event log from the black box on DSP board.

Connect any **ONE** of these options to the Max keypad device.

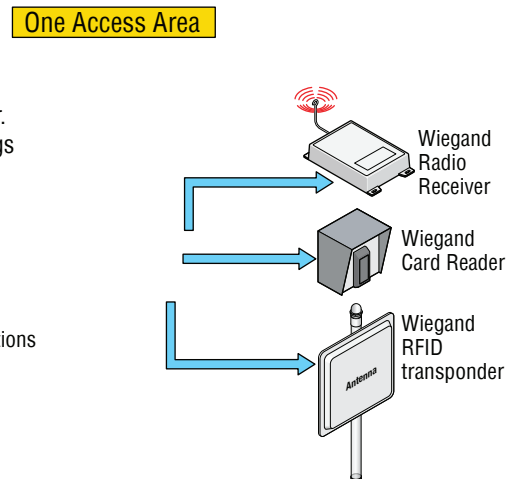

# SOLAR CONTROL BOX INSTALLATION

Steel housing  
Two layers protection  
Gold zinc  
Electrostatic  
Powder-Coating

**SOLAR MODE**  
Switch to enable  
low power draw  
for solar mode

Gold plated  
automobile connectors  
through-out the system

Loop Rack  
**OPTIONAL**

Control Panel

Two 12V 18 AH  
(AGM Rechargeable Batteries)

UL Reset Button

Jog Switch  
**OPTIONAL**

Solar Regulator  
24V, 10A  
(Morning Star)

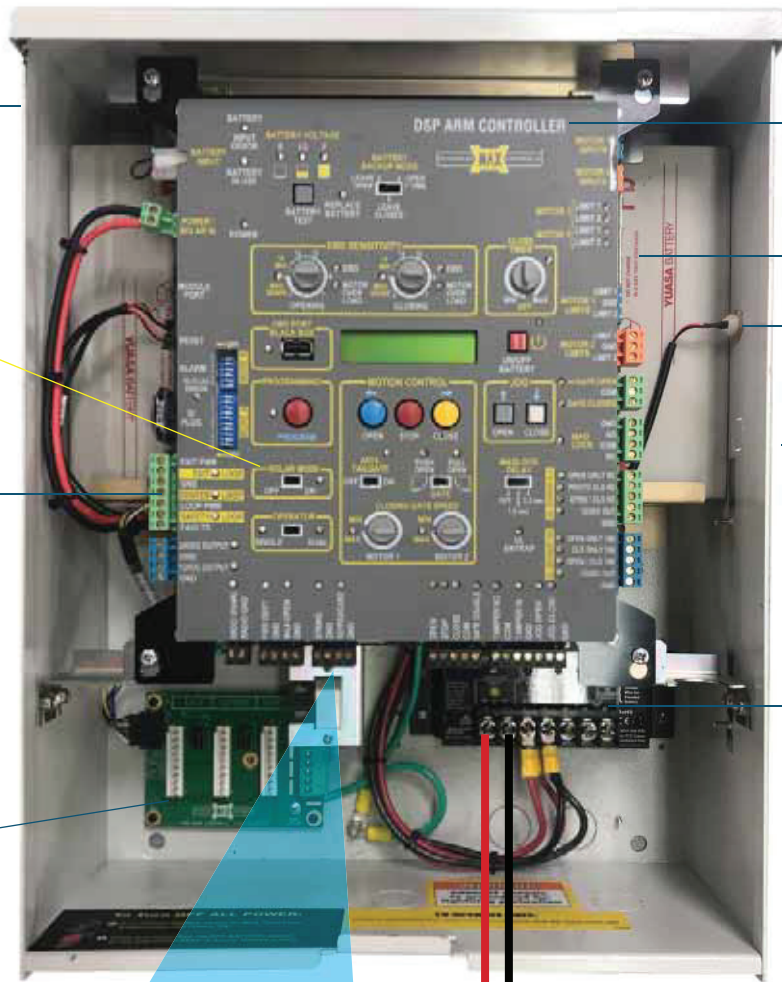

**1**

Insert the included  
fuse into the empty  
fuse slot (no polarity)

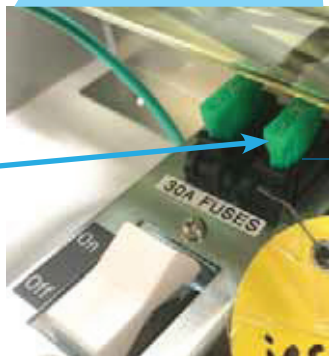

30A  
FUSE

**2** V(+) GND Wire solar panel terminals to  
solar regulator input  
Caution: polarity matters

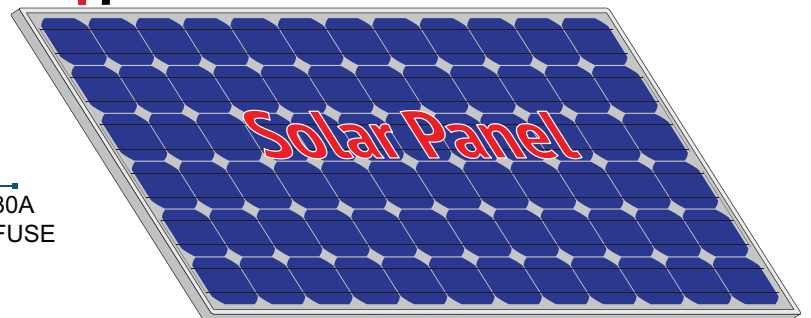

24V Solar Panel  
Output: 36V (max) -  
Open Circuit

**3**

Turned ON the switch located directly  
underneath the fuses



**4**

Leave the solar mode switch off and follow the included installation manual for  
standard installation and setup of limit switches

**DO NOT TURN ON THE SOLAR MODE SWITCH UNTIL INSTALLATION IS FINISHED**

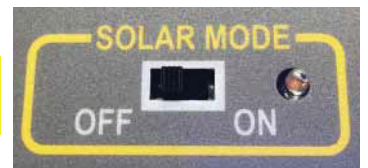

# SOLAR CONTROL BOX INSTALLATION

## 5 Turn SOLAR MODE ON

Operator will go into low power mode 30 seconds after gate stops moving and loop detectors are not active. While in low power mode:

- All LEDs will turn off except power LED and solar mode LED (blinking)
- 12V DC OUTPUT and 12V DC OUT on 10K port will remain ON, all other power outputs will turn OFF
- **EXIT LOOP** detector remains **ON**, **CENTER & SAFETY LOOP** detectors are turned **OFF**.

Turn SOLAR MODE ON.

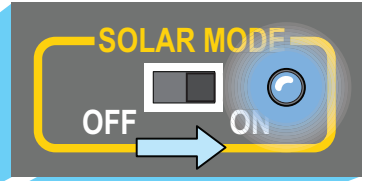

Power radio receiver using **12V DC OUTPUT**  
In low power mode, **12V DC OUTPUT** is left ON

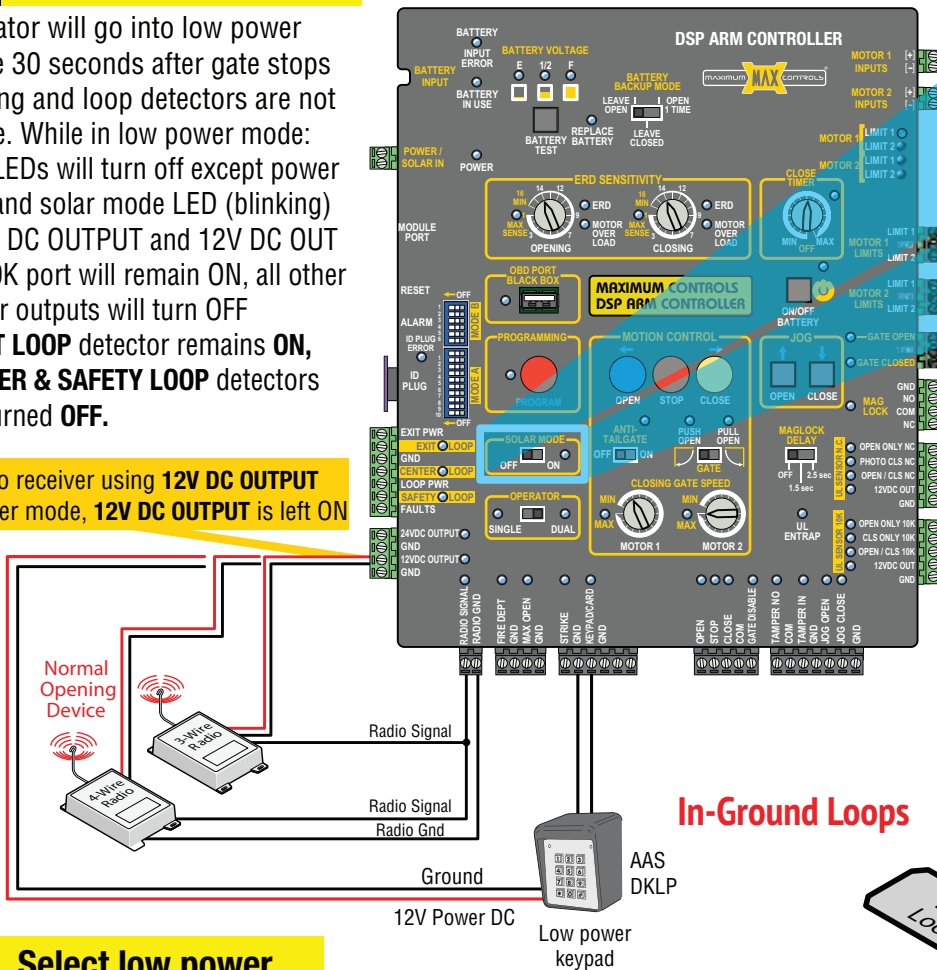

In-Ground Loops

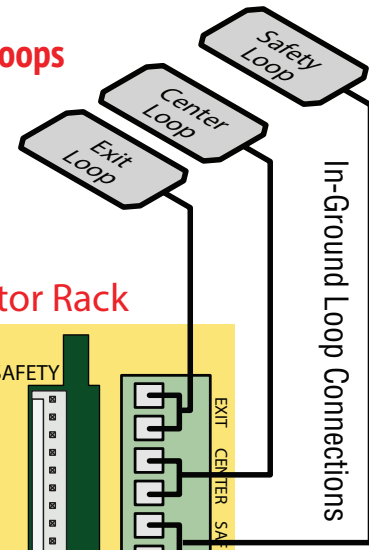

## 6 Select low power radio RECEIVER

For OPTIONAL Loop Rack

## 7 Select Low Power Loop Detectors

Recommended: Plug-In Loop Detectors  
EDI LMA1800-LP

**NOTE:** While in low power mode, **EXIT LOOP** detector remains **ON**, **CENTER & SAFETY LOOP** detectors are turned **OFF**

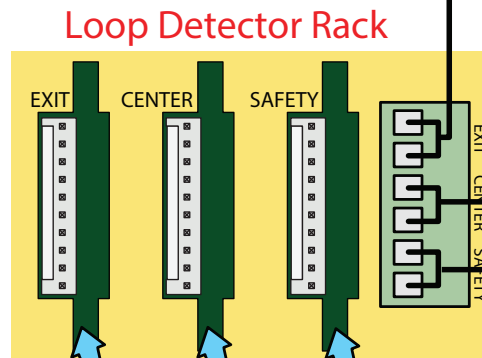

## 8 OPTIONAL

Remove local 7A/Hr batteries from operator and **TURN ON** DIP Switch MODE A -1

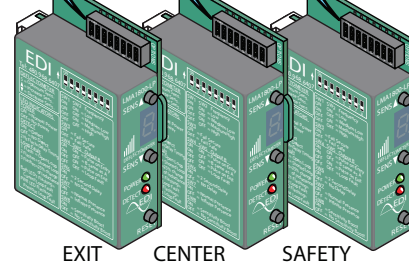

# SOLAR CONTROL BOX INSTALLATION

## Select proper solar panel

### SWING, ACTUATOR

ACTUATOR		GATE SOLAR CYCLES PER DAY with built-in 18A/Hr battery					
PANEL SIZE	Total System Current Draw (mA)	ZONE 1 (6 Hrs Sunlight/Day)		ZONE 2 (4 Hrs Sunlight/Day)		ZONE 3 (2 Hrs Sunlight/Day)	
		Cycles/day w/1 rainy day	Cycles/day w/10 rainy days	Cycles/day w/1 rainy day	Cycles/day w/10 rainy days	Cycles/day w/1 rainy day	Cycles/day w/10 rainy days
60 W	26	1328	346	1233	252	1138	157
	50	1295	314	1197	215	1098	117
	100	1227	245	1121	139	1015	33
	200	1091	109	970		848	
	250	1023	41	894		765	
85 W	26	1442	460	1309	327	1176	195
	50	1409	427	1273	291	1136	155
	100	1341	359	1197	215	1053	71
	200	1205	223	1045	64	886	
	250	1136	155	970		803	
120 W	26	1601	619	1415	433	1229	248
	50	1568	586	1379	397	1189	208
	100	1500	518	1303	321	1106	124
	200	1364	382	1152	170	939	
	250	1295	314	1076	94	856	
200 W	26	1965	983	1658	676	1351	369
	50	1932	950	1621	639	1311	329
	100	1864	882	1545	564	1227	245
	200	1727	745	1394	412	1061	79
	250	1659	677	1318	336	977	

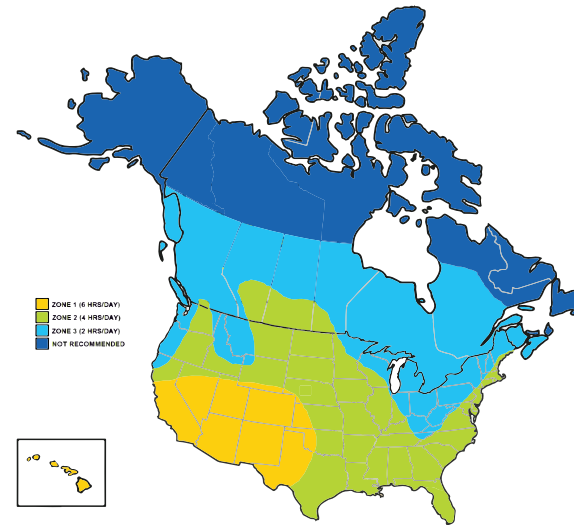

The map and daily cycle rate shown are approximations based upon the average solar radiation and the temperature effects on batteries in the given regions. Local geography and weather conditions may require additional solar panels.

**USE LOW POWER accessories in order to minimize power draw. Each additional accessory draws power affecting the daily cycle rate.**

Rev. 09/23/19

# TROUBLESHOOTING

These next pages can help troubleshoot problems that might occur after installation is complete.

## OBD PORT BLACK BOX

Download a simple .txt file to troubleshoot gate operator errors and view event history.

1. Plug MAX USB flash drive into **OBD port**. OBD LED will flash while file is downloading. Remove flash drive after LED stops flashing (up to 5 minutes to download).
2. Plug flash drive into any computer USB port **OR** smart phone using a USB phone adapter. The most recent **8000 events can be viewed**. No special software required.

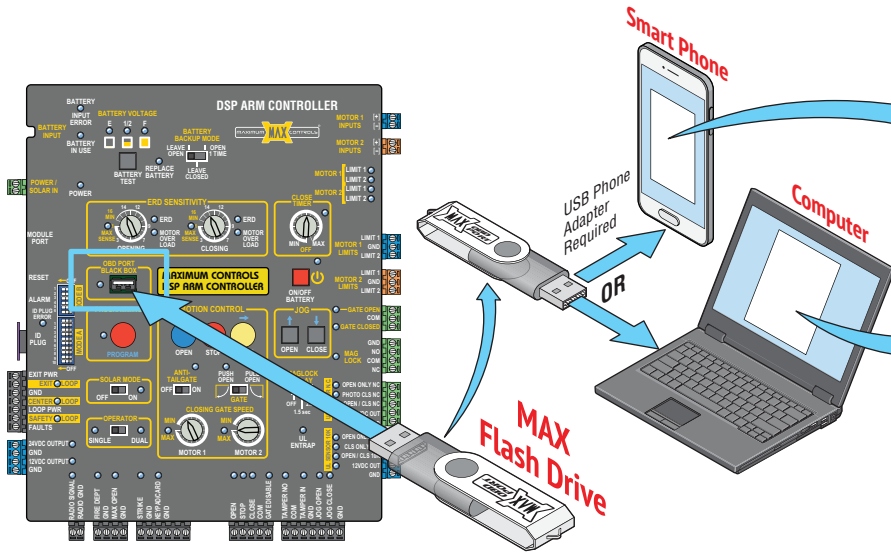

### Event History Text Document Sample

Event type clarification:  
**INFO:** informational message only  
**WARNING:** unusual event but doesn't cause system malfunction  
**ERROR:** abnormal event, could cause system malfunction  
**ENTRAP:** entrapment detection event

Event Report:	Event Description
07/11/2021 10:59:41	INFO : Cycle Counter
Fri 07/11/2021 10:59:41	<b>ENTRAP : SEC_MC: First ERD Detected</b>
Fri 07/11/2021 10:59:37	INFO : Radio Input Deactivated
Fri 07/11/2021 10:59:36	INFO : Radio Input Activated
Fri 07/11/2021 10:58:54	INFO : PRI_MC: Fully Open Position Learned
Fri 07/11/2021 10:58:53	INFO : SEC_MC: Fully Open Position Learned
Fri 07/11/2021 10:57:40	INFO : PRI_CIO: Communication Established
Fri 07/11/2021 10:57:38	<b>ENTRAP : PRI_MC: Photo Cell Deactivated</b>
Fri 07/11/2021 10:57:34	<b>ENTRAP : PRI_MC: Photo Cell Activated</b>
Fri 07/11/2021 10:57:21	INFO : Radio Input Deactivated
Fri 07/11/2021 10:57:21	INFO : Radio Input Activated
Fri 07/11/2021 10:56:46	<b>WARNING: PRI_MC: Tamper Reported</b>
Fri 07/11/2021 10:56:36	INFO : SEC_MC: Fully Open Position Unknown
Fri 07/11/2021 10:56:36	INFO : PRI_MC: Fully Open Position Unknown
Fri 07/11/2021 10:56:36	<b>WARNING: PRI_MC: Tamper Reported</b>
Fri 07/11/2021 10:56:33	ENTRAP : PRI_MC: Photo Cell Deactivated
Fri 07/11/2021 10:56:33	ENTRAP : PRI_MC: Photo Cell Activated
Fri 07/11/2021 10:56:33	ENTRAP : PRI_MC: Photo Cell Deactivated
Fri 07/11/2021 10:56:33	ENTRAP : PRI_MC: Photo Cell Activated

## TEST PHOTO CLS NC SENSOR

Troubleshoot **PHOTO CLS NC** entrapment protection sensor (Photocell typically used):

1. Press and **HOLD** the **STOP** button & then the **OPEN** button together until beeping is heard, learn mode begins.

**NOTE: DO NOT** press the **OPEN** button before the **STOP** button or learn mode will **NOT** function.

2. **PHOTO CLS NC** LED should be **ON** if an entrapment sensor is detected. If **PHOTO CLS NC** LED is **NOT** on, sensor has a problem.

#### Possible problems:

- Photocells are out of alignment
- Photocells are wired wrong - N.C. or N.O. depending on which type of photocells are used
- Sensor is bad

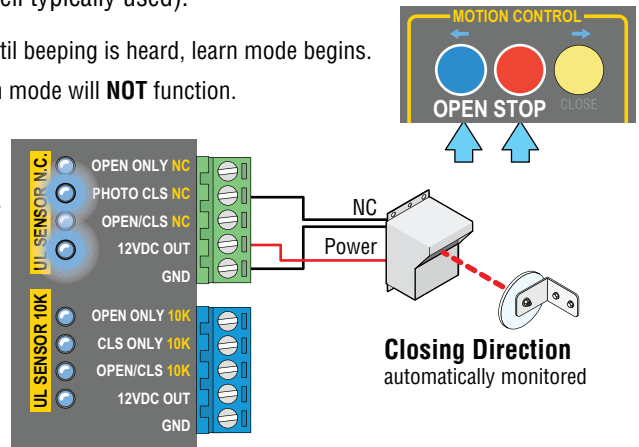

3. Press **STOP** button again within 5 min. to end learn mode, beeping stops.

**NOTE:** If **STOP** button is not pressed within 5 min. learn mode automatically end after 5 min.

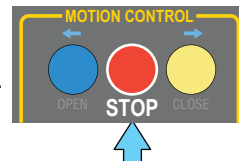

# GATE CYCLING TROUBLESHOOTING

Gate Symptom	Solutions (what to check)
Gate moves slowly.	<ul style="list-style-type: none"> <li>• Check if GATE SPEED rotary dial is set to MAX position (LED on).</li> <li>• Gate may be too heavy for operator (check manual for maximum gate weight for your model operator).</li> <li>• Check if "BATTERY IN USE" LED is ON. If so, gate is on Battery back-up mode and battery is running low.</li> <li>• Gate hinges may be too tight.</li> </ul>
Gate beeps when opening and closing. Gate does NOT open.	<ul style="list-style-type: none"> <li>• Operator may be in battery back up mode. check if "Mode A" switches are set correctly.</li> <li>• Check if "Gate in Motion" Alarm feature is ON ("Mode A" switch 2 is set correctly).</li> <li>• Check if Power LEDs are ON on both DSP board and Toroid box.</li> <li>• Check if GATE "PULL open / PUSH open" switch is set properly.</li> <li>• Check if GATE DISABLE LED is ON. If so, check if GATE DISABLE input is active.</li> <li>• Check if "OPEN ONLY 10K/NC" LED or "OPEN/CLS" LED is ON or BLINKING. If so, check entrapment sensor wiring.</li> <li>• Check if "BATTERY IN USE" LED is ON. IF so, battery may be too low and gate is kept closed (BATTERY BACK-UP MODE switch set to "Leave Closed").</li> </ul>
Gate does NOT close.	<ul style="list-style-type: none"> <li>• Check if Power LEDs are ON on both DSP board and Toroid box.</li> <li>• Check if "PHOTO CLS" LED is ON. If so, check entrapment sensor wiring and alignment.</li> <li>• Check if any loops are active, check SAFETY LOOP, CENTER LOOP or EXIT LOOP LED is ON.</li> <li>• Check if any open command inputs are active (check if LED is ON for: RADIO, FIRE DEPT, MAX OPEN, STRIKE, KEYPAD/RDR. Check device connected to the input that LED light is turned ON.</li> <li>• Check if GATE "PULL open / PUSH open" switch is set properly.</li> <li>• If "OPEN ONLY 10K/NC" LED or "OPEN/CLS" LED is ON. If so, check entrapment sensor wiring.</li> <li>• If "BATTERY IN USE" LED is ON and BATTERY BACK-UP MODE switch is set to "leave Open", then battery may be too low and gate is kept OPEN.</li> <li>• If "BATTERY IN USE" LED is ON and BATTERY BACK-UP MODE switch is set to "OPEN 1-TIME", then if AC power is lost, gate will automatically open 1 time.</li> <li>• If "CLOSE TIMER" is OFF, then gate will not close automatically. A close command (radio, close) is required to close gate.</li> <li>• Loop detector is defective (CENTER, EXIT, or SAFETY). All 3 loop LEDs flashing indicates loop fault.</li> <li>• Loop has a short or open. Measure loop resistance.</li> <li>• Check if manual release on arm is released. If so, re-lock manual release.</li> </ul>
Gate stops prematurely and beeps, moves in opposite direction. Gate will stop before reaching desired limit setting.	<ul style="list-style-type: none"> <li>• If "ERD" LED is ON, an obstruction (ERD event) is detected. If no apparent obstruction, select a less sensitive ERD setting.</li> <li>• If ANY UL sensor LED is ON, entrapment sensor is triggered.</li> <li>• Gate Open and Close Limits have not been learned properly. Relearn limit positions by clearing limits first, press STOP + CLOSE button together for 5 sec (until BEEP is heard), adjust limits and relearn NEW limits.</li> </ul>
Gate stops abruptly while in motion.	<ul style="list-style-type: none"> <li>• Bad hinge - hinge pin offsets during motion causing abrupt gate movement.</li> <li>• Operator placement is not proper or arm pivot point is not correct.</li> <li>• Check if "OPEN/CLS" LED is ON. If so, check entrapment sensor wiring.</li> <li>• Motor cable may be compromised. Unplug cable from "Motor Inputs" and ensure wires are not broken and are crimped properly.</li> </ul>
Gate re-opens while closing. Gate does not learn new limit positions.	<ul style="list-style-type: none"> <li>• Check if closing photocell is misaligned with reflector (check photocell on "PHOTO CLS", "OPEN/CLS" or "OPEN ONLY" inputs.</li> <li>• Use jog OPEN/CLOSE buttons to learn new positions instead of using OPEN or CLOSE buttons.</li> </ul>
Unable to learn limits.	<ul style="list-style-type: none"> <li>• Check label to see that OPEN/CLOSE limit wiring connections are correct.</li> <li>• Ensure to go into learn mode: Hold STOP + CLOSE buttons until BEEP is heard, relearn limits by using OPEN and CLOSE buttons.</li> </ul>
Gate NOT moving after learning limits.	<ul style="list-style-type: none"> <li>• Ensure manual release is re-engaged.</li> </ul>

# DSP BOARD LED TROUBLESHOOTING

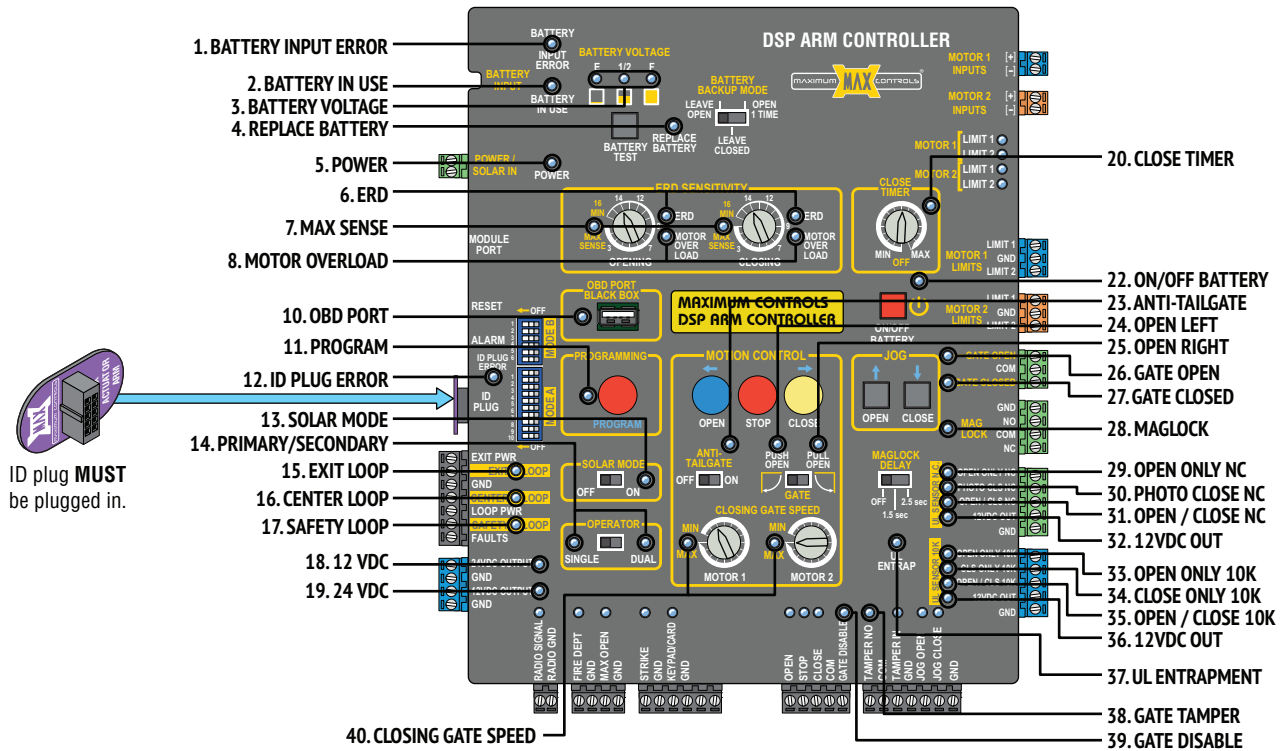

DSP Board LED Problem Condition	Normal LED	Solution(s) for Problem Condition
"BATTERY IN ERROR" LED is ON.	1	• "BATTERY Plug" not plugged in to "BATTERY INPUT" port.
"BATTERY IN USE" LED is ON	OFF	• AC power is lost, operator is in battery back-up mode.
"BATTERY VOLTAGE (E 1/2 F)" LEDs, only "E" is ON.	2	• Check if Toroid box AC POWER ON/OFF SWITCH is ON.
"REPLACE BATTERY" LED is ON.	OFF	• Battery is very LOW. Check if toroid box AC power ON/OFF switch is ON. If so, check AC power.
"BATTERY IN USE" and "POWER" LED are FLASHING	4	• Battery needs to be replaced if BATTERY TEST fails and "REPLACE BATTERY" LED is ON.
"UL Entrap" LED is ON	ON / OFF	• Battery not plugged in to BATTERY INPUT port.
"ERD" LED is FLASHING	37	• An entrapment event has occurred, check if an entrapment sensor was triggered (see if PHOTO CLS, OPEN ONLY, or OPEN/CLS LEDs are on).
"PHOTO CLS" LED is ON	ON	• An ERD event may have occurred. Check for gate obstruction.
"CLS ONLY 10k" LED is ON	6	• ERD sensitivity is too high for application. Re-adjust ERD setting, (see 11).
"PHOTO CLS" LED is flashing	OFF	• Sensor on PHOTO CLS or CLS ONLY 10k inputs (photocell or edge) may have detected an obstruction while closing gate.
"CLS ONLY 10k" LED is flashing	30 / 34	• Photocell on PHOTO CLS or CLS ONLY 10k inputs is misaligned with reflector.
"OPEN ONLY" LED is ON	OFF	• Sensor on PHOTO CLS or CLS ONLY 10k inputs (photocell or edge) may not be wired properly, (see 10).
"OPEN ONLY" LED is FLASHING	29 / 33	• Sensor is NOT a N.C. monitored sensor that is UL 325 2018 compliant.
"MAX SENSE" LED is ON	OFF	• Sensor might need to be re-learned, (see 15).
"OBD PORT" LED is FLASHING	7	• Sensor is damaged or malfunctioning.
"PROGRAM" LED is FLASHING	10	• Sensor on OPEN ONLY input (photocell or edge) may have detected an obstruction while cycling gate.
	11	• Photocell on OPEN ONLY input is misaligned with reflector.
		• Sensor on OPEN ONLY input (photocell or edge) may not be wired properly, (see 10).
		• Sensor is NOT a N.C. monitored sensor that is UL 325 2018 compliant.
		• Sensor on OPEN ONLY is damaged or malfunctioning.
		• Sensor might need to be re-learned, (see 15).
		• MOST sensitive setting for ERD entrapment detection. Select a less sensitive setting (recommend level 10 thru 16), (see 11).
		• Up to 8000 event history and error codes are being downloaded to connected flash drive. Up to 5 min.
		• Program button has been pressed and programming mode is active. Press button again to leave programming mode.

Table continued on next page

# TROUBLESHOOTING CONTINUED

DSP Board LED Problem Condition	Normal LED	Solution(s) for Problem Condition
"ID PLUG" LED is FLASHING and board beeping	OFF <b>12</b>	<ul style="list-style-type: none"> <li>Insert ID PLUG module that is tethered to chassis into "ID PLUG" connector.</li> </ul>
"SOLAR MODE" LED is ON	OFF <b>13</b>	<ul style="list-style-type: none"> <li>Operator is being powered by solar panel ONLY.</li> </ul>
"OPEN/CLS" LED is ON	OFF <b>31</b>	<ul style="list-style-type: none"> <li>Sensor on OPEN/CLS input (photocell or edge) may have detected an obstruction while opening or closing gate.</li> </ul>
"OPEN/CLS" LED is FLASHING	OFF <b>31</b>	<ul style="list-style-type: none"> <li>Photocell on OPEN/CLS input is misaligned with reflector.</li> <li>Sensor on OPEN/CLS input (photocell or edge) may not be wired properly, (see <b>10</b>).</li> <li>Sensor is NOT a N.C. monitored sensor that is UL 325 2018 compliant.</li> <li>Sensor on OPEN/CLS is damaged or malfunctioning.</li> <li>Sensor might need to be re-learned, (see <b>15</b>).</li> </ul>
"MOTOR OVERLOAD" LED is ON	OFF <b>8</b>	<ul style="list-style-type: none"> <li>Check if gate is binding against catch post or bracket in opened or closed position.</li> <li>Check if gate moves manually with low resistance throughout its full range of motion.</li> <li>Check if hinges are operational and well greased.</li> <li>Check if operator is positioned properly relative to the gate hinge, (see <b>1</b>).</li> <li>Gate may be too heavy for operator (check manual for maximum gate weight for your model operator).</li> </ul>
"EXIT" LOOP LED is FLASHING or constantly ON	OFF <b>15</b>	<ul style="list-style-type: none"> <li>Loop fault condition: Check if EXIT loop wires are connected into to loop input connector properly.</li> <li>Check if loop detector is inserted properly in Loop Rack slot.</li> <li>Set unique loop detector frequency for each loop detector used.</li> <li>Loop Detector might be defective. Replace defective loop detector.</li> </ul> <p>NOTE: RENO loop detector LED's flash as default, but function normally (ignore the flashing).</p>
"SAFETY" LOOP LED is FLASHING or constantly ON	OFF <b>17</b>	<ul style="list-style-type: none"> <li>Loop fault condition: check if SAFETY loop wires are connected into to loop input connector properly.</li> <li>Check if SAFETY loops are wired in series.</li> <li>Check if loop detector is inserted properly in Loop Rack slot.</li> <li>Set unique loop detector frequency for each loop detector used.</li> <li>Loop Detector might be defective. Replace defective loop detector.</li> </ul> <p>NOTE: RENO loop detector LED's flash as default, but function normally (ignore the flashing).</p>
"CENTER" LOOP LED is FLASHING or constantly ON	OFF <b>16</b>	<ul style="list-style-type: none"> <li>Loop fault condition: check if CENTER loop wires are connected into to loop input connector properly.</li> <li>Check if CENTER loops are wired in series.</li> <li>Check if loop detector is inserted properly in Loop Rack slot.</li> <li>Set unique loop detector frequency for each loop detector used.</li> <li>Loop Detector might be defective. Replace defective loop detector.</li> </ul> <p>NOTE: RENO loop detector LED's flash as default, but function normally (ignore the flashing).</p>
"GATE DISABLE" LED is ON	OFF <b>35</b>	<ul style="list-style-type: none"> <li>Check if an external device is triggering GATE DISABLE input. Disconnect devices individually to determine possible false triggering of GATE DISABLE.</li> </ul>
"MAG LOCK" LED is FLASHING	OFF <b>28</b>	<ul style="list-style-type: none"> <li>Maglock power is lost. Check if maglock power transformer is wired properly or needs to be replaced.</li> <li>Switch is set to delay but no maglock is connected. Set switch to OFF</li> </ul>
"GATE TAMPER" LED is FLASHING	OFF <b>34</b>	<ul style="list-style-type: none"> <li>Gate was manually moved off of its CLOSED position causing Tamper Relay to trigger for few seconds.</li> </ul>
"12VDC" LED is OFF. "24VDC" LED is OFF	ON <b>18 or 19</b>	<ul style="list-style-type: none"> <li>Check for a short in wiring to connected device. DO NOT power external keypads or telephone entry to this port (only use for radio receiver / photocell).</li> </ul>
"ON/OFF BATTERY" LED is OFF	ON <b>22</b>	<ul style="list-style-type: none"> <li>Batteries are turned OFF. Turn toroid box AC POWER switch ON and batteries automatically turn ON.</li> </ul>
"ANTI-TAILGATE" LED is ON	OFF <b>23</b>	<ul style="list-style-type: none"> <li>Anti-tailgate feature is turned ON. If this feature is not desired, turn Anti-tailgate OFF.</li> </ul>
"CLOSING GATE SPEED" LEDs are ON but gate moves slowly.	ON <b>40</b>	<ul style="list-style-type: none"> <li>ONLY Maximum settings will turn LEDs ON. All other settings, LEDs remain OFF.</li> </ul>

# COMMON SENSOR WIRING

## OMRON E3K-R10K4 WIRING

### Pre 2018 WITHOUT Built-in Resistor

#### NORMALLY CLOSED (NC) Wiring to E3K Photocell

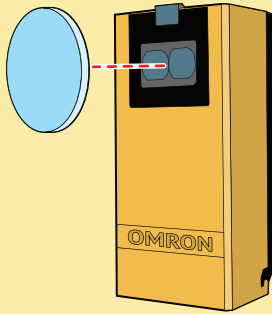

**CLOSING Direction**  
Photocell (Reflector)

**NOTE:** To meet the UL 325 2016 standard, Type B1 Non-Contact sensor entrapment protection device **MUST** be **MONITORED** by the gate operator.

#### Installation Steps:

1. Set switch to "LIGHT ON"
2. Wire 12V power to photocell
3. Wire **PHOTO CLS NC** to photocell **NO1**  
Wire **GND** to photocell **C-1**
4. Align photocell to reflector
5. Adjust sensitivity

**IMPORTANT:** Photocell **MUST** be in alignment with reflector or fault will occur.

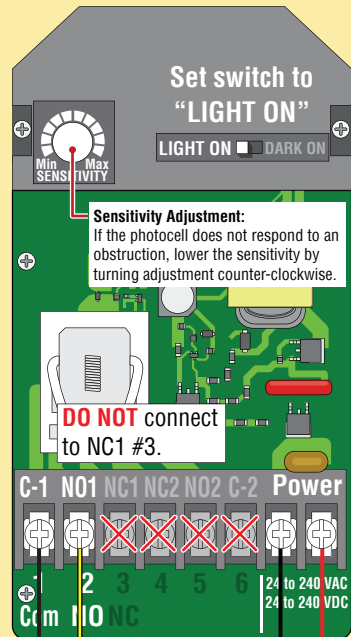

OK to use 12VDC

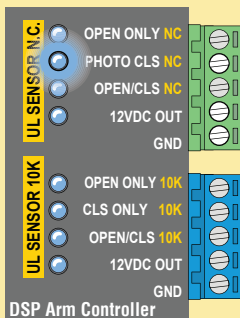

**IMPORTANT:** Photocell **MUST** be powered by **12VDC OUT MONITORED** or it will **NOT** be **MONITORED**.

**NOTE:** DO NOT use 10K Resistor included with photocell.

### Post 2018 WITH Built-in Resistor

#### NORMALLY CLOSED (NC) Wiring to E3K Photocell

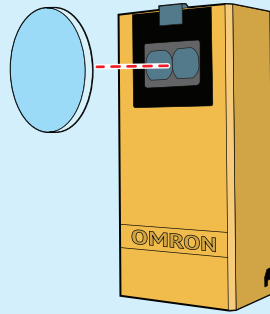

**CLOSING Direction**  
Photocell (Reflector)

UL 2018 Label on packaging

\*\*\*\*NEW!!!\*\*\*\*

E3K with Built-In Resistor to comply with UL325-2018 Requirements

\*\* Please consult enclosed wiring diagrams and operator instruction manual\*\*

**NOTE:** To meet the UL 325 2018 standard, Type B1 Non-Contact sensor entrapment protection device **MUST** be **MONITORED** by the gate operator.

#### Installation Steps:

1. Set switch to "LIGHT ON"
2. Wire 12V power to photocell
3. Wire **PHOTO CLS NC** to photocell **NO2**  
Wire **GND** to photocell **C-2**
4. Align photocell to reflector
5. Adjust sensitivity

**IMPORTANT:** Photocell **MUST** be in alignment with reflector or fault will occur.

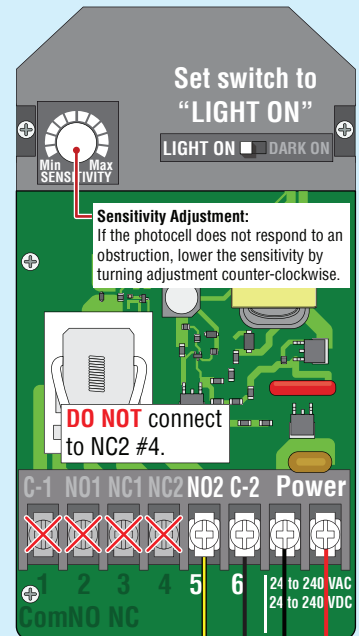

OK to use 12VDC

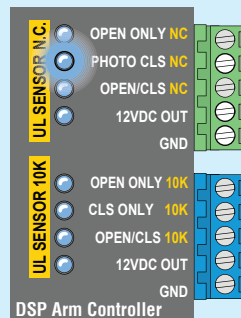

**IMPORTANT:** Photocell **MUST** be powered by **12VDC OUT MONITORED** or it will **NOT** be **MONITORED**.

**For 10K Resistor E3K Photocell wiring see next page**

## UL325 - 2018 Compliance

### 10K Resistor Wiring to E3K Photocell

**Installation Steps:**

1. Set switch to "LIGHT ON"
2. Wire 12V power to photocell
3. Wire **PHOTO CLS NC** to photocell **NO1**  
Wire **GND** to photocell **C-1**
4. Align photocell to reflector
5. Adjust sensitivity

**IMPORTANT:** Photocell **MUST** be in alignment with reflector or fault will occur.

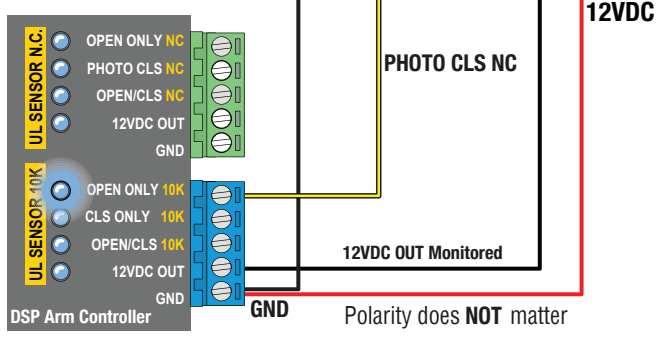
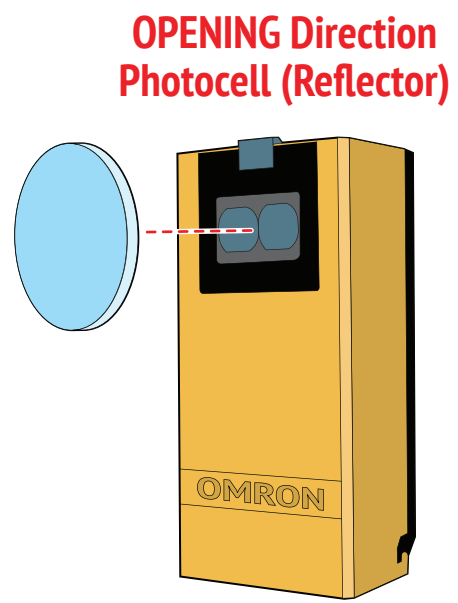
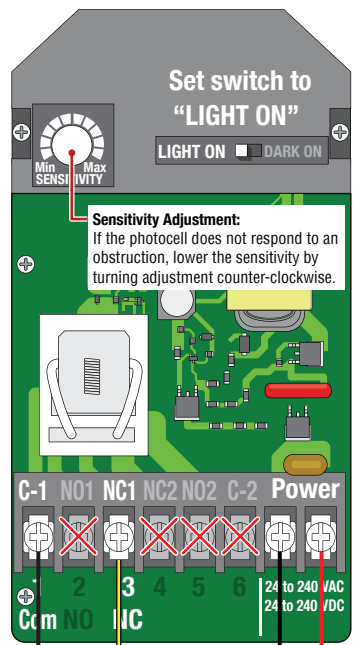

**UL 2018 Label on packaging**

**\*\*\*\*\*NEW!!!\*\*\*\*\***

E3K with Built-In Resistor to comply with UL325-2018 Requirements

**\*\* Please consult enclosed wiring diagrams and operator instruction manual\*\***

**NOTE:** To meet the UL 325 2018 standard, Type B1 Non-Contact sensor entrapment protection device **MUST** be **MONITORED** by the gate operator.

**IMPORTANT:** Photocell **MUST** be powered by **12VDC OUT** or it will **NOT** be **MONITORED**.

# EMX WEL-200 MONITORED WIRELESS

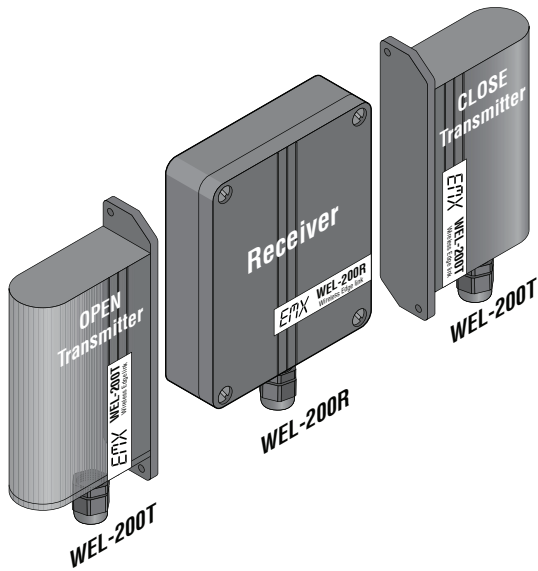

The WEL-200 is a complete wireless solution for interfacing sensing edges to gate and door operators, while ensuring compliance with UL325 monitoring standards. **Each receiver can connect with up to four transmitters** with separate relay and pulse outputs for open and close edge functionality. Each transmitter can run for up to two years on two AA lithium batteries. With enhanced diagnostic features, installation and maintenance for the WEL-200 is easy and reliable. Feedback is provided for all fault modes, including edge open, short conditions, low battery and failed transmitters. See next page to connect receiver to transmitter.

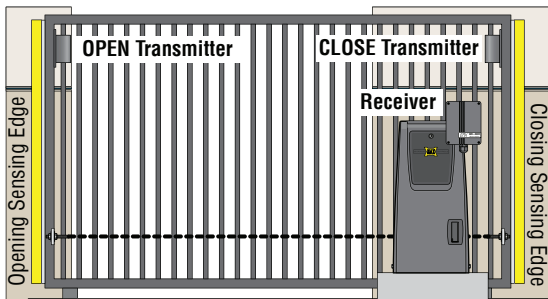

Typically used on SLIDE gates

## 10K Resistor Wiring to WEL-200 Wireless

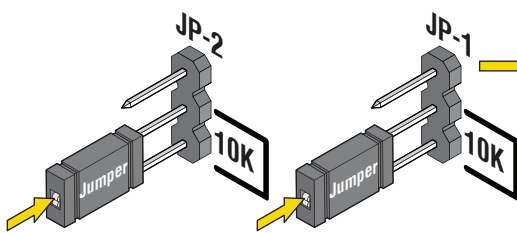

Set both jumpers to 10K position

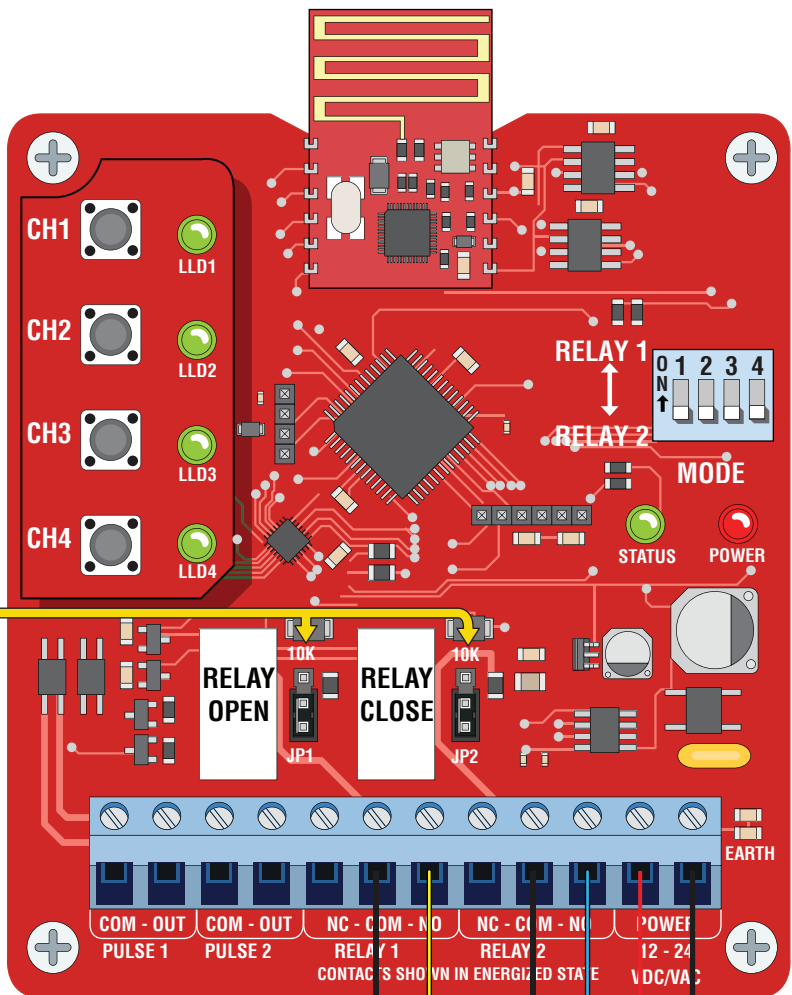

### Wire to 10K Inputs

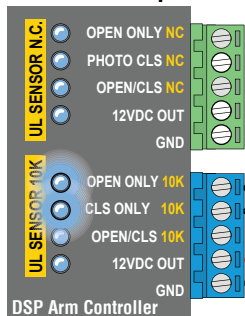

Wire to (NO) of Relay 1

Wire to (NO) of Relay 2

12VDC OUT Monitored

Polarity does NOT matter

# CONNECTING RECEIVER TO TRANSMITTER

WEL-200R Receiver



WEL-200T Transmitter

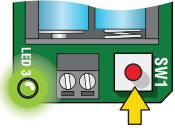

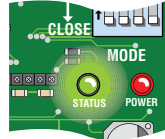

Connecting is a two step process. First, on the receiver, press and hold the channel assignment switch until the green status LED begins rapidly flashing, then release; this will clear any existing assignment for that particular channel. Hold down the connection switch on the transmitter. If it is not currently connected to a receiver, it will begin flashing rapidly until successfully connecting. Detailed instructions are given below.

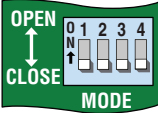
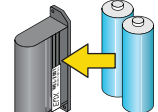

**NOTE:** If there are no existing connections, the receiver's status LED will blink rapidly while it is finding a clean operating frequency (this can last a few seconds) After initialization, the system status LED will flash on/off once every 2 seconds post)

## STEPS

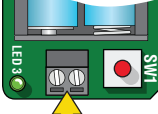
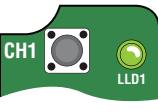
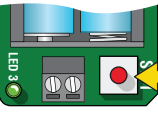
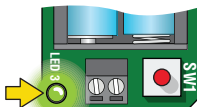
- 1**  Set each channel to the desired OPEN/CLOSE direction function using the MODE dip switch. If a DIP switch is in the OPEN (ON) position, then that channel will trigger the OPEN relay on receiver. Otherwise it will trigger the CLOSE relay, CLOSE (OFF) position.
- 2**  Install 2 AA Lithium batteries in the WEL-200T (transmitter)
- 2**  The green LED on the transmitter will quickly flash 2x every two seconds
- 3**  Install a properly terminated edge to the transmitter (8.2k or 10k termination)
- 4**  On the receiver, hold down the desired channel assignment switch until all four channel LED's activate and the system status LED begins flashing rapidly, then release the switch.
- 5**  On the transmitter, hold down the connection switch (next to the terminal block). The LED on the transmitter will begin flashing rapidly after ~4 seconds
- 5**  Upon successful connection, the LED will flash once every two seconds If the transmitter fails to connect, it will return to its initial state, with the LED flashing twice every two seconds. If this occurs, repeat steps above

## TESTING

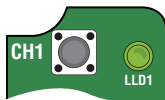

Without activating the edge, observe the receiver channel status LED, it should be OFF.



When the edge is activated, the receiver channel status LED will turn on and the corresponding OPEN/CLOSE direction output will activate.

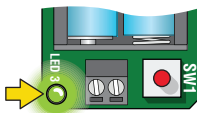

The transmitter status LED will blink once every second when the edge is activated. If the channel does not exhibit this behavior, double check the edge wiring/termination and transmitter batteries.

# EMX IRB-RET2 WIRING

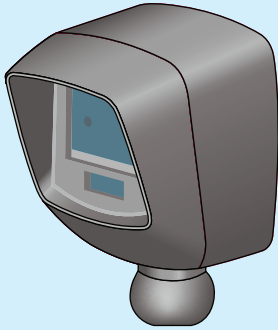

**IMPORTANT:** Photocell MUST be powered by 12VDC OUT or it will NOT be MONITORED.

NOTE: To meet the UL 325 2018 standard, Type B1 Non-Contact sensor entrapment protection device MUST be MONITORED by the gate operator.

## Photocell (Reflector) CLOSING Direction

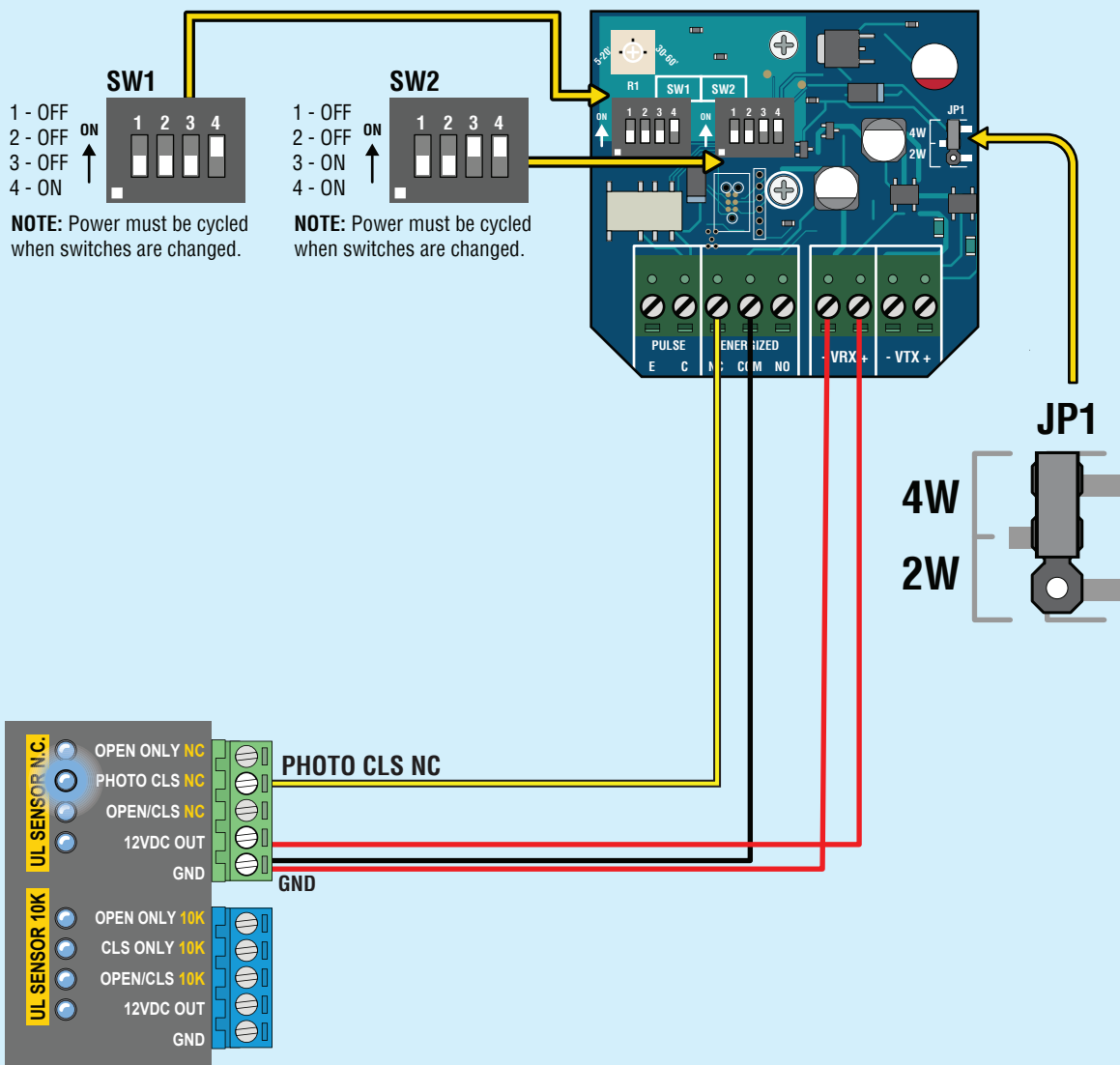

# COMMON SENSOR WIRING

## EMX IRB-RET

### Installation Steps:

1. Set DIP-switches
2. Remove jumper JP-5
3. Insert jumper on 4W JP-6
4. Wire 12V power to photocell (VRX)
5. Wire DSP board **PHOTO CLS NC** to photocell **NC (Energized)**  
Wire DSP board **GND** to photocell **COM (Energized)**
6. Align photocell to reflector
7. Adjust sensitivity

**IMPORTANT:** Photocell **MUST** be powered by **12VDC OUT** or it will **NOT** be **MONITORED**.

NOTE: To meet the UL 325 2018 standard, Type B1 Non-Contact sensor entrapment protection device **MUST** be **MONITORED** by the gate operator.

### Photocell (Reflector) CLOSING Direction

**Sensitivity Adjustment:**  
If the photocell does not respond to an obstruction, lower the sensitivity by turning adjustment counter-clockwise.

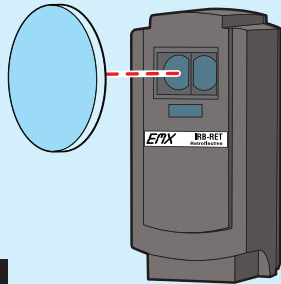
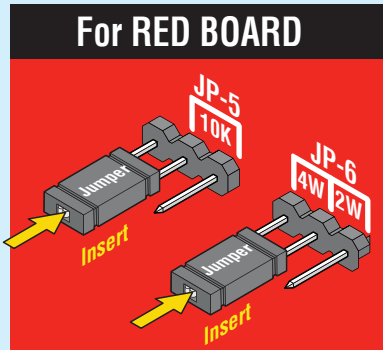

#### DIP-Switches

- |         |   |   |   |   |   |
|---------|---|---|---|---|---|
| 1 - OFF | 0 | 1 | 2 | 3 | 4 |
| 2 - OFF | N |   |   |   |   |
| 3 - OFF | ↑ |   |   |   |   |
| 4 - ON  |   |   |   |   |   |

NOTE: Power must be cycled when switches are changed.

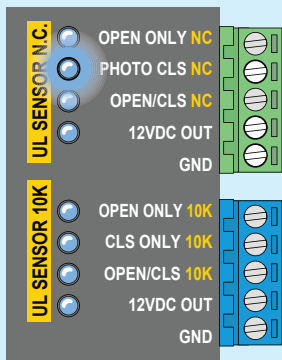
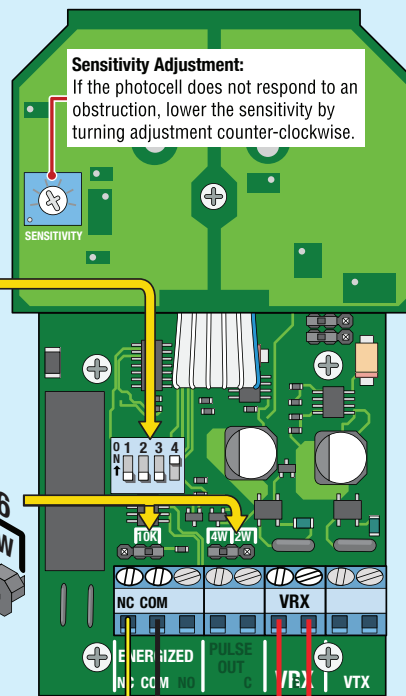
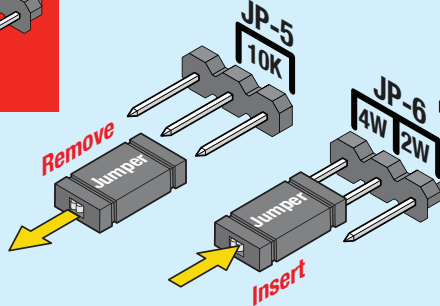

PHOTO CLS NC

GND

12VDC OUT  
Polarity does NOT matter

# Blue Transmitter (TX) / Red Receiver (RX) Boards

## EMX IRB-MON Photocell (Thru-Beam) CLOSING Direction Single Gate Operator

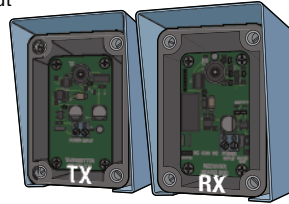
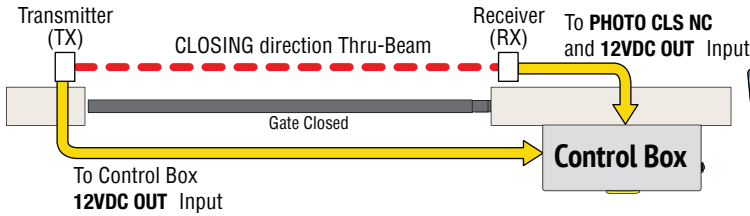

**IMPORTANT:** Photocells **MUST** be in alignment or fault will occur. Green LED will remain **ON** receiver when in proper alignment.

### Transmitter (TX)

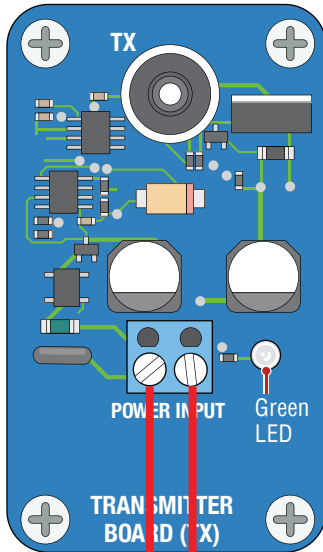

### Installation Steps:

1. Set DIP-switches on receiver.
2. Install jumper on receiver.
3. Wire DSP 12VDC OUT power to receiver.
4. Wire PHOTO CLS NC to receiver photocell NC. Wire DSP Board GND to receiver photocell COM.
5. Wire 12V DSP power to transmitter.
6. Align photocells.
7. Adjust sensitivity on receiver.

**Sensitivity Adjustment:**  
If the photocell does not respond to an obstruction, lower the sensitivity by turning adjustment counter-clockwise.

### DIP-switches:

1, 2, 4 are **OFF**.  
Switch 3 is **ON**.  
If trouble occurs, try turning switch 4 **OFF**.  
**NOTE:** Power must be cycled when switches are changed.

### Receiver (RX)

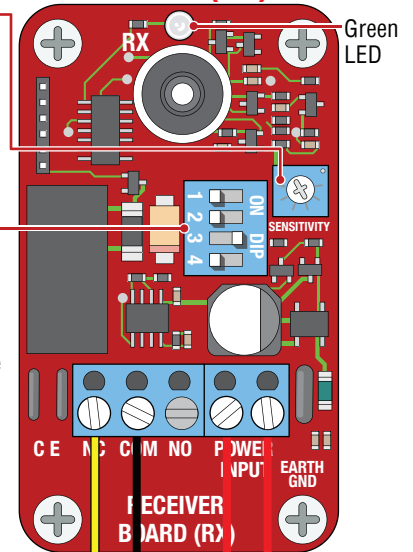

**IMPORTANT:** Photocells **MUST** be powered by **12VDC OUT** or they will **NOT** be **MONITORED**.

**12VDC OUT**  
Polarity does **NOT** matter

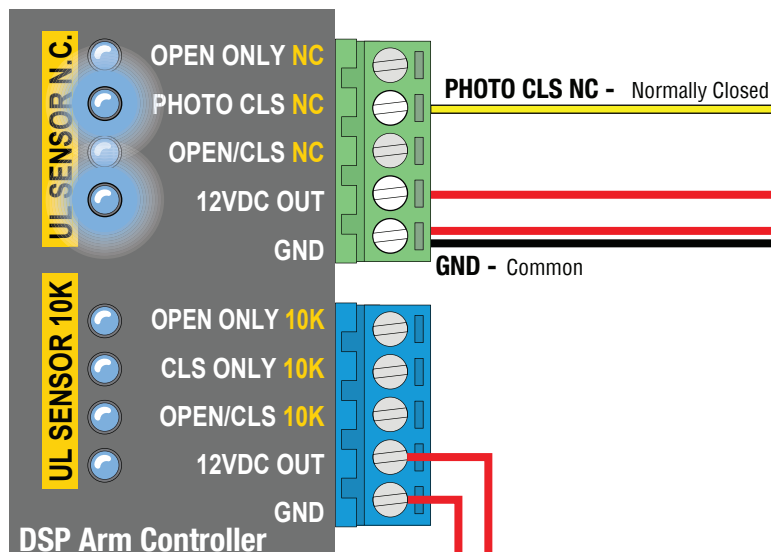

**NOTE:** To meet the UL 325 2018 standard, Type B1 Non-Contact sensor entrapment protection device **MUST** be **MONITORED** by the gate operator.

# Green Transmitter (TX) / Green Receiver (RX) Boards



## Photocell (Thru-Beam) CLOSING Direction Single Gate Operator

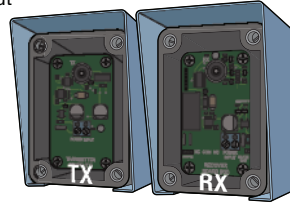
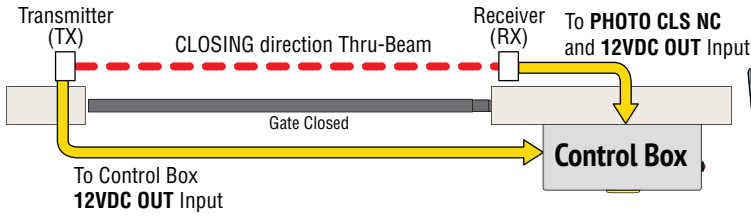

**IMPORTANT:** Photocells **MUST** be in alignment or fault will occur. Green LED will remain **ON** receiver when in proper alignment.

### Transmitter (TX)

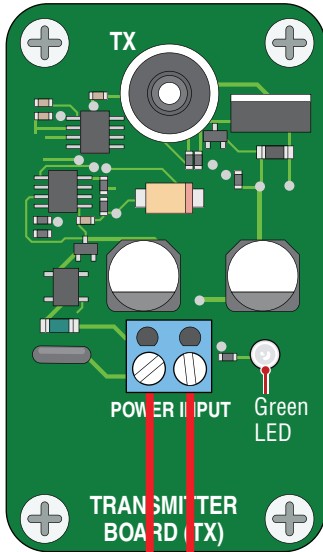

#### Installation Steps:

1. Set DIP-switches on receiver.
2. Install jumper on receiver.
3. Wire DSP 12VDC OUT power to receiver.
4. Wire PHOTO CLS NC to receiver photocell NC. Wire DSP Board GND to receiver photocell COM.
5. Wire 12V DSP power to transmitter.
6. Align photocells.
7. Adjust sensitivity on receiver.

### Receiver (RX)

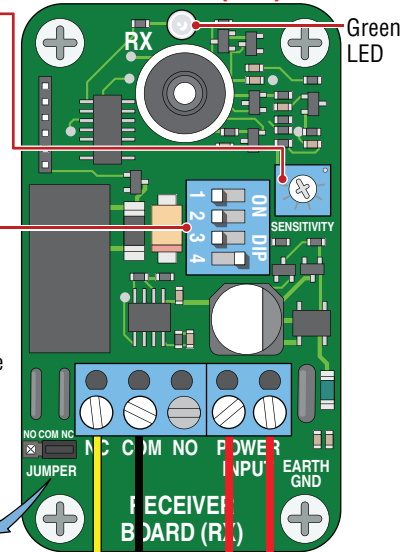

**Sensitivity Adjustment:**  
If the photocell does not respond to an obstruction, lower the sensitivity by turning adjustment counter-clockwise.

**DIP-switches:**  
1, 2, 3 are OFF. Switch 4 is ON  
If trouble occurs, try turning switch 4 OFF.  
**NOTE:** Power must be cycled when switches are changed.

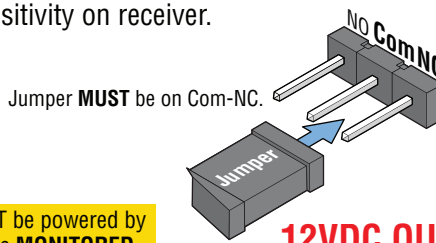

**IMPORTANT:** Photocells **MUST** be powered by **12VDC OUT** or they will **NOT** be **MONITORED**.

**12VDC OUT**  
Polarity does **NOT** matter

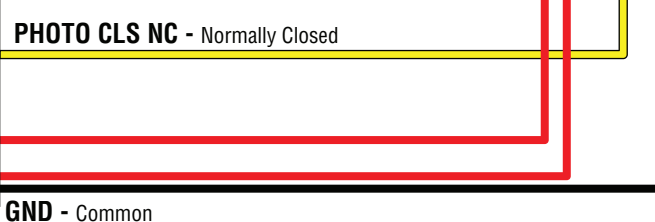
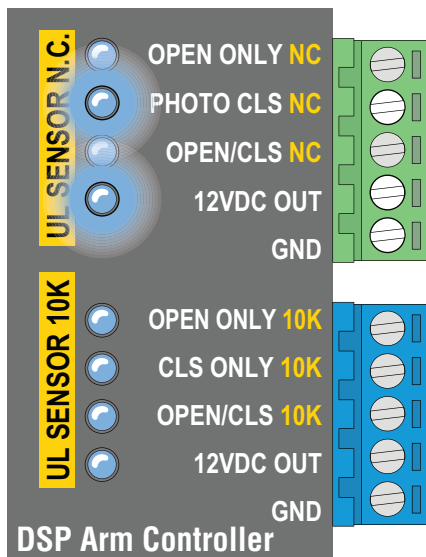

**NOTE:** To meet the UL 325 2018 standard, Type B1 Non-Contact sensor entrapment protection device **MUST** be **MONITORED** by the gate operator.

# MILLER R-BAND MONITORED WIRELESS

Channel 1 & 2 transmitters **MUST** be programmed by RBAND receiver. See below or Miller Edge Wireless RBAND instruction sheet to program transmitters to receiver.

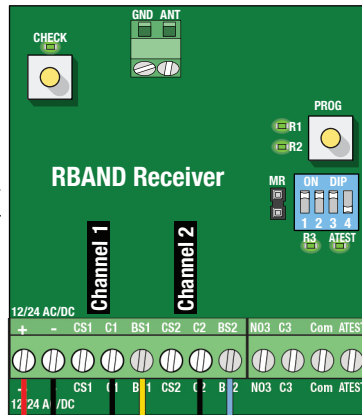

**DIP-Switches**  
 1-ON  
 2-ON  
 3-ON  
 4-OFF

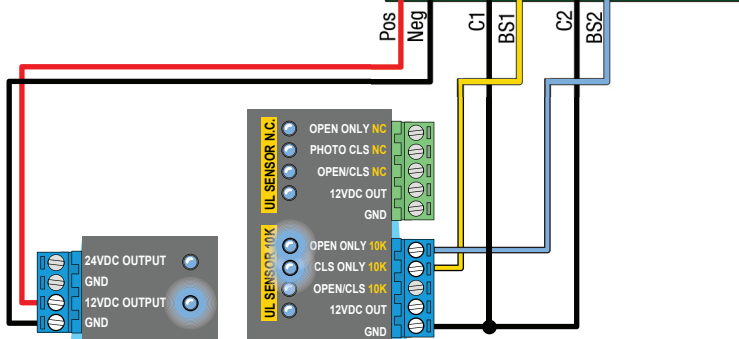
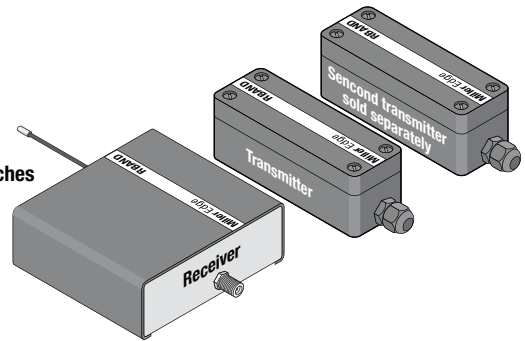

## Wire 10K Edges

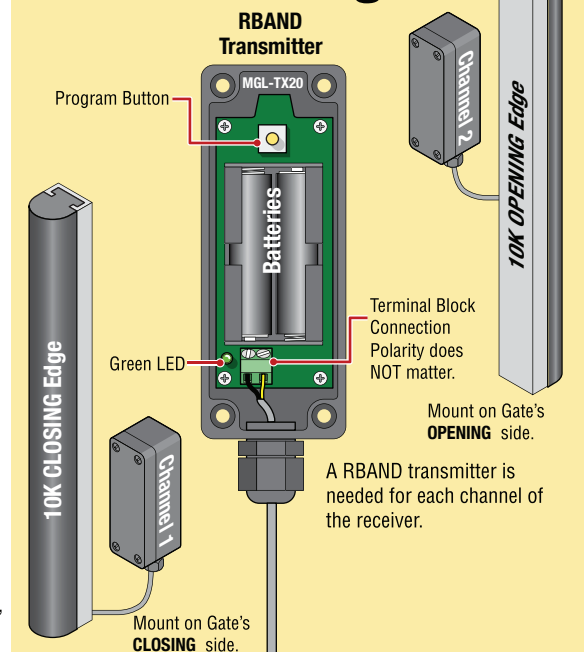

**Channel 1 - CLS ONLY 10K CLOSING direction ONLY**  
**Automatically MONITORED.**

**Channel 2 - OPEN ONLY 10K OPENING direction ONLY**  
**MUST be LEARNED to monitor sensor,**  
 See Step 15.

**NOTE: Channel 2 sensor will function without being "Learned" but will NOT be MONITORED by the gate operator.**

## Wireless Receiver/Transmitter Programming:

1. Make sure receiver and transmitters have power.
2. Green power LED will be blinking on channel 1 transmitter (unlearned).
3. To enter learn mode, press and hold the receiver program button for ~2 seconds until the R1 LED turns on, then release the button.
4. Press the transmitter program button for ~2 seconds. The receiver will beep. Wait 10 seconds for an additional beep to complete programming.
5. To program a transmitter to channel 2, press and hold the receiver program button until the second beep, then release the button. The R2 LED should be on. Repeat step 4 for channel 2 transmitter.

**ERASE PROGRAMMING** . If you need to replace a transmitter or you have any other programming issues, you may need to erase the receiver.

1. To erase transmitters programmed into the receiver, use a screwdriver to short the two pins marked MR next to the DIP-switches.
2. While shorting the pins, press and hold the program button for several seconds; you will hear a series of 10 beeps followed by a rapid chirping sound.
3. When the chirping stops, release the program button. Wait ~10 seconds and you will hear 2 beeps. The receiver is now ready to be reprogrammed.

# I GAZE RE KIT MONITORED WIRELESS

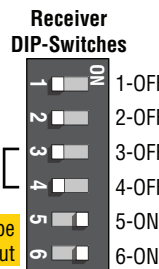
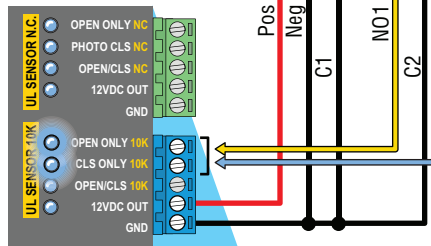
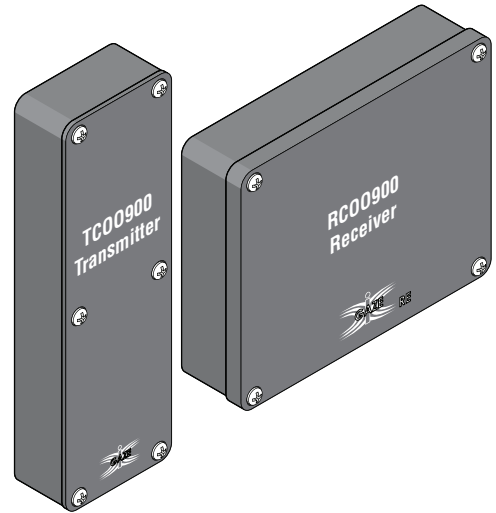
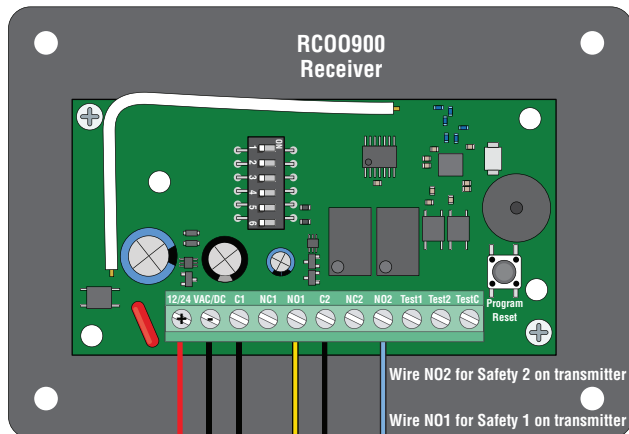

5 & 6 MUST be ON for 10K input

Both safety edges are 10KΩ resistive

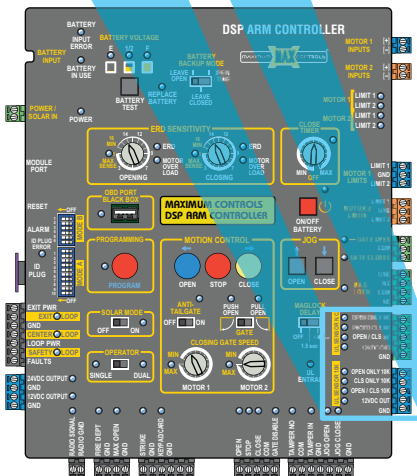

## Wire 10K Edges

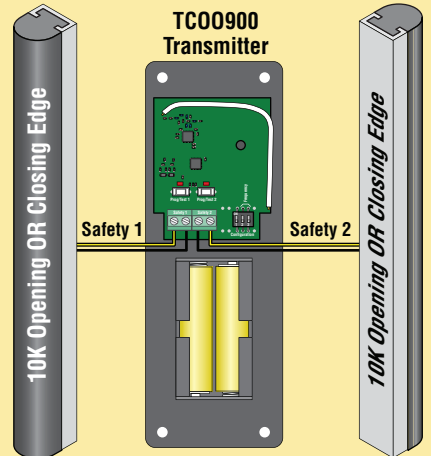

Can be mounted on Gate's **OPENING OR CLOSING** position.

Can be mounted on Gate's **OPENING OR CLOSING** position.



Set to **OFF**

Frequency DIP-switches 2 & 3 **MUST** be set the same as the receiver DIP-switches 3 & 4.

## Wireless Receiver/Transmitter Programming:

1. Make sure receiver and transmitter have power.
  2. Press and HOLD **PROGRAM/RESET** button on **receiver** until **ONE** "BEEP" is heard. Release button.
  3. Press and HOLD **PROG/TEST 1** button (Safety 1) on **transmitter** until **TWO** "BEEPS" are heard. Release button.
- Repeat steps for **PROG/TEST 2** button (Safety 2) on **transmitter** if second edge is used.

**NOTE:** See iGaze RE Wireless kit instruction sheet for **complete** installation and programming instructions.

Mount transmitter as high as possible on gate. Minimum of 8" above ground.

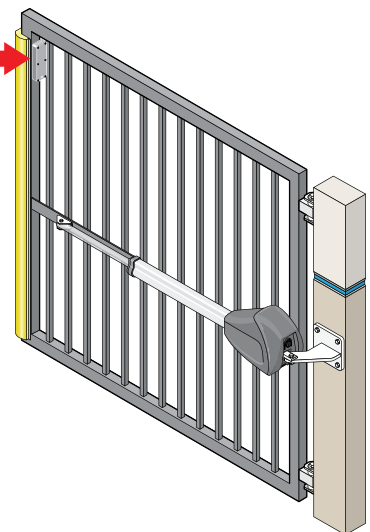

# DSP CIRCUIT BOARD OVERVIEW

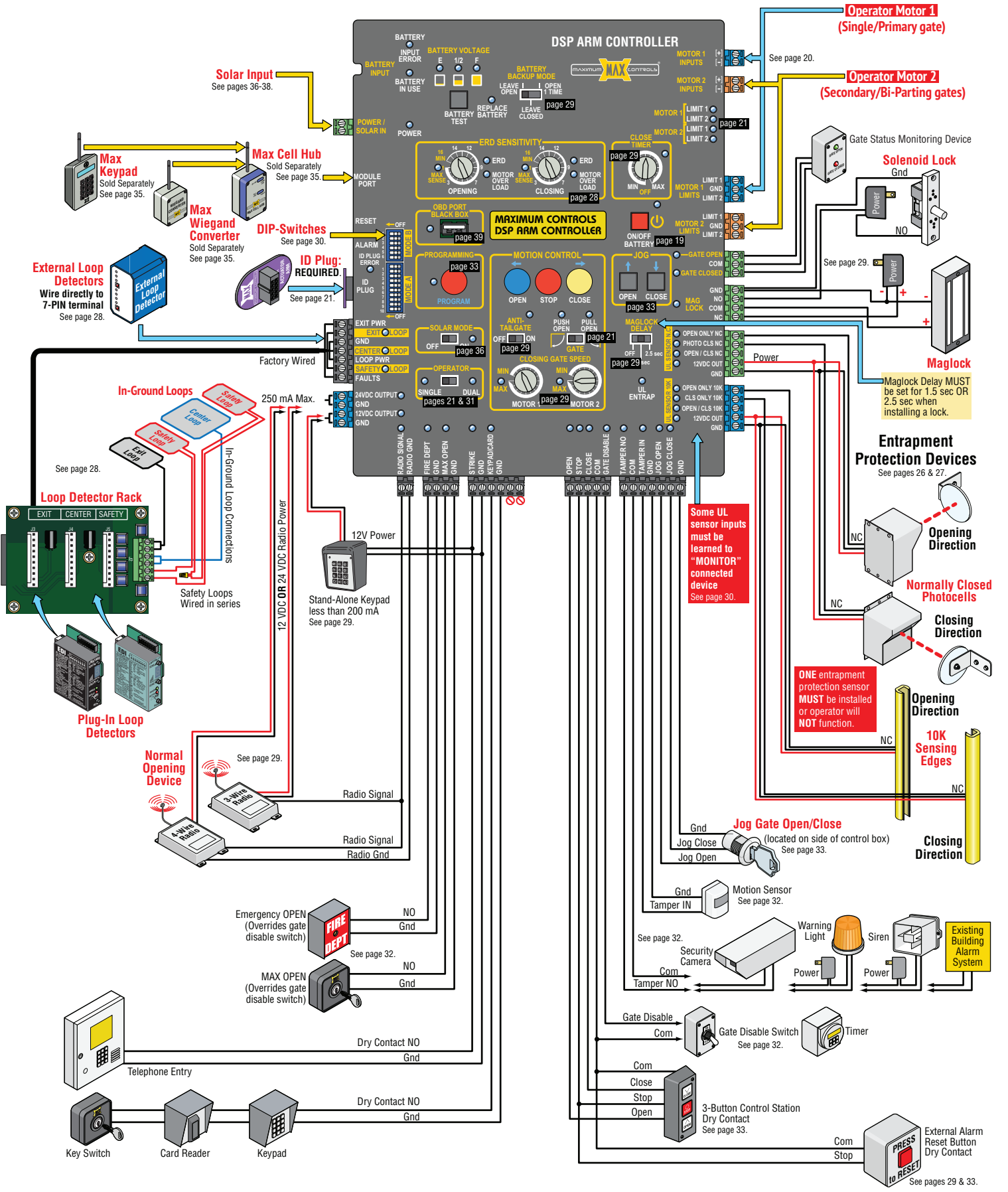

# MANUALLY RELEASE GATE

MAX SUPER ARM 1300

## MAX SUPER ARM 1300

1 Insert key and turn 90°.

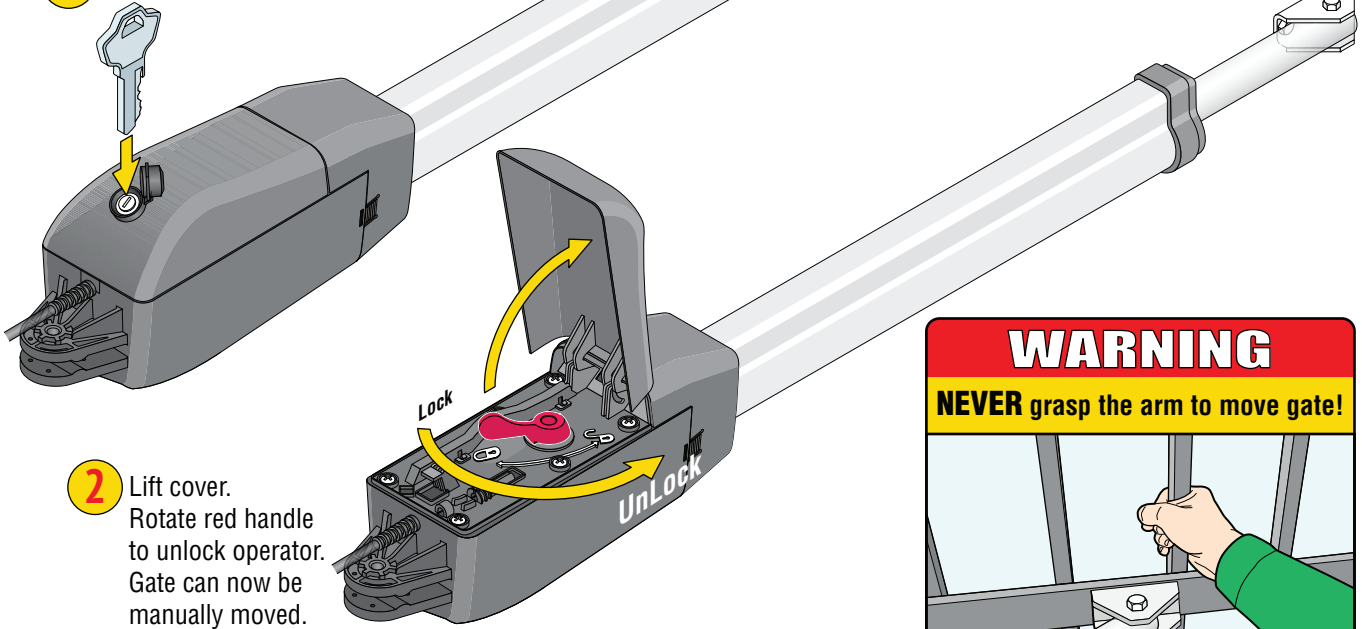

2 Lift cover. Rotate red handle to unlock operator. Gate can now be manually moved.

**WARNING**  
NEVER grasp the arm to move gate!

**ALWAYS** grasp gate to move it.

**OWNER** of the gate operator is responsible for the **KEY** availability.

**ALWAYS** verify that power is **OFF** BEFORE manually releasing gate!

## MAX SUPER ARM 2300

1 Insert key and turn 90°.

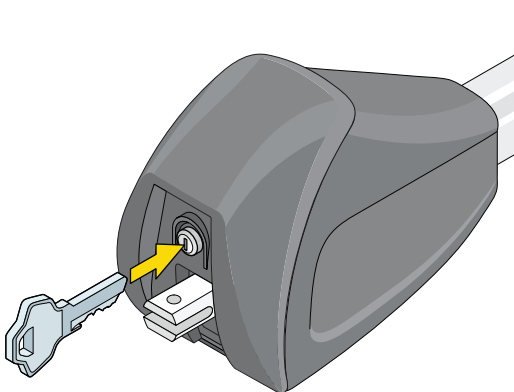

2 Lift back cover. Gate can now be manually moved.

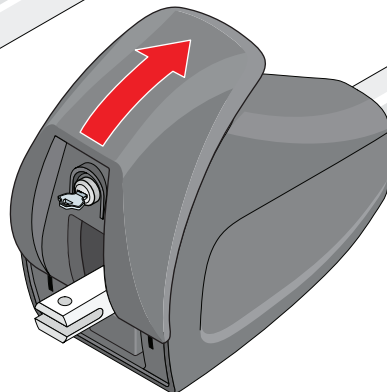

MAX SUPER ARM 2300



# Installation and Owners manual for

**MAX SUPER ARM 1300**

**MAX SUPER ARM 2300**

## Actuator Arms

**SAFETY SENSORS REQUIRED**

CONFORMS TO UL STD 325  
UL CLASS - I, II, III, IV

CERTIFIED TO CAN/CSA STD  
C22.2 NO. 247

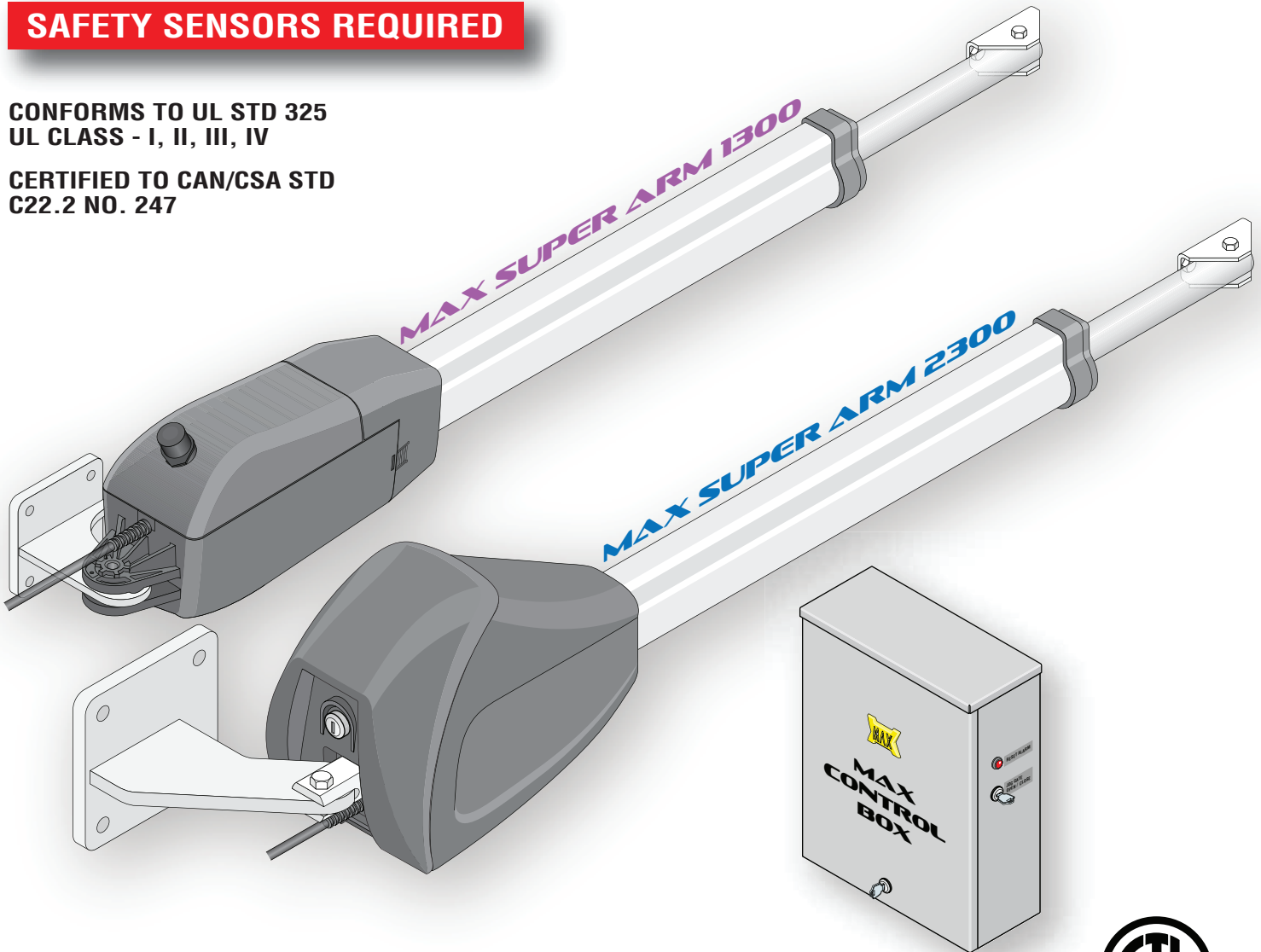

## Residential / Commercial Linear Gate Operators



Intertek  
4009963