



MEGATRON 2200 HP PRO

High-traffic Commercial
Brushless DC Swing Gate Operator
The Maximum Level of Gate Control



5 YEAR WARRANTY
PLEASE READ
WARRANTY POLICY

TRUE SECURITY... DSP MOTION CONTROL... HIGH PERFORMANCE
SAFETY SENSORS REQUIRED FOR UL 325 2018



MECHANICAL SPECIFICATIONS

- Megatron 2200 HP PRO dimensions (16.81" W x 24.5" D x 29.92" H) 26.61" arm height
- ✔ Heavy duty dual gear box 900:1 Size 80 for Megatron 2200 HP PRO
- Megatron 2200 HP PRO capacity 2500lbs/15ft or 1800lbs/20ft - gate speed 11½ to 18 seconds
- ✔ Large output shaft: 3¼" diameter solid steel with cast iron clamping system
- ✔ Direct gear drive (no chains, belts, or pulleys)
- ✔ Mechanical and electrical manual gate release functions
- Corrosion protection gold zinc coating
- ✔ Continuous cycle at extreme temperature range; no overheating possibilities
- ✔ Intelligent ramp-up and ramp-down gate speed control for smooth operation
- Shipping weight of Megatron 2200 HP PRO: (250 lbs)

ELECTRICAL SPECIFICATIONS

- ✔ Brushless DC motor equivalent to 1 1/4 HP AC motor
- ✔ Selectable switch for uphill gates and windy conditions
- ✔ Programmable gate speed controls, 16 selectable speeds
- ✔ Automatic gate position reset system
- ✔ Gate sync feature provides automatic gate movement synchronization
- Modular system design for ease of service
- Switchable 115/230V AC selection
- ✔ Adaptive DSP control for advanced brushless DC motion control
- ✔ Real time performance analyzer and event log (OBD PORT and Black Box)
- ✔ Low voltage wiring capabilities for remote power up to 1000 ft (no battery needed)
- ✔ 'Solar Ready' battery module with built-in advanced solar regulator
- Intelligent power management system with energy saver mode
- Built-in 12vdc and 24vdc outputs
- ✔ Gold contact input connections and automobile grade connectors
- Selectable open timer 0 to 60 seconds with 'timer off' option
- -4F to 165F (-20C to +74C) operational temperature range including battery performance without needing a heater
- ✔ Robust lightning protection up to 20KVolts and 10KAmps on all inputs and outputs (44 Channels) including loop detector input connections
- ✔ Tunable 16-position safety obstruction sensor, auto adaptable to gate weight and size
- ✔ Dual motor overcurrent safety shut-off for additional protection
-

✔ = Unique to Megatron 2200 HP PRO

- Every operator includes a batteries providing 400 cycles in case of power failure
- Three modes of selectable battery backup functions
- ✔ State machine design electronics with ultra-fast microprocessor
- On-board three button station

SECURITY SPECIFICATIONS

- ✔ High-traffic intuitive loop management system for better security
- ✔ Advanced security features with built-in audible and remote alarms
 - Magnetic lock control relay outputs with selectable delay times
- ✔ Tamper alert relay output triggers “on” if gate is forced open
- ✔ Audible alarm if gate is tampered with or ERD is triggered for higher security
- ✔ Gate partial open recorder
- ✔ Lockable cover with key lock release to prevent intruders and vandalism
- ✔ Gate disable feature disables all inputs with exception of the fire department input for high security
- ✔ Built-in transaction buffer for high security
- ✔ Gate status outputs for gate monitoring
- ✔ Direct motor control of jog OPEN/CLOSE for manually moving a gate in case of emergency
 - Advanced anti-tailgate features to provide higher security
- ✔ No need for magnetic lock with the robust output shaft and clamp design of the Megatron 2200 HP PRO

SAFETY SPECIFICATIONS

- Adaptive obstruction sensor for much better gate safety system. 16 selectable sensitivity settings
- UL 325/991 compliant Class I, II, III, and IV. CSA approved
- Pinch arm protection design
- ✔ Dynamic magnetic brake system stops the gate immediately to prevent damage to obstructions
- ✔ Vehicle hit protection technology protects the gate operator from collision damage caused by automobile impact, avoiding costly repairs
- ✔ Built-in advanced entrapment protection and alarm output
 - Built-in gate-in-motion alarm for industrial applications

✔ = Unique to Megatron 2200 HP PRO

OPTIONAL

MAX CLOUD APP

Affordable and unique APP control solution for the residential and commercial gate operator market.
Compatible with Max Operators except Phantom F6 and 2000 Plus



  Smartphone · Tablet



VIRTUAL TRANSMITTER:

- To open or close a gate from anywhere in the world - via Max Cloud App
- Supports >10,000 virtual transmitters



QUICK & RELIABLE APP COMMANDS:

- App uses a dedicated cloud server to issue gate OPEN & other commands within a second.
- Cellular data connectivity is more reliable than WiFi due to range limitations.
- Cloud based app does not use text messaging which has unpredictable delays.



MANAGE GATE SITES USING MAX CLOUD APP:

- Add Admin users that can manage the gate site database.
- Add users with optional time restrictions
- Issue temporary Guest Passes for visitors
- With Max Keypad option: Program keypad keycodes, Wiegand keycodes for card readers, radio receivers and transponders with time restrictions
- Setup Auto Open / Close Timer for Max operators
- Retrieve Event log
- Retrieve Operator Diagnostics info: Error log



MULTIPLE GATE SITES SUPPORTED BY MAX CLOUD APP

- Gate sites can be controlled and monitored individually via app



SIMPLE AND SECURE APP LOGIN :

- Securely login to app using Cloud based authentication code. This avoids the need to remember passwords



USER FRIENDLY MENUS:

- Easy to program App Users & Guest passes with time restrictions.
- All programming is done on Max Cloud App - not a website portal

MAX MEGATRON 2200 HP PRO

High Profile, High-traffic Commercial Brushless 24 V DC Swing Gate Operator

- Continuous duty cycle
- 5 yrs warranty
- Battery 1 yr warranty
- Gate Capacity 2500 lbs /15 ft or 1800 lbs/ 20 ft
- UL 325 class of operation I, II, III, IV
- 90° opening 11½ to 18 seconds; dependent on motor speed setting
- Built-in battery backup; providing a minimum of 400 cycles

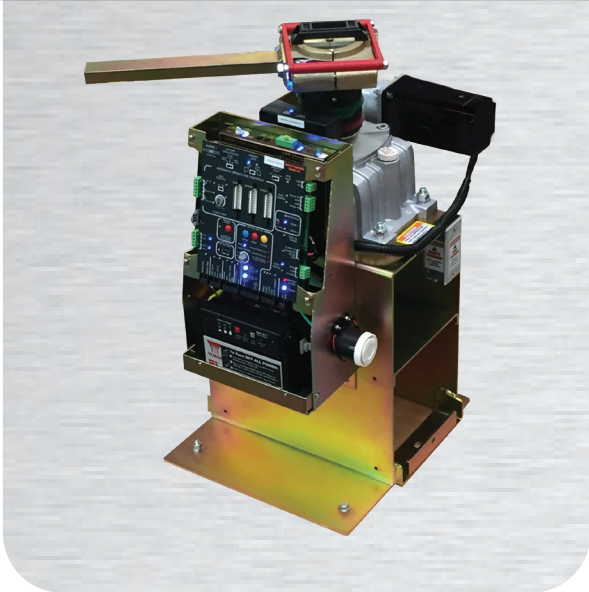

Input AC Power/Amps - Switchable: 115VAC / 6 Amp, Single Phase or 230AVC / 2 Amp, Single Phase

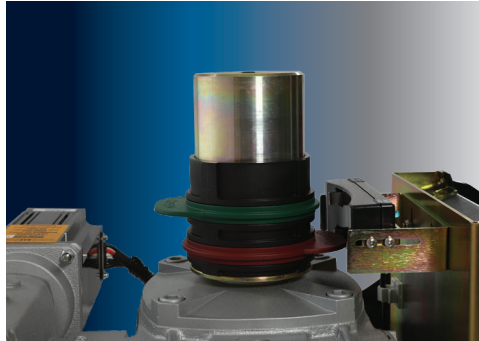

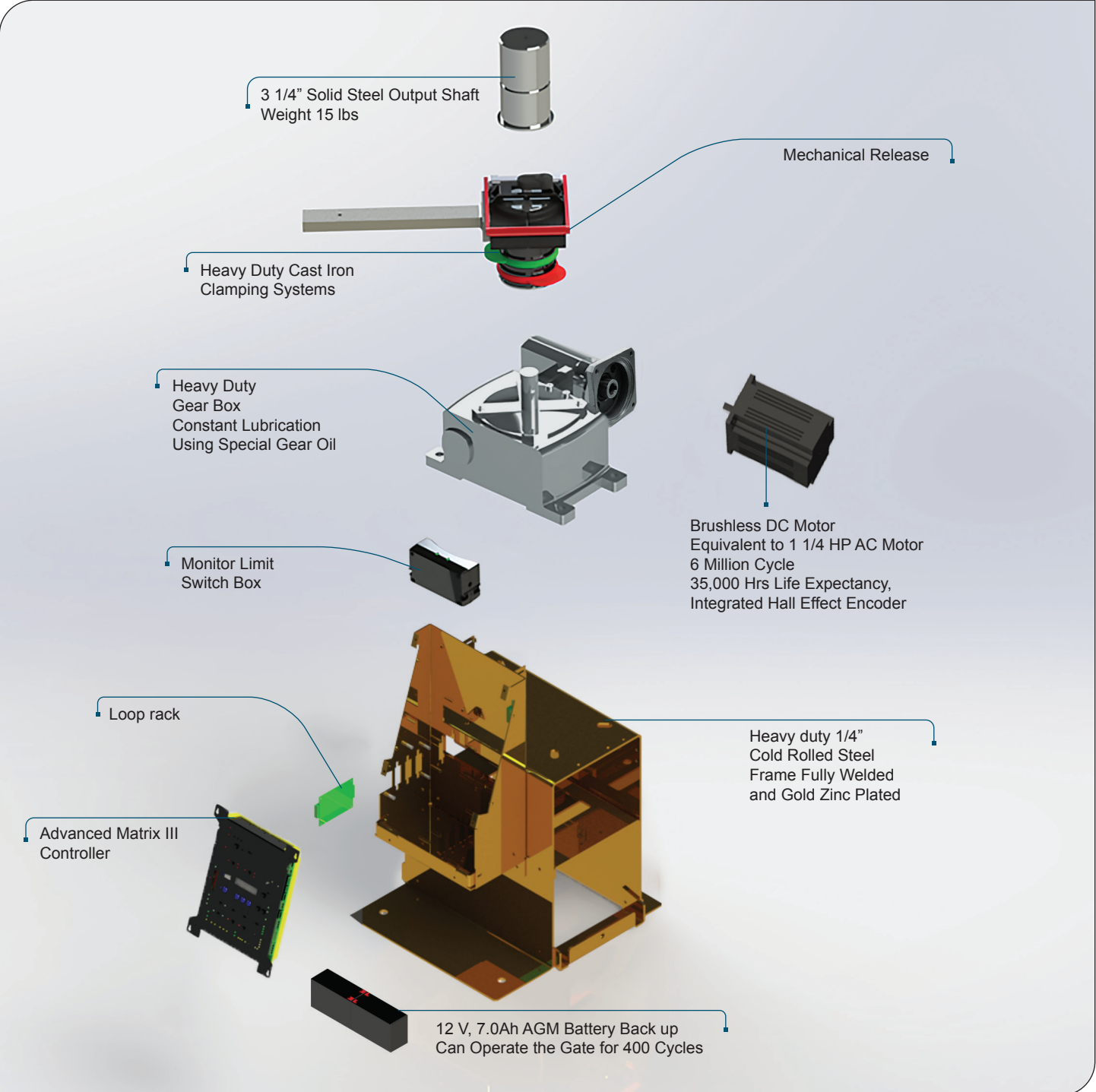
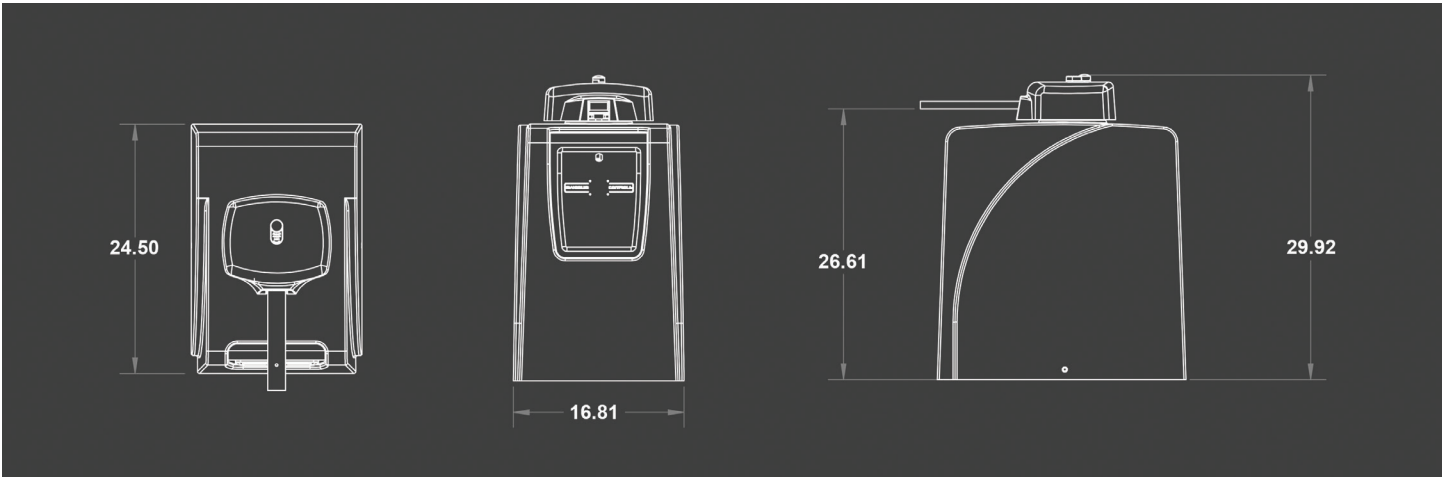

MECHANICAL RELEASE

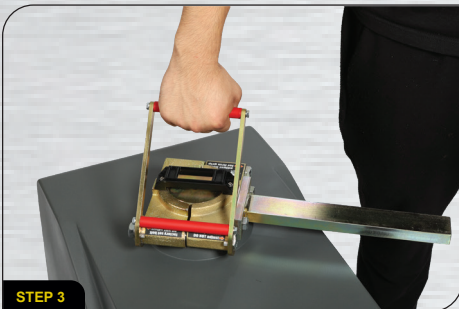
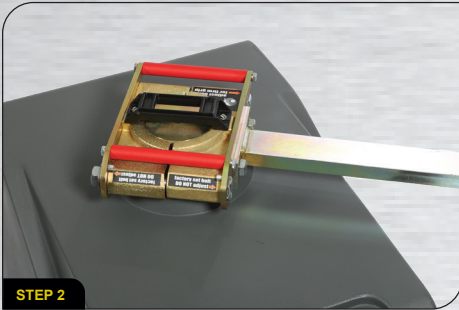

In case of a technical difficulty, the Megatron 2200 HP PRO has two manual release solutions. The first solution is the JOG OPEN & JOG CLOSE function. The JOG OPEN & JOG CLOSE function works by bypassing all Matrix-1 board inputs, serving as an electro-manual release solution even when the operator is not getting AC power but is still relying on battery backup. By installing an external "constant pressure switch" the JOG OPEN & JOG CLOSE feature can be accessed remotely.

The second solution is a mechanical manual release of the gate operator. Simply unlock the cap with a key, remove the cap and lift the red handle. The clamp is now loose and the gate can be pushed open manually. Manually releasing the operator in this manner will trigger the 'gate-tamper' relay while simultaneously triggering the operator's on-board UL buzzer. If the mechanical manual release is unauthorized, the gate tamper can trigger a security system. This is a high-security feature not found in any other gate operator.

OPTIONAL FEATURE Max External Jog Switch

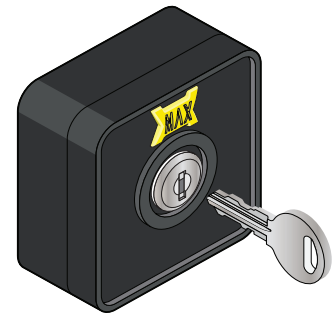

VEHICLE HIT PROTECTION

Maximum Controls recognizes swing gates are more prone to vehicular collisions. For this reason the Megatron 2200 HP PRO is outfitted with Maximum Controls' clamping technology constructed with robust cast iron. The clamp grips onto a 3/4" diameter machined steel output shaft assuring maximum grip without the use of a shear pin/plate; allowing slippage in an event that the gate is struck while in motion by a vehicle. This prevents damage to the operator while preserving limit switch locations.

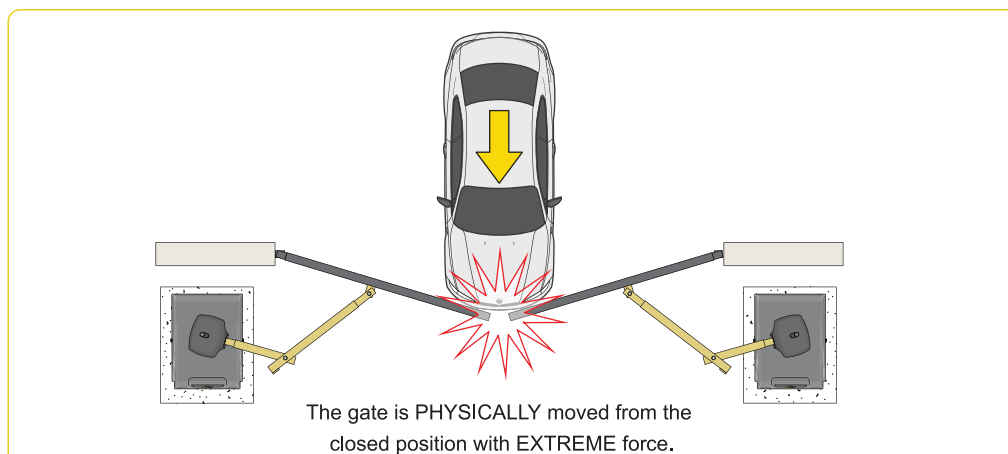

APPLICATION USE



After ten years in business here 10 reasons Maximum Controls is a technological leader in the industry.

- Long life motor capable of 5 million cycles
- The most robust lightning protection available in the industry
- Branded reliability
- Dependable diagnostic tools, LCD display and USB download
- The most quiet machines on the market
- Superior gate control and motion, true RPM ramp up, ramp down
- Reliable battery back up standard on all models
- Years of reliable operation in extreme temperatures, Phoenix to Winnipeg
- The only proven solution to windy conditions
- Direct gear drive, super quiet, minimum moving parts

These are just a few of many reasons you should consider Maximum Controls



GEARBOX

The Megatron 2200 HP PRO implements a size 80, 900 to 1, dual gear reduction, high efficiency cast iron gearbox.

The Megatron 2200 HP PRO gearbox is highly efficient, producing maximum torque, maintaining a low amperage draw by reducing resistance, providing super silent operation. The rugged cast iron housing, bronze gears, and double sealed heat-treated solid shafts have been designed by a team with over 40 years of experience in the gearbox industry.

High speed ball bearings and a synthetic oil bath keep the dual gear reduction operating flawlessly through extreme temperature ranges without need for belts, chains, or pulleys which are subject to wear, raising maintenance issues.

We invite you to compare our Maximum Controls gearboxes to any of those used by other manufacturers.

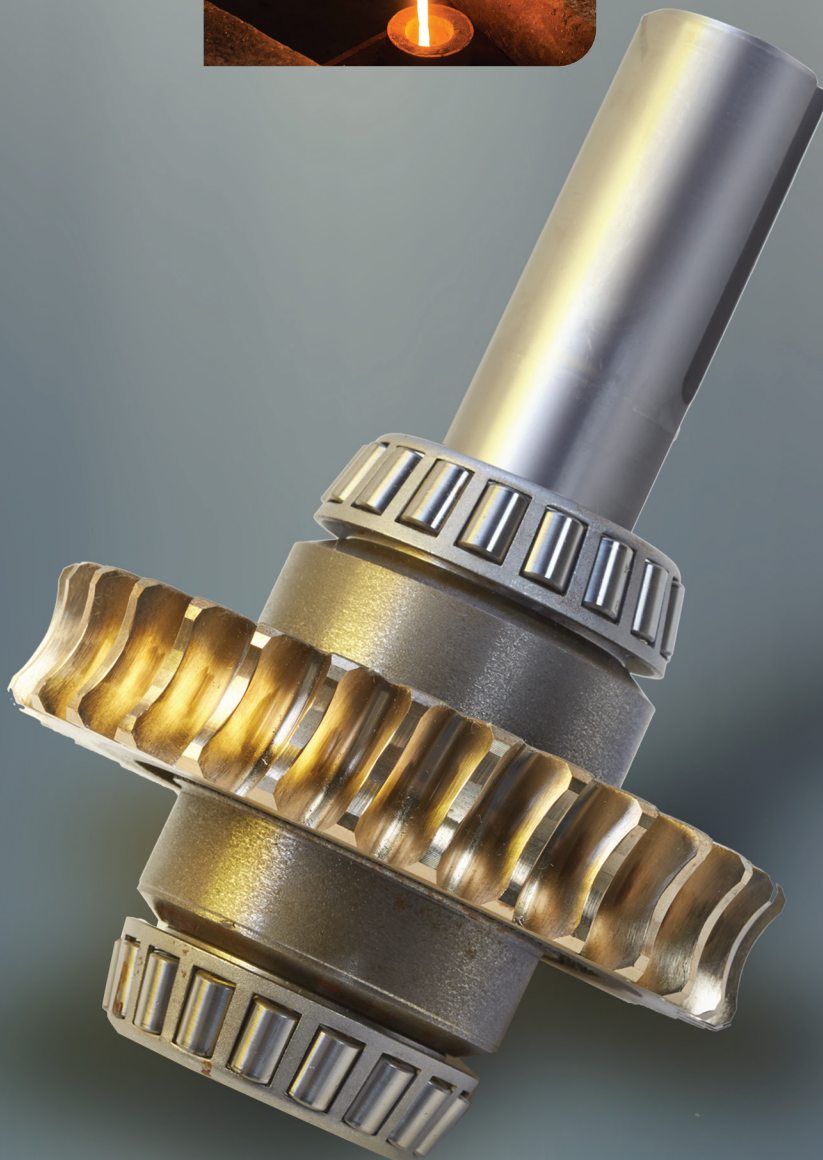

BRUSHLESS DC MOTOR

The brushless DC motor in the Megatron 2200 HP PRO uses "Hall Effect" magnetic sensing to identify over five thousand precise rotational positions during 90 degrees of gate movement. That's over 50 samples per degree of gate travel. Using this positional feedback, intelligent ramp-up and ramp-down of the gate speed is employed to minimize stress on all mechanical components.

We utilize Hall Effect sensors to know the position of the gate at any given moment thus synchronizing the gates to open and close at the same speed. We combine this technology with a dynamic magnetic brake system which stops the gate instantly when colliding with an obstacle.

Our brushless DC motors can withstand and operate in extreme high temperatures up to 165F (+74C); this surpasses any other motor technology we know of in the market today.

The Max brushless DC motor's torque is equivalent to a 1 1/4 HP AC output torque motor and can operate approximately 35,000 hours, which is about 6 million cycles. Therefore, the motor will last for decades to come. Maximum Controls stands behind our motors with a 5 year warranty.

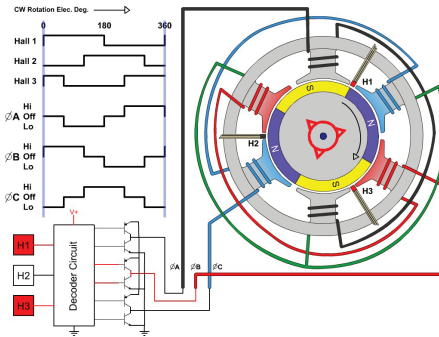

Brushless motors controlled by DSP is the same motor technology used in advanced robotics for automobile assembly.

MOTOR CONTROL TECHNOLOGY

Maximum Controls' brushless dc motor control enables precision movement that traditional brushed motors can not replicate. For example, no overcoasting. This ability is crucial in bi-parting slide gates on the same track, as well as catch posts or columns that can't be avoided.

Another advantage of precise gate control is the ability to stop instantly. In an emergency situation, this is critical. When a safety edge is struck, stopping on a dime to reduce risk of injury or damage to equipment is imperative. Our motor control technology is absolutely the most advanced on the market.

ADVANTAGES OF BRUSHLESS DC MOTOR

FEATURE	BRUSHED DC MOTORS	BRUSHLESS DC MOTOR MAX
Commutation	Mechanical	Electrical
Maintenance	High	Very Low
Electronic Noise EMI	High	Super Low
Life	Short	Much Longer 6,000,000 Cycles
Speed/Torque Characteristics	Moderately Flat	Flat (Enables Operation at All Speeds)
Efficiency	Medium	High
Motor Speed	Limited Speed Control	Variable Speed Control
Audible Noise	High at High Speeds Because of Brushes	Super Quiet
Drive Complexity	Inexpensive	Advanced DSP Control
Loss of Torque Due to Aging	Yes	No
Energy Consumption	Higher	Lower
Magnetic Hall Sensors	No	Yes (50 samples per degree of gate travel)

POWER SUPPLY

The Megatron 2200 HP PRO's power supply utilizes a 15 Amp torroid and power management board. The maximum Amp draw from the Megatron is 3.5 - 4.5 Amps depending on gate weight. The power supply is efficiently designed with ample headroom and is not overstressed under any extreme load or temperature conditions. The power supply input accepts 115V or 230V AC via selection switch. During gate operation the battery is not utilized while AC is present, preserving the life of the battery.

Input AC Power/Amps -

Switchable: 115VAC / 6 Amp, Single Phase
or 230VAC / 2 Amp, Single Phase

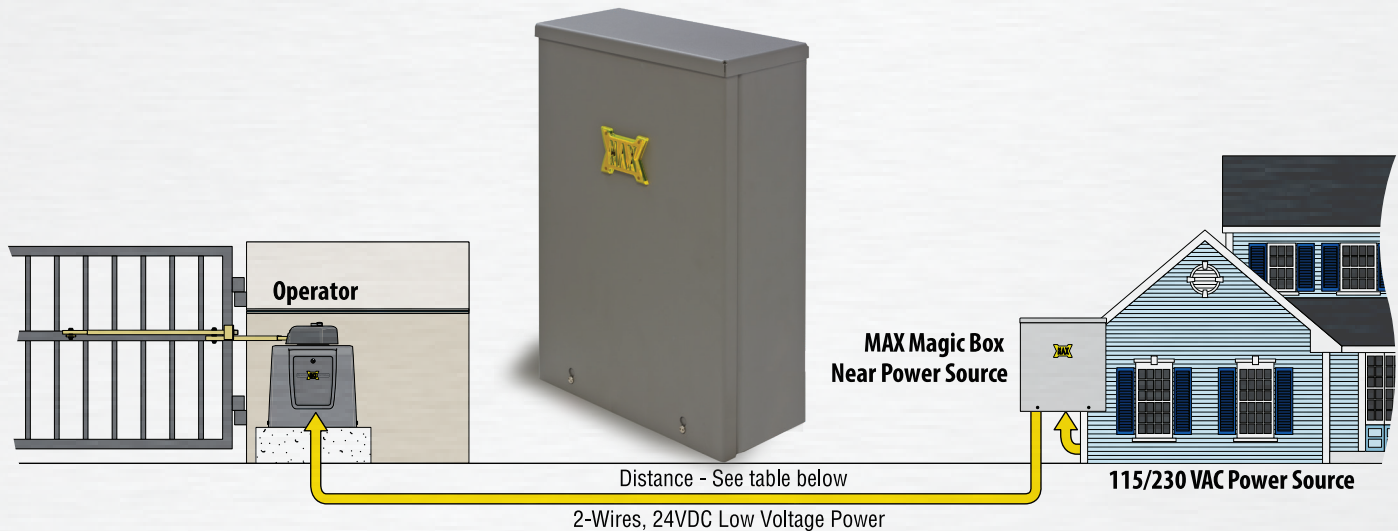

MAGIC BOX

The Megatron 2200 HP PRO MAGIC BOX feature can save thousands of dollars in trenching and costly permit fees. Unforeseen complications like rock formations or utility lines that have to be trenched around can be avoided by using the Magic Box. This feature is a power management system that does not rely on battery power and as a result the battery life is not compromised.

Because the Magic Box does not rely on the batteries as a booster, the gate remains operational regardless of whether the batteries are malfunctioning or the batteries are removed. This technology is unique only to Maximum Controls.

BLACK BOX, LOOP MANAGEMENT & SECURITY

One of the primary goals of the Megatron 2200 HP PRO is to provide the most secure, easiest to maintain gate operator with higher gate speed motion and advanced loop management.

The Megatron 2200 HP PRO uses non-volatile memory to continuously log performance characteristics and input/output events. A service technician can access this data via USB port to download the event history, quickly diagnosing complex or intermittent problems that traditionally have been very difficult to isolate and repair. By plugging a USB thumb drive into the USB port, all the Megatron's diagnostic history will download, working as a "Black Box" to diagnose what occurred. The Megatron's event history is stored as a .TXT document which can be emailed to the factory if necessary, for on-site diagnosis. The .TXT file is a log of the most recent 1000 events reported by each module to the central logger.

The Megatron 2200 HP PRO's standard intuitive loop management system, when enabled, will discourage tailgating, increasing security for residential and High-traffic installations. When the anti-tailgate switch is activated, any car tailgating a legitimate access will be forced to stop by a rapidly closing gate, forcing the tailgater to back up and thereby triggering the gate to close and deny unauthorized access.

When disabled, loop management will allow multi-access, with the gate opening on each successive trigger in the traditional loop management manner.

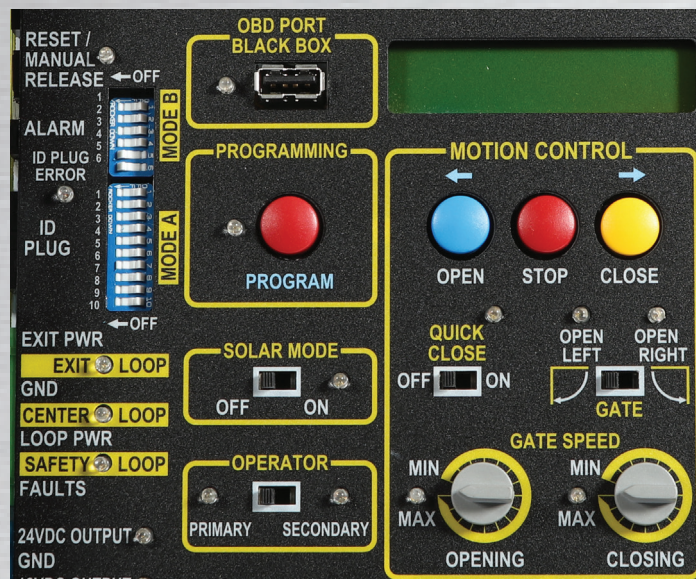

ADVANCED SECURITY FEATURES

Anti-Vandalism/Burglar Alarm

As a security device, the Megatron 2200 HP PRO supplies a gate tamper relay output that triggers whenever a gate has encountered an unauthorized movement. This can be configured to activate an alarm system or camera. The Megatron 2200 HP PRO also has a gate disable feature which can disable operator open commands during a vacation or overnight for commercial applications.

CONTROL FEATURES AND CONNECTIONS

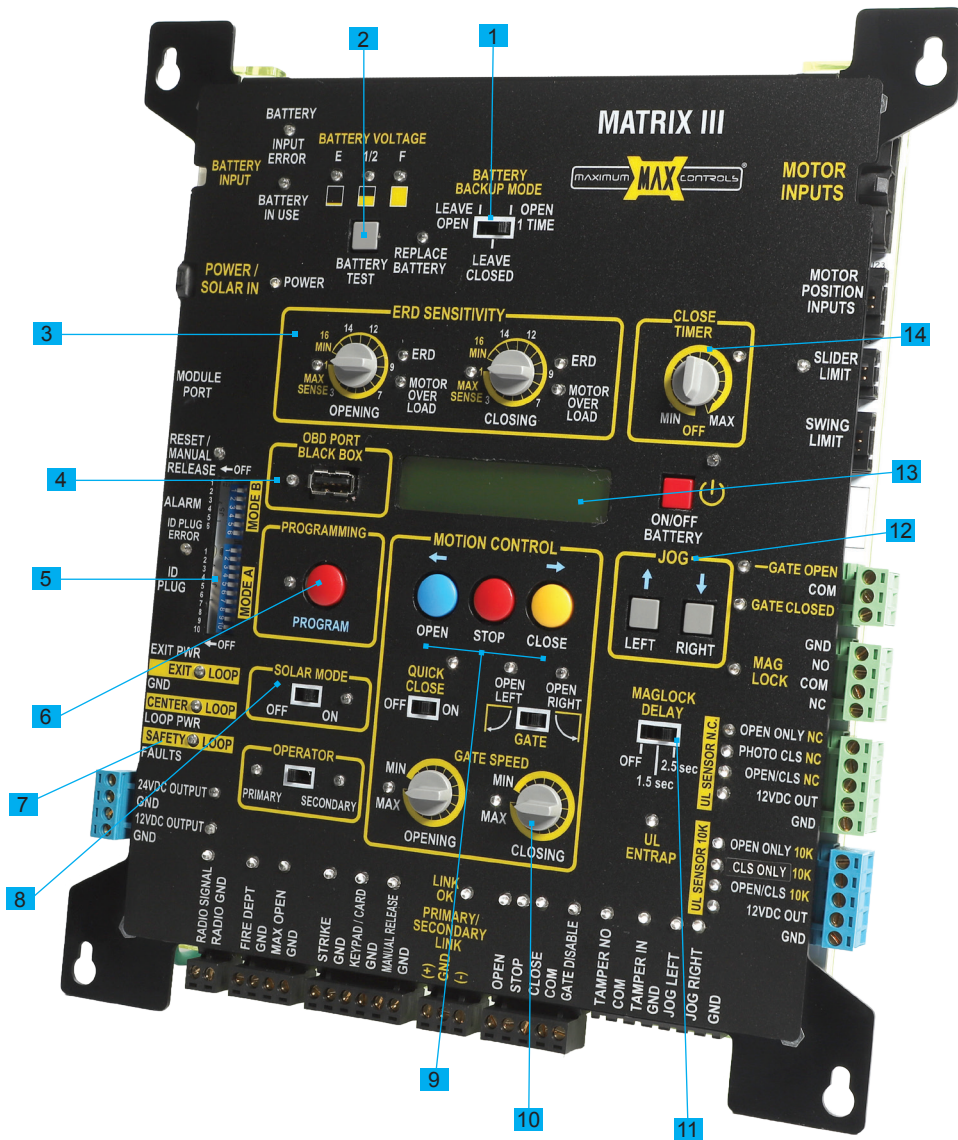

1. Battery backup mode switch
2. Battery test switch
3. ERD Sensitivity
4. OBD Port
5. DIP Switches
6. Program Button
7. Loop Status
8. Solar Mode Application
9. Motion Control Buttons
10. Closing gate speed
11. Maglock Delay
12. Jog Open/Close
13. LCD Display
14. Close Timer Switch

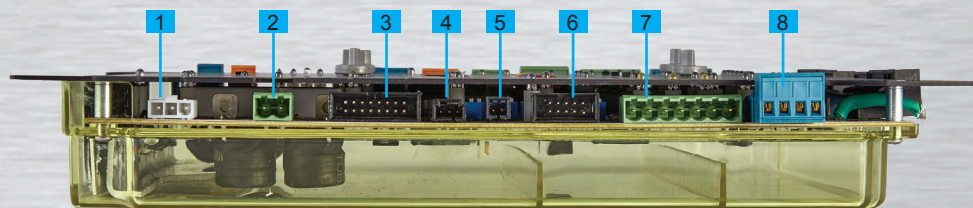

- | | |
|----------------------|---|
| 1. Battery Input | 5. UL Alarm |
| 2. Power/Solar Input | 6. ID Plug |
| 3. Module Port | 7. Loop Rack Input |
| 4. Reset | 8. 12vdc & 24vdc limited current power output |

LIGHTNING PROTECTION



The Megatron 2200 HP PRO offers the most robust lightning protection available in the industry. The Megatron 2200 HP PRO protects all peripheral inputs, loop inputs, power inputs, relay outputs, and all communication lines (over 44 channels of protection) in 1/1,000,000,000 of a second. With special emphasis on power supply protection, the Megatron 2200 HP PRO is guaranteed to withstand any lightning hit more than 50 feet away. Truly protected like no other operator in the world.

Maximum Controls LLC Warranty and Return Policy Megatron 2200 HP PRO

Section I Coverage

- a. 5-Year on all components.
- b. 1 year on batteries.

Section II Not Covered

- a. Damages due to vehicular strike.
- b. Damages due to water or liquid.
- c. Damages due to fire.
- d. Damages due to direct lightning.
- e. Damages due to extreme high wind.
- f. Damages due to vandalism.
- g. Damages due to negligence, i.e. leaving the cover off in the rain, improper wiring of AC or peripheral systems.
- h. Damages due to product misuse, i.e. gate and operator combination mismatch, i.e. heavy gate paired with low capacity gate operator.
- i. Damages due to unauthorized product modification or attempted repair.

Section III RMA Shipping Policy

- a. Maximum Controls LLC will pay for return shipping via standard ground UPS or USPS FOB CA on all RMA's within one year of Distributor's purchase.
- b. Any form of "Expedited Shipping" on any RMA will be paid by Distributor.

Section IV Product Returns

- a. Products must be in original, resellable condition with all warranty information, manuals, and original packaging.
- b. A re-stock fee of 10% will be charged on all returned products.
- c. All returned products must reference a Maximum Controls RMA number or it will be refused.
- d. Maximum Controls is not responsible for freight charges associated with returned merchandise.

NOTE: Products purchased online from unauthorized distributors will not be covered by our warranty.



