

Installation/Owner's Manual

Model 9050

Vehicular Slide Gate Operator

Use this manual for circuit board 4702-018 Revision A or higher.

9050-065-T-11-25

Entrapment Protection must be provided for the gate system where the risk of entrapment or obstruction exists. The operator will NOT run without one or more monitored type B1 or B2 entrapment protection devices in EACH direction of gate travel.

UL 325 August 2018 Standard

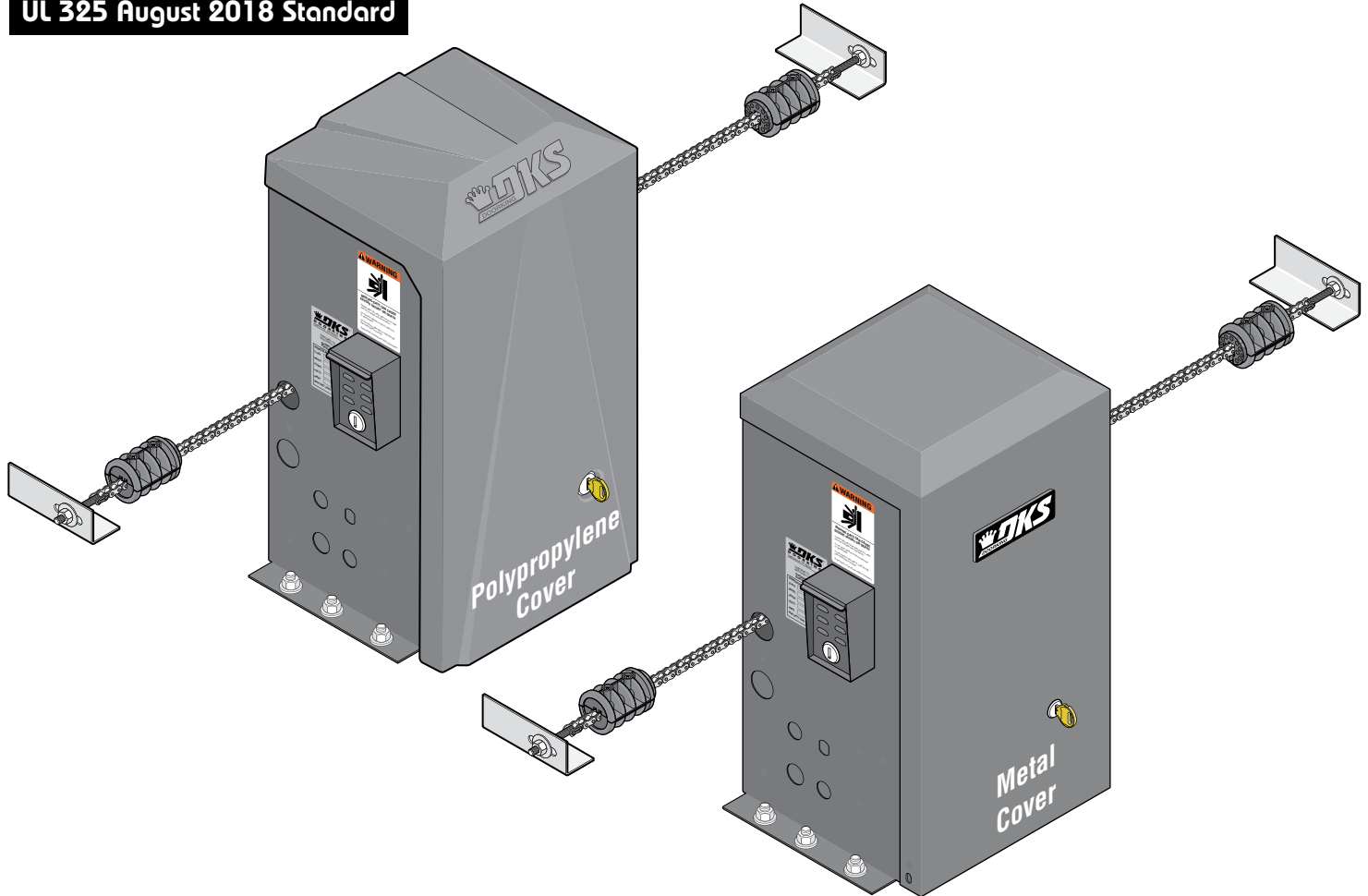

THIS PRODUCT IS TO BE INSTALLED AND SERVICED BY A TRAINED GATE/DOOR SYSTEMS TECHNICIAN ONLY.
Visit www.doorking.com/dealer-locator to find a professional installing and servicing dealer in your area.

Installer: Leave manual with property owner.

Date Installed: _____

Installer/Company Name: _____

Phone Number: _____

Circuit Board
Serial Number
and Revision Letter: _____

Property Owner: Checklist in back of manual to review and verify new installation with Installer.

Copyright 2025 DoorKing®, Inc. All rights reserved.



Listed to ANSI/CAN/UL 325



QUICK GUIDE: DIP-Switches

⚠ Every time the operator is powered up, the First open command will automatically run "Multiple gate cycles" that will locate and remember the gate's open and close positions (See page 20).

Whenever a switch setting is changed, power MUST be cycled to the operator.

Switch	Function	Setting	Description
1	Changes the direction the operator will open/close the gate depending on the different chain configurations.		
2	Auto-Close Timer	OFF	Auto-close timer is OFF. Manual input required to close gate.
		ON	Auto-close timer is ON. Adjustable from 1-23 seconds to close gate.
3	Spare	OFF	Leave on OFF setting.
4	Built-In Solenoid Lock See Page 32-33	OFF	Normal Setting. Fail-Safe (Factory Set). Lock engages only when an attempt is made to manually force the gate open.
		ON	Fail-Secure. Lock engages after each cycle. CAUTION: Do not use this setting unless the 2600-862 manual release kit has been installed or damage will occur to operator.
5 and 6	Gate Open Back-Off Position	5-OFF 6-OFF	Normal Setting. Gate fully opens.
		5-OFF 6-ON	Gate stops short 1" from full open position. Used for a reversing edge device.
		5-ON 6-OFF	Gate stops short 2" from full open position. Used for a reversing edge device.
		5-ON 6-ON	Gate stops short 3" from full open position. Used for a reversing edge device.
7 and 8	Gate Close Back-Off Position	7-OFF 8-OFF	Normal Setting. Gate fully closes.
		7-OFF 8-ON	Gate stops short 1" from full close position. Used for a reversing edge device.
		7-ON 8-OFF	Gate stops short 2" from full close position. Used for a reversing edge device.
		7-ON 8-ON	Gate stops short 3" from full close position. Used for a reversing edge device.

Switch 1 Must OPEN the gate upon initial AC power up and open command. If the first open command begins to close the gate, turn AC power off and reverse this switch. Opening direction will vary depending on the chain setup position (See above).

Switch 2 Turns the auto-close timer on or off. Can be adjusted from 1 to 23 seconds to close gate.

Switch 3 Leave switch in **OFF** position.

Switch 4 This switch determines the operation of the built-in solenoid lock. The OFF setting is the factory setup. **Caution: Do not set this switch to ON unless the 2600-862 fail-secure manual release kit has been installed in the operator.** Changing this switch to the ON setting without installing the lock kit will damage the operator. See pages 32 and 33 for more information about Fail-Safe vs. Fail-Secure release systems.

Switches 5-6 These work in conjunction with each other and determine if the operator will stop the gate at the full open position, or if the gate should stop 1, 2 or 3 inches short of the full open position. Needed only when using a reversing edge entrapment protection device on the **opening** edge of the gate with an end post as the physical stop.

Switches 7-8 These work in conjunction with each other and determine if the operator will stop the gate at the full close position, or if the gate should stop 1, 2 or 3 inches short of the full close position. Needed only when using a reversing edge entrapment protection device on the **closing** edge of the gate with an end post as the physical stop.

See page 28 for terminal wiring.

QUICK GUIDE: Terminal Descriptions

- When gate is closed, this input will open gate to full position.
- When gate is open and auto close timer Switch 2 is turned **ON**, input will re-set and hold timer.
- When gate is open and auto close timer Switch 2 is turned **OFF**, input will close gate.
- When gate is closing, input will reverse gate.



- This input **ONLY** functions when gate is **fully open** or in the **closing cycle**.
- When gate is open and auto close timer Switch 2 is turned **ON**, input will re-set and hold timer.
- When gate is open and auto close timer Switch 2 is turned **OFF**, input will prevent gate from closing.
- When gate is closing, input will reverse gate.



Relay activates **ONLY** when gate is in the **FULL open** position.

Relay contacts can be set for Normally Open (NO) or Normally Closed (NC) operation.
Contact rating is 1 amp maximum at 24-volts DC.

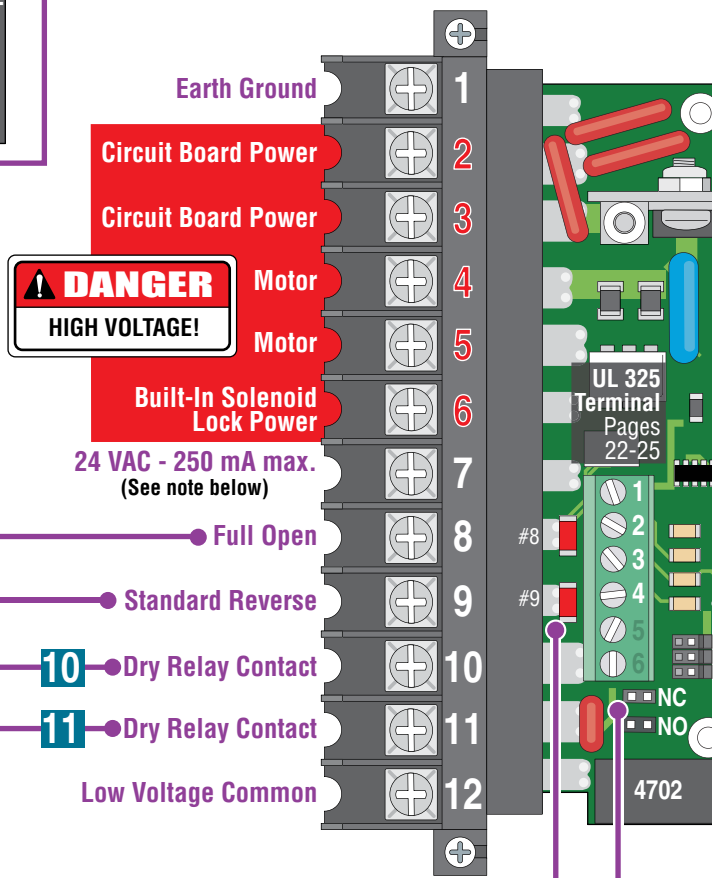
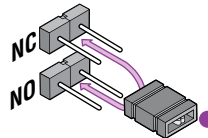

Main Terminal Input LEDs Note:
The LED that is beside the main terminal #8 and #9 wiring input will light when that terminal input gets activated.

Terminal #7 Note:
Exceeding 250 mA of power from this terminal may cause the circuit board transformer to overheat, causing intermittent problems. Use this to power the radio receiver **ONLY**.

9050 OPERATOR SPECIFICATIONS

Class of Operation	UL 325 Class I
Type of Gate	Vehicular Slide Gates Only
Horsepower	1/2 HP
Voltage / Phase	115 VAC Single-Phase
Current	5.4 Amps @ 120V
Max Gate Weight (Installed level)	700 Lbs.
Max Gate Length (Installed level)	20 Ft.
Drive Sprocket Size	#40 Chain
Cycles Per Hour	20 Per Hour
Speed	Approximately 1 Ft. per Second
Inherent Entrapment Protection Device	Inherent Reverse Sensor System (Type A)
External Entrapment Protection Device Inputs (Monitored Inputs)	Connection inputs for Non-contact Sensor - Photo Sensor (Type B1) Connection input for Contact Sensor - Reversing Edge (Type B2)

Use this manual for the Model 9050 operator with circuit board 4702-018 Rev A or higher ONLY.

Model #	Cover Type
9050-380	Metal
9050-385	Polypropylene

Polypropylene Cover Note: Allows wireless signal through cover.

Entrapment Protection must be provided for the gate system where the risk of entrapment or obstruction exists. The operator will NOT run without one or more monitored type B1 or B2 external entrapment protection devices in EACH direction of gate travel (minimum of 2 external devices required).

Type of wiring to be used on ALL external devices:

- A) Type CL2, CL2P, CL2R, or CL2X.
- B) Other cable with equivalent or better electrical, mechanical, and flammability ratings.

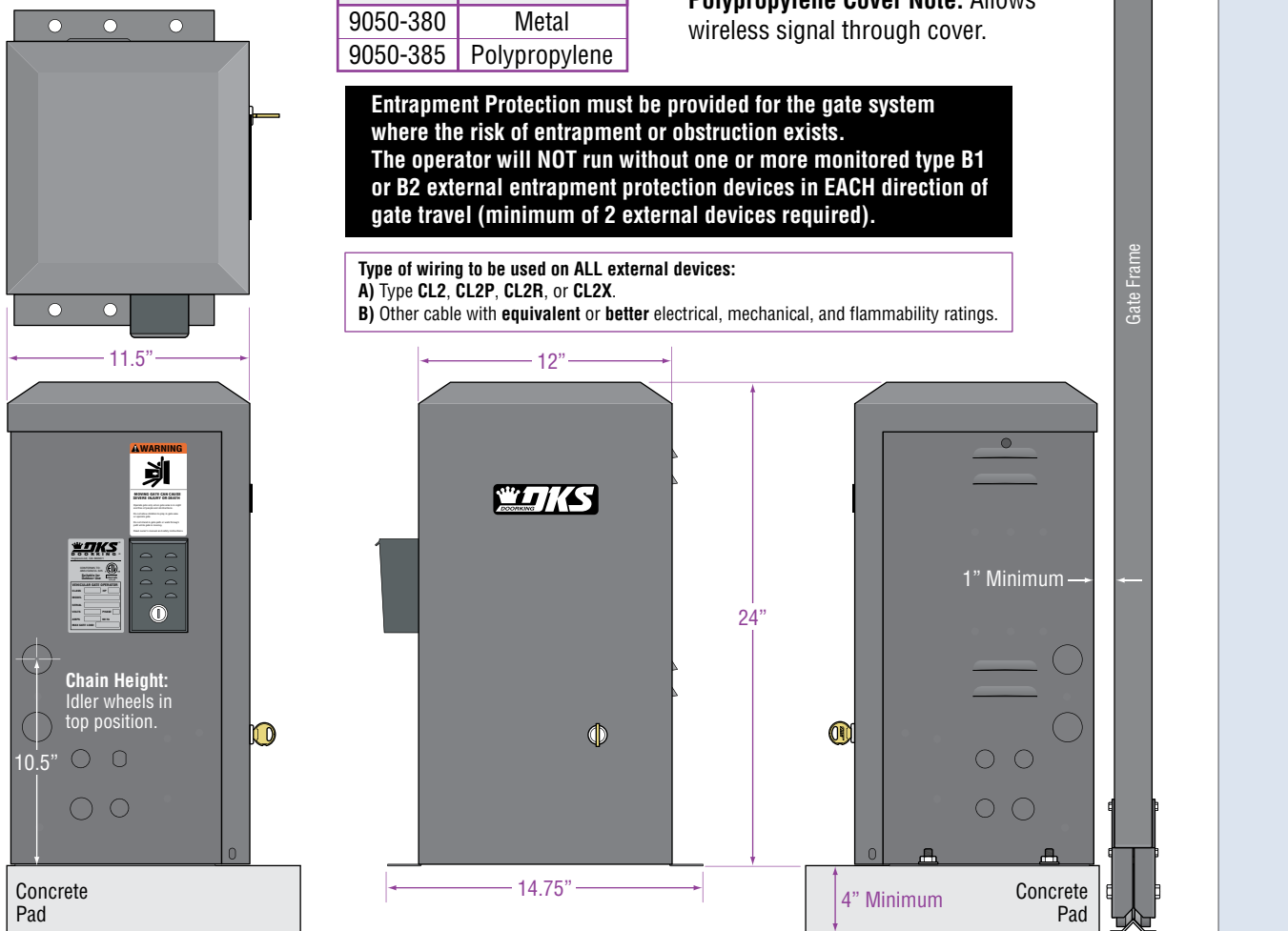

DoorKing, Inc. reserves the right to make changes in the products described in this manual without notice and without obligation of DoorKing, Inc. to notify any persons of any such revisions or changes. Additionally, DoorKing, Inc. makes no representations or warranties with respect to this manual. This manual is copyrighted, all rights reserved. No portion of this manual may be copied, reproduced, translated, or reduced to any electronic medium without prior written consent from DoorKing, Inc.

TABLE OF CONTENTS

QUICK GUIDES

Quick Guide: DIP-Switches	Quick Guide-1
Quick Guide: Terminal Descriptions	Quick Guide-2
9050 Operator Specifications	Previous Page
Slide Gate Requirements	2
Safety Information for Slide Gate Operators	3
ASTM 2200 Standard for Gate Construction	4
Important Safety Instructions	4
Instructions regarding intended installation:	4
Important Notices	5
UL325 Entrapment Protection	6
Glossary	7

SECTION 1 - INSTALLATION 8

1.1	Hardware for the Gate	8
1.2	Physical Stops for the Gate	8
1.3	Types of Gates	9
1.4	Operator Mounting Positions	10-13
1.5	Underground Conduit Requirements	13
1.6	Pad, Post or Ceiling Mount without / with J-Box Setup	14
1.7	Mounting Operator and Chain	15-16
1.8	Installation of Warning Signs	16

SECTION 2 - AC POWER TO OPERATOR(S) 17

2.1	High Voltage Wire Runs	17
2.2	High Voltage Terminal Connection	17

SECTION 3 - ADJUSTMENTS 18

3.1	4702 Circuit Board Description and Adjustments	18
3.2	DIP-Switch Settings	19
3.3	Automatic Open / Close Limit Adjustment	20
3.4	Clutch Adjustment	21
3.5	Inherent Reverse Sensor Adjustment	21

SECTION 4 - ENTRAPMENT AND SAFETY PROTECTION 22

4.1	UL 325 Terminal Description	22
4.2	Entrapment Protection Device Locations	23-24
4.3	Dual Gates Multiple Reversing Edges Wiring Sample	25
4.4	Loop Detector Wiring	26

SECTION 5 - WIRING 27

5.1	Main Terminal Description	27
5.2	Control Wiring for Single/Primary Operator	28
5.3	Bi-Parting Gates Wiring - Dual Gate Operators	29

SECTION 6 - OPERATING INSTRUCTIONS 30

6.1	AC Power and Reset Switch	30
6.2	Shutdown Conditions	31-32
6.3	Manual Gate Operation	32-33

SECTION 7 - MAINTENANCE AND TROUBLESHOOTING 34

7.1	Maintenance	34
7.2	Troubleshooting	35-36
7.3	Accessory Items	37
	Model 9050 Wiring Diagram	38

SECTION 8 - OWNER OF THE GATE OPERATOR 39

8.1	Alarm Sounding OR "Chirping" and Gate WILL NOT Operate	39
8.2	Manual Gate Operation	40
8.3	Gate Operators Monthly Checkup	41
8.4	New Installation Checklist for Installer and Property Owner	42
	Printable Safety Page	43

Slide Gate Requirements

The operator is intended for installation only on gates used for vehicles. Pedestrians must be supplied with a separate access opening. The pedestrian access opening shall be designed to promote pedestrian usage. Locate the gate such that persons will not come in contact with the vehicular gate during the entire path of travel of the vehicular gate.

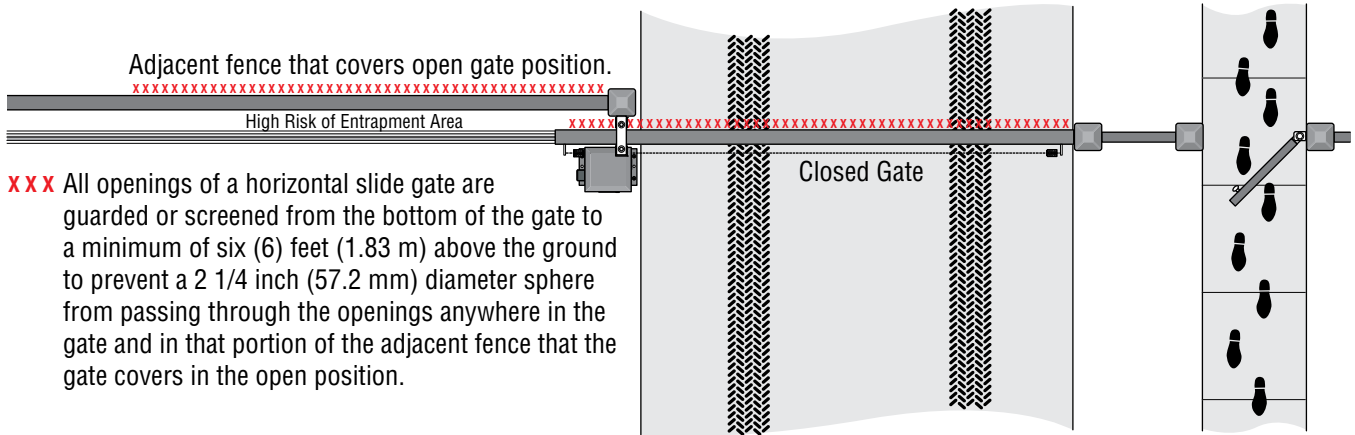

XXX All openings of a horizontal slide gate are guarded or screened from the bottom of the gate to a minimum of six (6) feet (1.83 m) above the ground to prevent a 2 1/4 inch (57.2 mm) diameter sphere from passing through the openings anywhere in the gate and in that portion of the adjacent fence that the gate covers in the open position.

Screened Wire Mesh Less than 2 1/4"

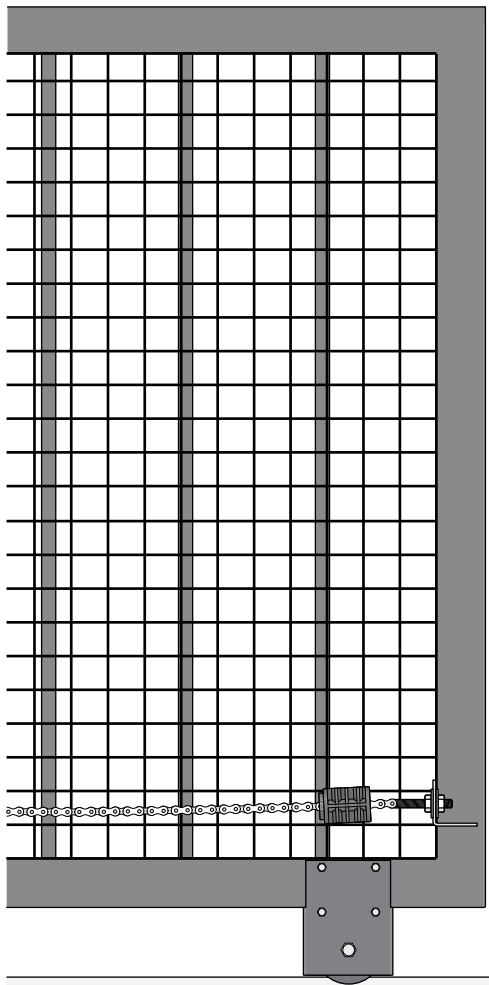

DoorKing recommends installing screened wire mesh on the **ENTIRE** gate **AND** on that portion of the adjacent fence that the gate covers in the open position. (See above).

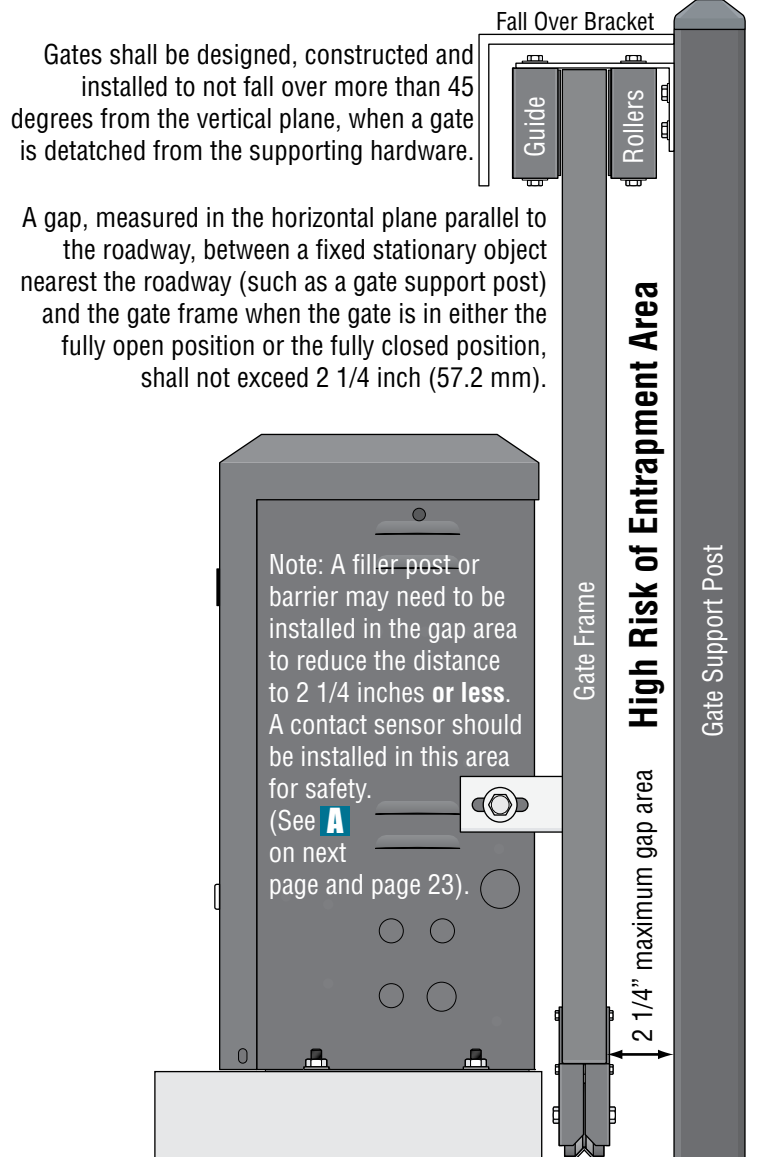

Safety Information for Slide Gate Operators

Illustration not to scale.

Entrapment protection devices are required to reduce the risk of injury. Install sensors where the risk of entrapment or obstruction exists while gate is moving. **Individual requirements will vary.** See pages 22-26 for more information on typical layout locations and setup.

Non-Contact Sensors (Photo Sensors)

- 1** Helps minimize the potential of entrapment during the closing cycle of the gate. Minimizes the potential of the gate closing on vehicular or other traffic that loops cannot sense. It can be installed on the secure **OR** non-secure side of gate.
- 2** Helps minimize the potential of entrapment during the back travel of the gate (opening cycle). See previous page for gate gap information.

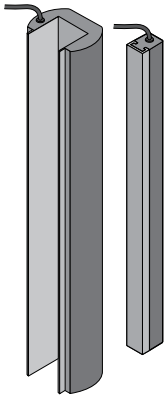

Contact Sensor (Reversing Edges)

- A** Installed on the fence to help minimize the potential of entrapment between the gate and fence during the opening cycle of the gate. A filler post or barrier **MAY** need to be installed between fence and gate.
- B** Helps minimize the potential of entrapment during the back travel of the gate (opening cycle).
- C** Helps minimize the potential of entrapment during the closing cycle of the gate. Minimizes the potential of the gate closing on vehicular or other traffic that loops cannot sense.

Guide Rollers

See previous page for more information.

Physical Stops

Positive stops shall be required to limit travel to the designed fully open and fully closed positions. These stops shall be installed either at the top of the gate, or at the bottom of the gate where such stops shall horizontally or vertically project no more than is required to perform their intended function.

Screened Wire Mesh

May be necessary on part of fence **AND** entire gate. See previous page for more information.

Warning Sign

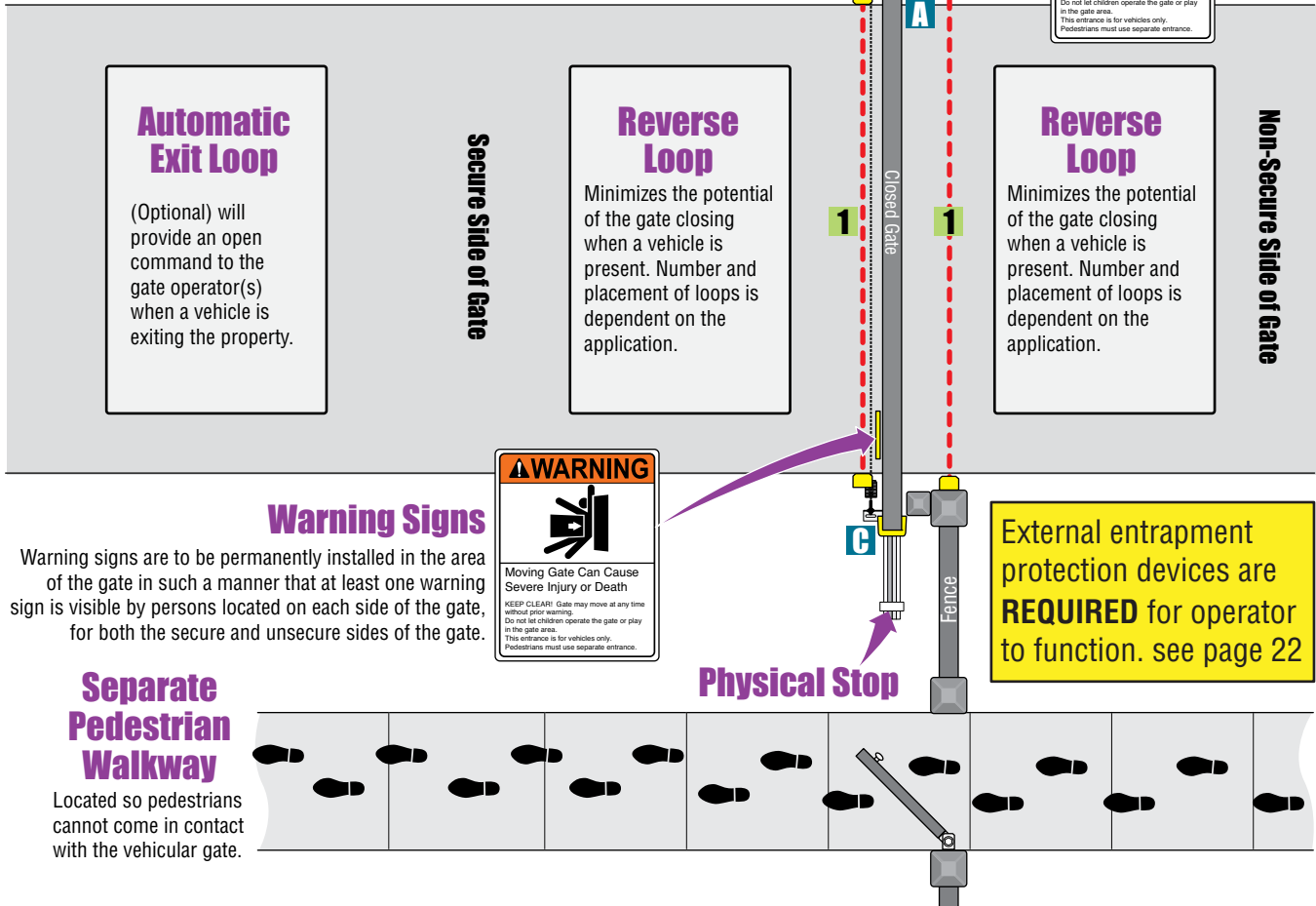

Automatic Exit Loop

(Optional) will provide an open command to the gate operator(s) when a vehicle is exiting the property.

Secure Side of Gate

Reverse Loop

Minimizes the potential of the gate closing when a vehicle is present. Number and placement of loops is dependent on the application.

Reverse Loop

Minimizes the potential of the gate closing when a vehicle is present. Number and placement of loops is dependent on the application.

Non-Secure Side of Gate

Warning Signs

Warning signs are to be permanently installed in the area of the gate in such a manner that at least one warning sign is visible by persons located on each side of the gate, for both the secure and unsecure sides of the gate.



Separate Pedestrian Walkway

Located so pedestrians cannot come in contact with the vehicular gate.

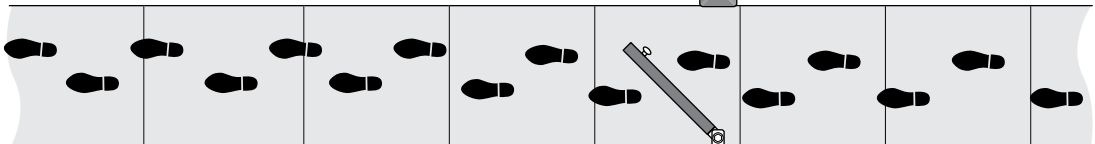

ASTM F2200 Standard for Gate Construction

Vehicular gates should be constructed and installed in accordance with ASTM F2200; Standard Specification for Automated Vehicular Gate Construction. For a copy of this standard, contact ASTM directly at 610-832-9585; service@astm.org; or www.astm.org.

Important Safety Instructions

WARNING - To reduce the risk of severe injury or death:

1. READ AND FOLLOW ALL INSTRUCTIONS.
2. Never let children operate or play with gate controls. Keep the remote control away from children.
3. Always keep people and objects away from gate. **NO ONE SHOULD CROSS THE PATH OF THE MOVING GATE.**
4. Test the operator monthly. The gate MUST reverse on contact with a rigid object or stop or reverse when an object activates the non-contact sensors. After adjusting the force or the limit of travel, retest the gate operator. Failure to adjust and retest the gate operator properly can increase the risk of severe injury or death.
5. Use the manual release only when the gate is not moving.
6. KEEP GATES PROPERLY MAINTAINED. Read the owner's manual. Have a qualified service person make repairs to gate hardware.
7. The operator is intended for installation on gates used for vehicles. Pedestrians must be supplied with a separate access opening. The pedestrian access opening shall be designed to promote pedestrian usage. Locate the gate such that persons will not come in contact with the vehicular gate during the entire path of travel of the vehicular gate.
8. **SAVE THESE INSTRUCTIONS!**

Instructions regarding intended installation:

- Install the gate operator only if:
 1. The operator is appropriate for the construction of the gate and the usage class of the gate.
 2. All openings of a horizontal slide gate are guarded or screened from the bottom of the gate to a minimum of 6 feet (1.83 m) above the ground to prevent a 2 ¼ inch (57.2 mm) diameter sphere from passing through the openings anywhere in the gate, and in that portion of the adjacent fence that the gate covers in the open position.
 3. All exposed pinch points are eliminated or guarded.
 4. Guarding is supplied for exposed rollers.
- The operator is intended for installation only on gates used for vehicles. Pedestrians must be supplied with a separate access opening. The pedestrian access opening shall be designed to promote pedestrian usage. Locate the gate such that persons will not come in contact with the vehicular gate during the entire path of travel of the vehicular gate.
- The gate must be installed in a location so that enough clearance is supplied between the gate and adjacent structures when opening and closing to reduce the risk of entrapment. Swinging gates should not open into public access areas.
- The gate must be properly installed and work freely in both directions prior to the installation of the gate operator. Do not over-tighten the operator clutch, pressure relief valve or reduce reversing sensitivity to compensate for a damaged gate.
- For gate operators utilizing Type D protection:
 1. The gate operator controls must be placed so that the user has full view of the gate area when the gate is moving.
 2. A warning placard shall be placed adjacent to the controls.
 3. An automatic closing device (such as a timer, loop sensor, or similar device) shall not be employed.
 4. No other activation device shall be connected.
- Controls intended for user activation must be located at least six feet (6') away from any moving part of the gate and where the user is prevented from reaching over, under, around or through the gate to operate the controls. Outdoor or easily accessible controls should have a security feature to prevent unauthorized use.
- The Stop and/or Reset button must be located in the line-of-sight of the gate. Activation of the reset control shall not cause the operator to start.
- Warning signs are to be permanently installed in the area of the gate in such a manner that at least one warning sign is visible by persons located on each side of the gate, for both the secure and unsecure sides of the gate.
- For gate operators utilizing a non-contact sensor:
 1. See the instructions on the placement of non-contact sensors for each type of application.
 2. Care shall be exercised to reduce the risk of nuisance tripping, such as when a vehicle trips the sensor while the gate is still moving in the opening direction.
 3. One or more non-contact sensors shall be located where the risk of entrapment or obstruction exist, such as the perimeter reachable by a moving gate or barrier.
- For gate operators utilizing contact sensors:
 1. One or more contact sensors shall be located where the risk of entrapment or obstruction exist, such as at the leading edge, trailing edge, and post mounted both inside and outside of a vehicular horizontal slide gate.
 2. One or more contact sensors shall be located at the bottom edge of a vehicular vertical lift gate.
 3. One or more contact sensors shall be located at the pinch point of a vehicular vertical pivot gate.
 4. A hardwired contact sensor shall be located and its wiring arranged so that the communication between the sensor and the gate operator is not subjected to mechanical damage.
 5. A wireless contact sensor such as one that transmits radio frequency (RF) signals to the gate operator for entrapment protection functions shall be located where the transmission of the signals are not obstructed or impeded by building structures, natural landscaping or similar obstructions. A wireless contact sensor shall function under the intended end-use conditions.
 6. One or more contact sensors shall be located at the bottom edge of a vertical barrier (arm).
- Be sure you have instructed the owner of the gate operator about safe and proper operation and testing of the gate operator.

Important Notices

Vehicular gate operator products provide convenience and security. However, gate operators must use high levels of force to move gates and most people underestimate the power of these systems and do not realize the potential hazards associated with an incorrectly designed or installed system. These hazards may include:

- Pinch points
- Entrapment areas
- Reach through hazards
- Absence of entrapment protection devices
- Improperly located access controls
- Absence of vehicle protection devices
- Absence of controlled pedestrian access

In addition to these potential hazards, automated vehicular gate systems must be installed in accordance with the UL 325 Safety Standard and the ASTM F2200 Construction Standard. Most people are unaware of, or are not familiar with, these standards. If an automated vehicular gate system is not properly designed, installed, used and maintained, severe injuries or death can result. Be sure that the installer has instructed you on the proper operation of the gate and gate operator system.

Be sure that the installer has trained you on proper and safe operation of this gate operating system and about the basic functions of the required reversing systems associated with your gate operating system and how to test them (see section 8). These include reversing loops, inherent reversing system, electric edges, photoelectric cells, or other external devices.

- This Owner's Manual is your property. Keep it in a safe place for future reference.
- Be sure that all access control devices are installed a minimum distance of 6 feet away from the gate and gate operator, or in such a way that a person cannot touch the gate or gate operator while using the device. If access control devices are installed in violation of these restrictions, immediately remove the gate operator from service and contact your installing dealer.

Opening device MUST be mounted a minimum of 6 feet from the gate and NOT accessible through the gate!



- Loops and loop detectors, photo-cells or other equivalent devices must be installed to prevent the gate from closing on vehicular traffic.
- The speed limit for vehicular traffic through the gate area is 5 MPH. Install speed bumps and signs to keep vehicular traffic from speeding through the gate area. Failure to adhere to posted speed limits can result in damage to the gate, gate operator, and to the vehicle.
- Be sure that all persons who will use the gate system are familiar with the proper use of the gate and gate operator and are familiar with the possible hazards associated with the gate system.
- Warning signs are to be permanently installed in the area of the gate in such a manner that at least one warning sign is visible by persons located on each side of the gate, for both the secure and unsecure sides of the gate.
- It is your responsibility to periodically check all entrapment protection devices. If any of these devices are observed to function improperly, remove the operator from service immediately and contact your installing or servicing dealer.
- Follow the recommended maintenance schedule.
- Do not allow children to play in the area of the operator or to play with any gate-operating device.
- To remove the gate operator from service, operate the gate to the full open position and then shut off power to the operator at the service panel.

UL 325 Entrapment Protection

UL 325 Classifications



Class I - Residential Vehicular Gate Operator

A vehicular gate operator (or system) intended for use in garages or parking areas associated with a residence of one-to four single families.



Class III - Industrial/Limited Access Vehicular Gate Operator

A vehicular gate operator (or system) intended for use in an industrial location or building such as a factory or loading dock area or other locations not accessible by or intended to service the general public.

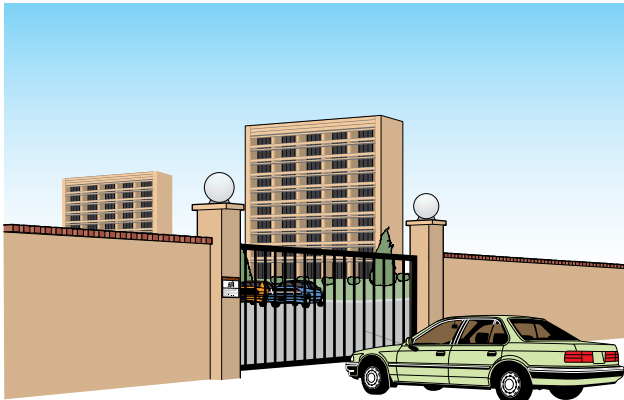

Class II - Commercial/General Access Vehicular Gate Operator

A vehicular gate operator (or system) intended for use in a commercial location or building such as a multi-family housing unit (five or more single family units), hotel, garages, retail store, or other buildings accessible by or servicing the general public.



Class IV - Restricted Access Vehicular Gate Operator

A vehicular gate operator (or system) intended for use in a guarded industrial location or building such as an airport security area or other restricted access locations not servicing the general public, in which unauthorized access is prevented via supervision by security personnel.

Gate Operator Category

	Horizontal Slide, Vertical Lift, Vertical Pivot, Horizontal Bifold	Swing, Vertical Barrier (Arm)
Entrapment Protection Types	A, B1*, B2* or D	A, B1*, B2*, C or D

Type A - Inherent entrapment protection system.

Type B1 - Non-contact sensor (photoelectric sensor or the equivalent).

Type B2 - Contact sensor (edge device or equivalent).

Type C - Inherent force limiting, inherent adjustable clutch or inherent pressure relief device.

Type D - Actuating device requiring constant pressure to maintain opening or closing motion of the gate.

* B1 and B2 means of entrapment protection must be MONITORED.

Vertical Barrier Note: Barrier gate operators (arm) that is not intended to move toward a rigid object closer than 16 inches (406 mm) are not required to be provided with a means of entrapment protection.

Glossary

GATE - A moving barrier such as a swinging, sliding, raising, lowering, folding, pivoting, or the like, barrier, that is a stand-alone passage barrier or is that portion of a wall or fence system that controls entrance and/or egress by persons or vehicles and completes the perimeter of a defined area.

RESIDENTIAL VEHICULAR GATE OPERATOR – CLASS I - A vehicular gate operator (or system) intended for use in a home of one-to four single family dwelling, or garage or parking area associated therewith.

COMMERCIAL / GENERAL ACCESS VEHICULAR GATE OPERATOR - CLASS II - A vehicular gate operator (or system) intended for use in a commercial location or building such as a multi-family housing unit (five or more single family units), hotels, garages, retail store, or other building servicing the general public.

INDUSTRIAL / LIMITED ACCESS VEHICULAR GATE OPERATOR - CLASS III - A vehicular gate operator (or system) intended for use in an industrial location or building such as a factory or loading dock area or other locations not intended to service the general public.

RESTRICTED ACCESS VEHICULAR GATE OPERATOR - CLASS IV - A vehicular gate operator (or system) intended for use in a guarded industrial location or building such as an airport security area or other restricted access locations not servicing the general public, in which unauthorized access is prevented via supervision by security personnel.

VEHICULAR BARRIER (ARM) OPERATOR (OR SYSTEM) - An operator (or system) that controls a cantilever type device (or system), consisting of a mechanical arm or barrier that moves in a vertical arc, intended for vehicular traffic flow at entrances or exits to areas such as parking garages, lots or toll areas.

VEHICULAR HORIZONTAL SLIDE-GATE OPERATOR (OR SYSTEM) - A vehicular gate operator (or system) that controls a gate which slides in a horizontal direction that is intended for use for vehicular entrance and exit to a drive, parking lot, or the like.

VEHICULAR SWING-GATE OPERATOR (OR SYSTEM) - A vehicular gate operator (or system) that controls a gate which moves in an arc in a horizontal plane that is intended for use for vehicular entrance and exit to a drive, parking lot, or the like.

SYSTEM - In the context of these requirements, a system refers to a group of interacting devices intended to perform a common function.

WIRED CONTROL - A control implemented in a form of fixed physical interconnections between the control, the associated devices, and an operator to perform predetermined functions in response to input signals.

WIRELESS CONTROL - A control implemented in means other than fixed physical interconnections (such as radio waves or infrared beams) between the control, the associated devices, and an operator to perform predetermined functions in response to input signals.

INHERENT ENTRAPMENT PROTECTION SYSTEM - A system, examples being a motor current or speed sensing system, which provides protection against entrapment upon sensing an object and is incorporated as a permanent and integral part of the operator.

EXTERNAL ENTRAPMENT PROTECTION DEVICE - A device, examples being an edge sensor, a photoelectric sensor, or similar entrapment protection device, which provides protection against entrapment when activated and is not incorporated as a permanent part of an operator.

ENTRAPMENT - The condition when a person is caught or held in a position that increases the risk of injury.

SECTION 1 - INSTALLATION

Prior to beginning the installation of the slide gate operator, we suggest that you become familiar with the instructions, illustrations, and wiring guide-lines in this manual. This will help insure that your installation is performed in an efficient and professional manner compliant with UL 325 safety and ASTM F2200 construction standards.

The proper installation of the vehicular slide gate operator is an extremely important and integral part of the overall access control system. *Check all local building ordinances and building codes prior to installing this operator. Be sure your installation is in compliance with local codes.*

1.1 Hardware for the Gate

Good hardware is essential for proper operation of a sliding gate. DoorKing has a full line of gate hardware products that will ensure safe, reliable and long lasting gate operation. The gate must be properly installed and roll smoothly in both directions.

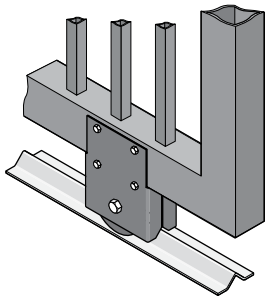

Roller Bearing V-Wheels with Protective Cover - Helps to minimize a pinch point on the gate's wheel and V-rail.

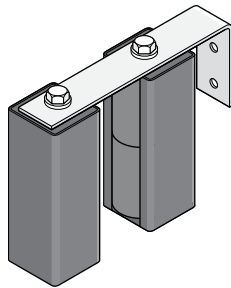

Guide Rollers with Protective Covers - Helps to minimize a pinch point on the gate.

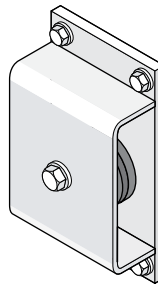

Endless Idler Assembly with Protective Cover - Helps to minimize a pinch point for a 180° chain return.

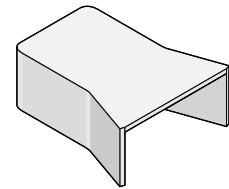

Gate End Retainer - Helps stabilize the end of the gate in the open or closed position. Recommended for all slide gate applications.

1.2 Physical Stops for the Gate

The 9050 automatic open/close gate limits **must have a physical stop on the open and close positions of the gate**. This can be the use of end posts with gate end retainers or chain stops, depending on the mounting position of the operator. Chain stops DO NOT meet the ASTM F2200 requirements.

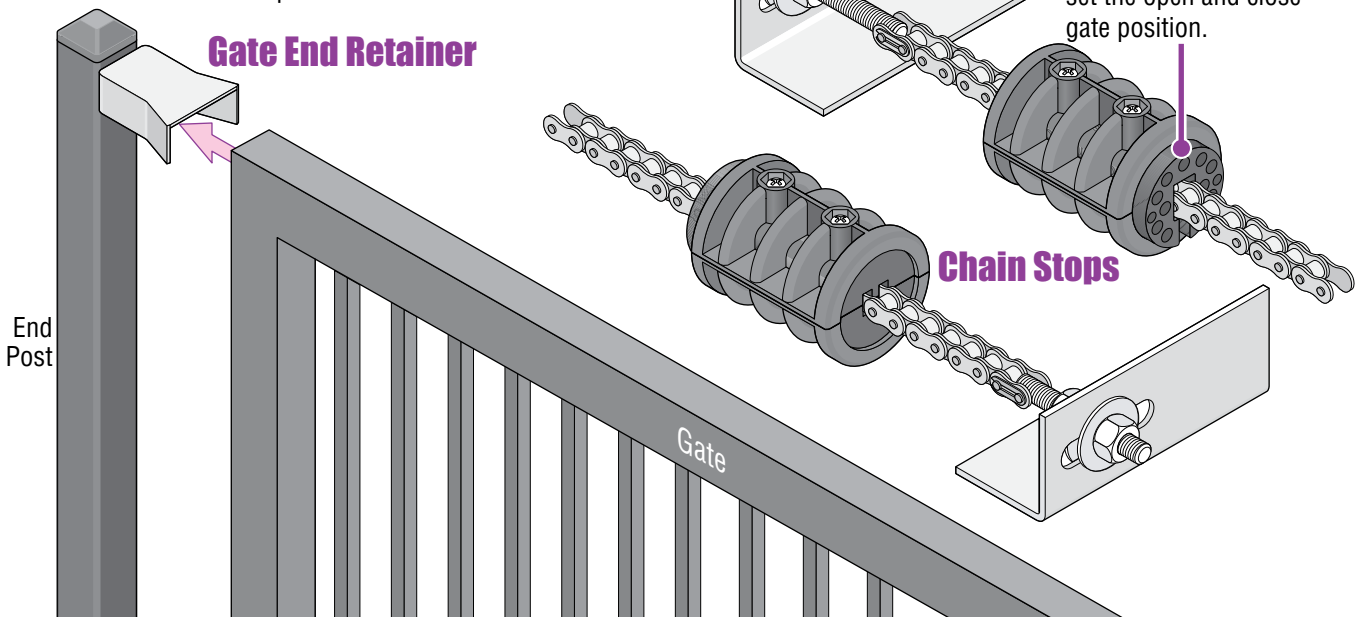

1.3 Typical Gate Types

The Model 9050 operator is designed to be installed on these gate types. See the next 4 pages for specific operator mounting positions. Individual installations and physical stops can vary.

- 700 lb max. weight per gate.
- Single Operator - 20 ft max. gate length.
- Dual Operators - 40 ft max. total gate length.

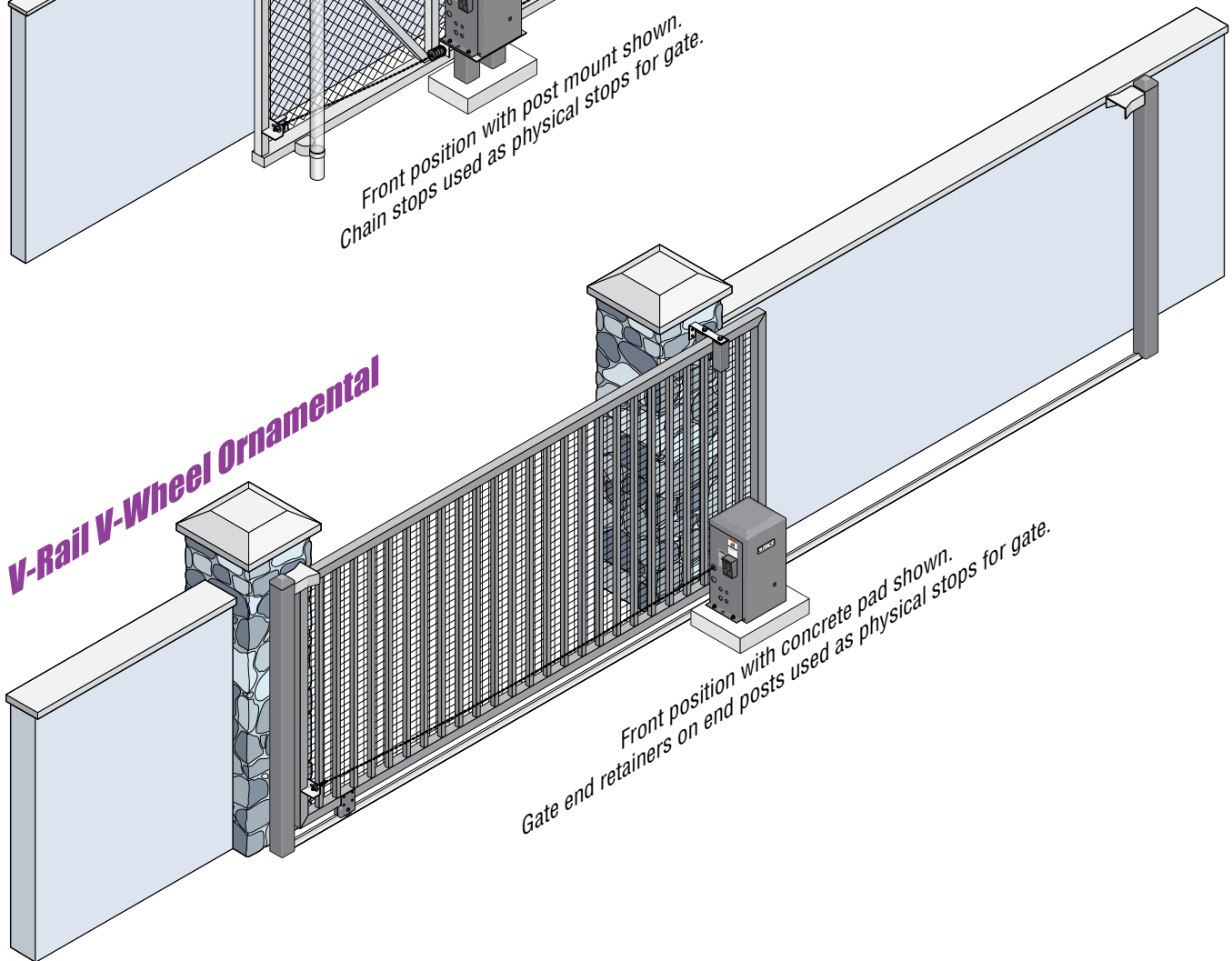
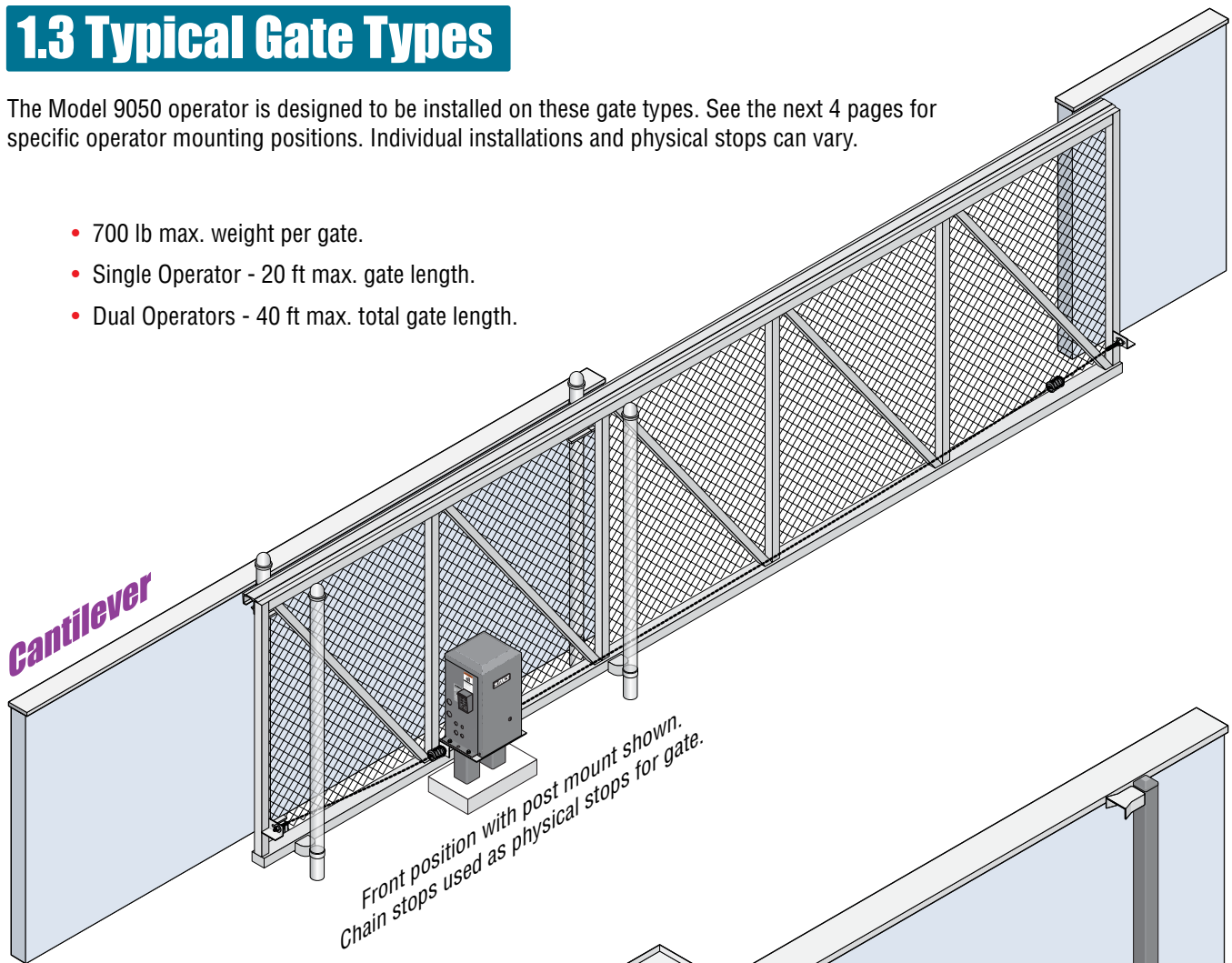

1.4 Operator Mounting Positions

The Model 9050 operator is designed to be installed in the front, rear, center or ceiling mounting positions shown on this page and the next 3 pages. V-wheel V-rail ornamental gates are shown as examples but other gate types on the previous page can use the same mounting setups. Once the mounting position has been determined, the chain idler wheels may need to be adjusted **BEFORE** the operator is mounted. **Physical stops MUST be used in the open AND close positions for ANY gate installation (Chain stops, end posts with gate end retainers or a wall that the gate comes in contact with).**

Front Position with Concrete Pad

Standard method of installation.

- Operator's chain idler wheels are factory set for the front position.
- Remove only the top chain knockouts from each side of the operator.
- Chain stops or gate end retainer can be used as the physical stop for the gate (Chain stops are shown).

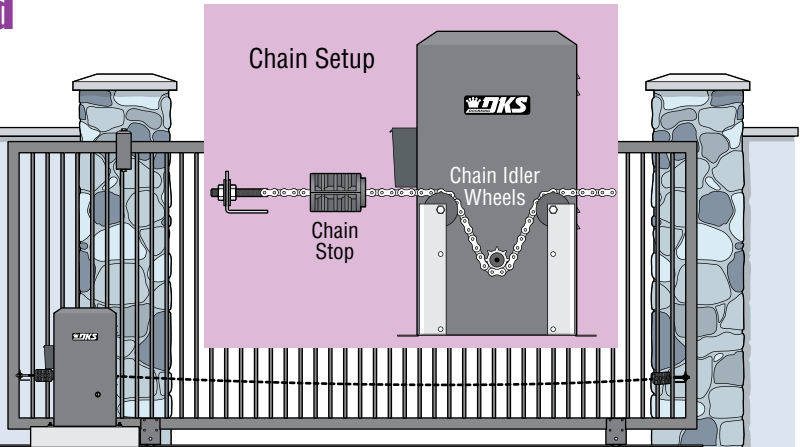

Top View

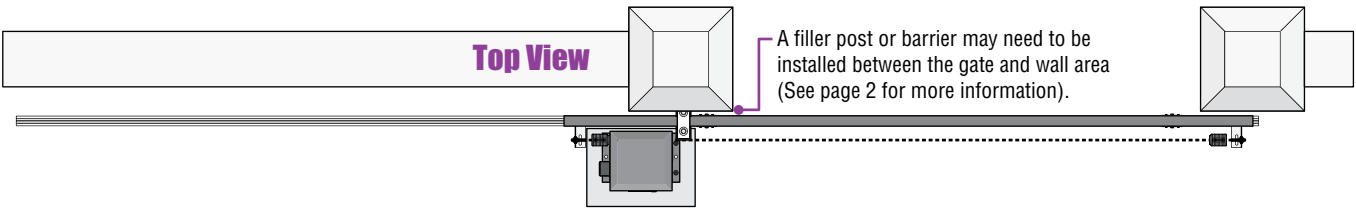

Front Position with Post Mount

Raises operator and allows different chain heights.

Gate End Retainer

- Set operator chain idler wheels in the bottom position.
- **DO NOT** remove chain knockouts.
- Chain stops with base plate stop brackets or gate end retainer can be used as the physical stop for the gate (Both are shown, only one type is needed).

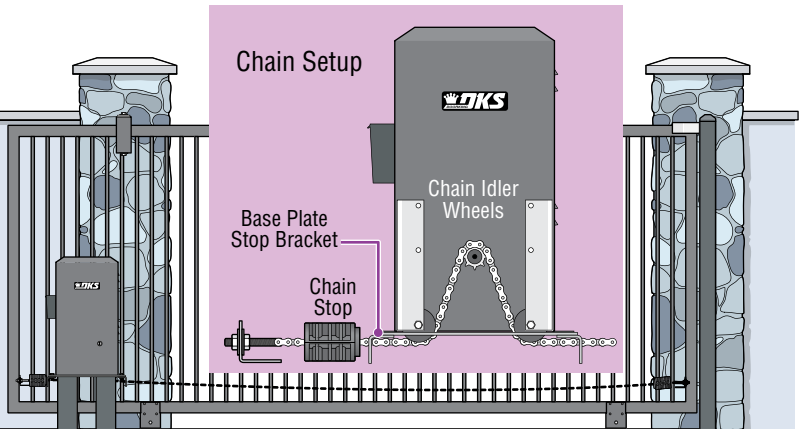

Top View

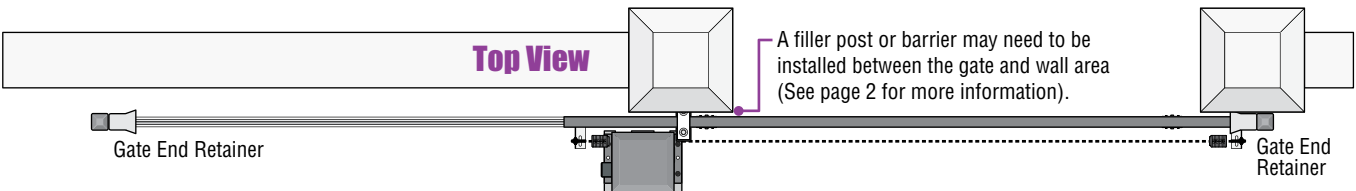

Additional hardware required. Post base plate (P/N 2600-418) 4 x 4 steel posts not available from DoorKing. Base plate stop brackets (P/N 2600-970) bolts on post base plate when using chain stops.

Rear Position with Concrete Pad

Hides the chain from outside the property looking in.

- Set one chain Idler wheel at the top and one in the center position on one side of the operator.
- Remove both chain knockouts from one side of the operator.
- Chain stops or gate end retainer can be used as the physical stop for the gate (Chain stops are shown).

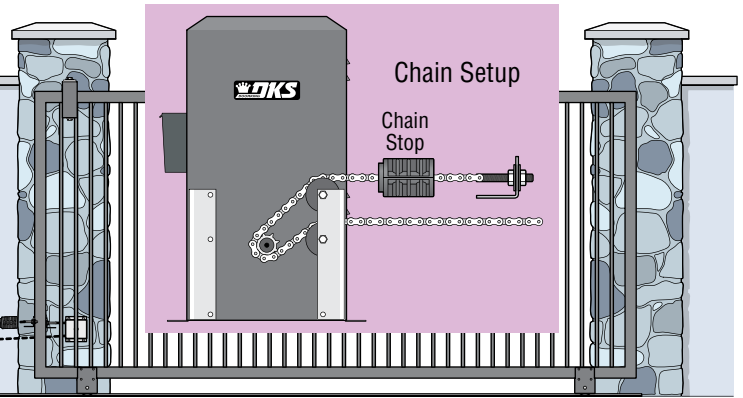
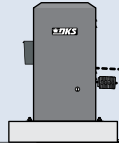

Additional hardware required. Endless idler assembly (P/N 2600-818) and additional chain #40 (P/N 2600-442 - 20 ft. per box) may be needed.

Top View

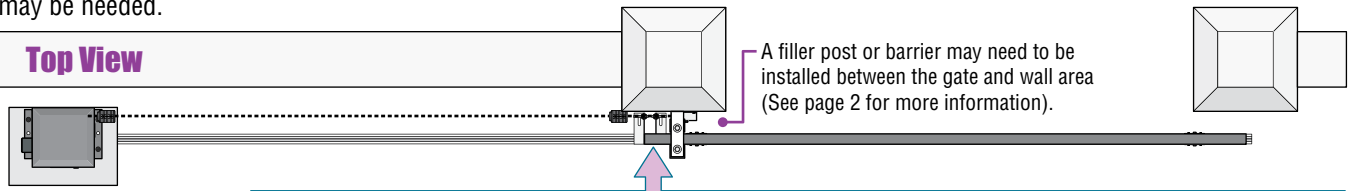

A filler post or barrier may need to be installed between the gate and wall area (See page 2 for more information).

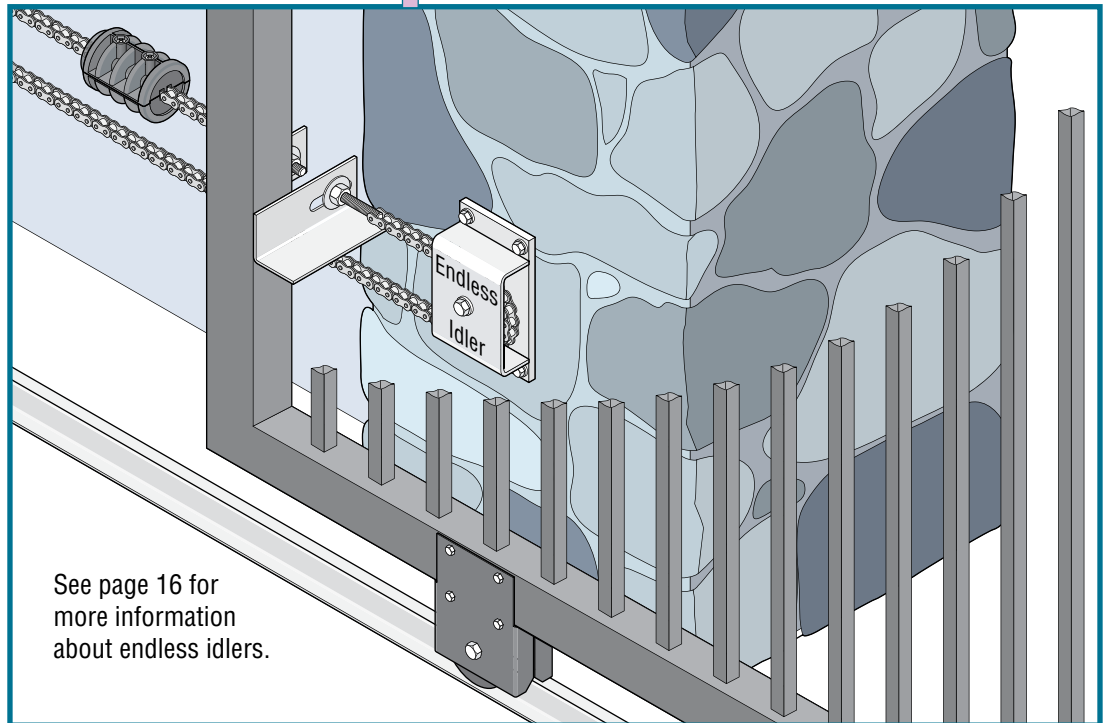

See page 16 for more information about endless idlers.

Rear Position with Post Mount

Hides the chain from outside the property looking in.

- Chain setup is the same as above.

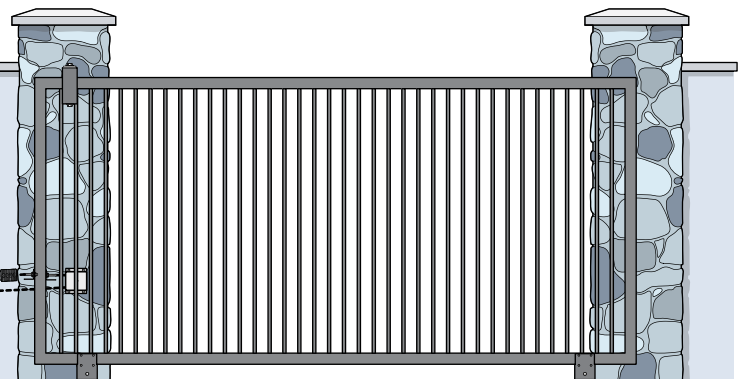
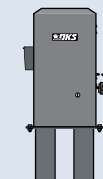

Additional hardware required. Post base plate (P/N 2600-418) 4 x 4 steel posts not available from DoorKing.

Center Position with Post Mount Hides the chain from outside the property looking in.

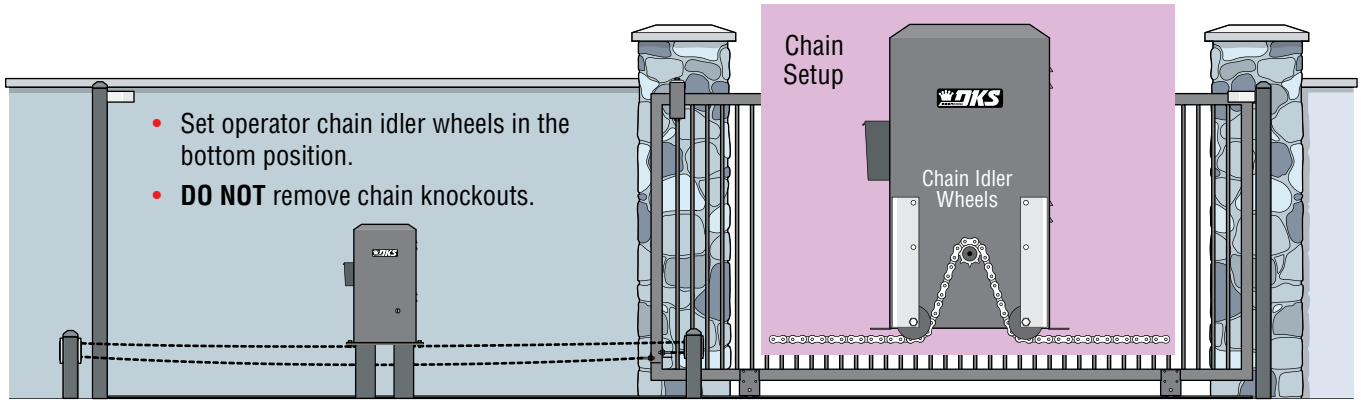

Additional hardware required. Post base plate (P/N 2600-418) 4 x 4 steel posts not available from DoorKing. Endless idler assembly (P/N 2600-818). Additional chain #40 (P/N 2600-442 - 20 ft. per box). Gate end retainer (P/N 1204-004).

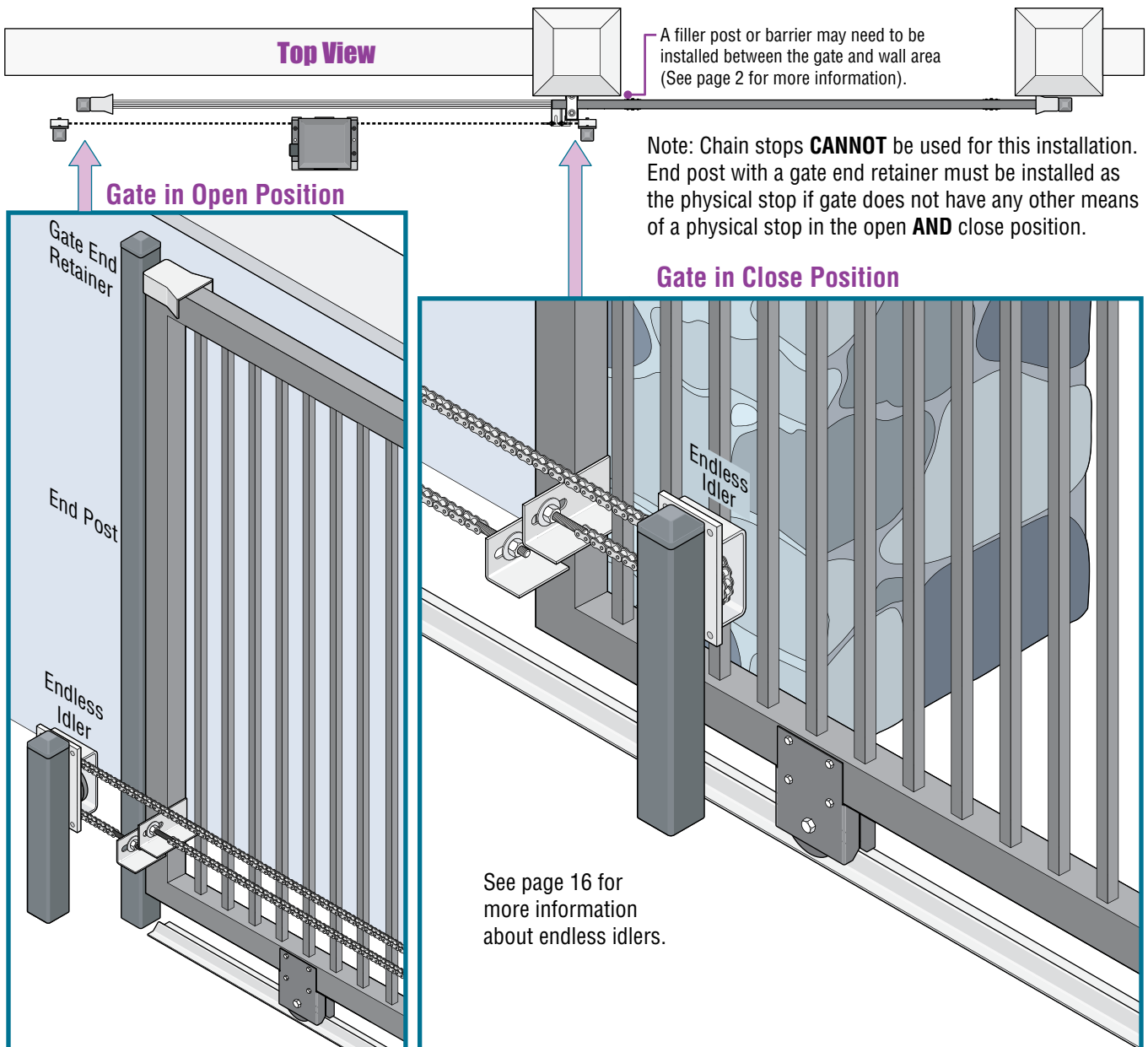

Front or Rear Position Ceiling Mount

Can be mounted on the ceiling to conserve floor space.

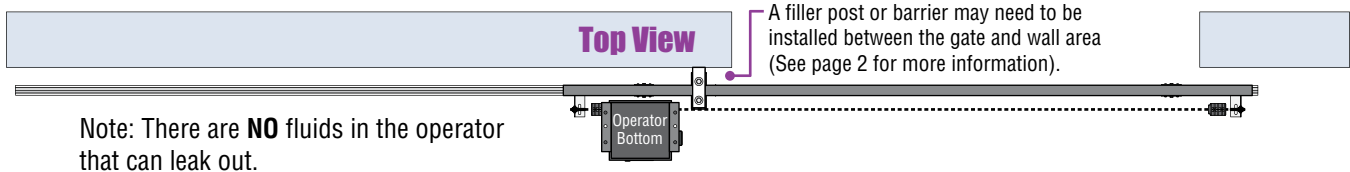
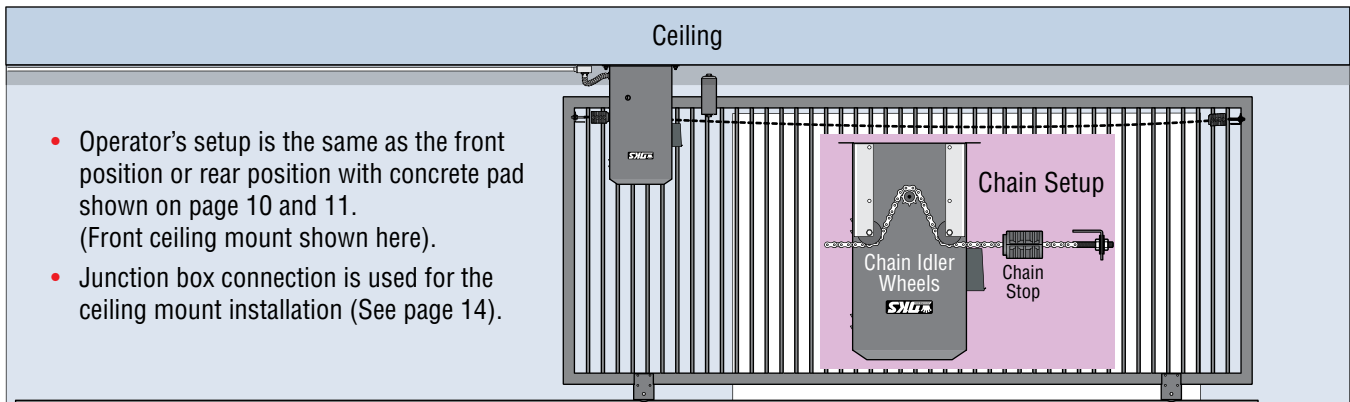

1.5 Underground Conduit Requirements

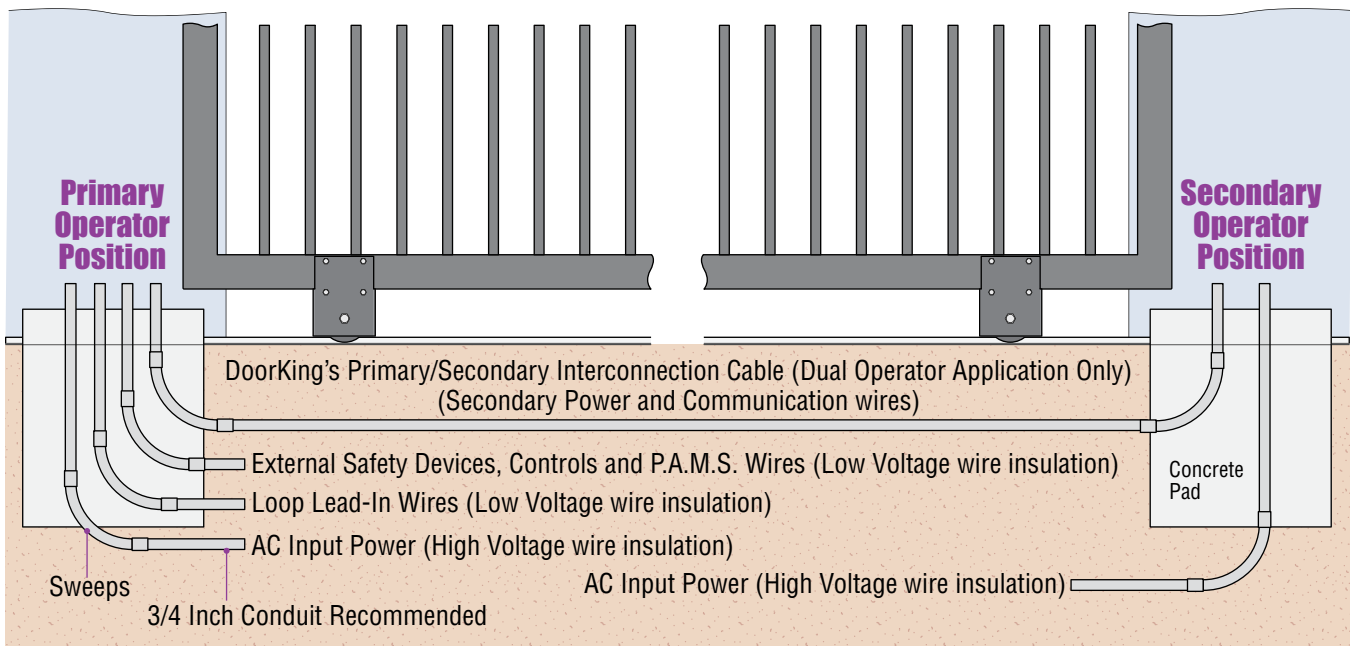

- The conduit requirements are for a typical slide gate operator installation (the secondary operator is shown for those applications where a secondary operator may be used). **The conduit requirements for your application may vary from this depending on your specific needs.**
- Use only sweeps for conduit bends. Do not use 90° elbows as this will make wire pulls very difficult and can cause damage to wire insulation. DoorKing recommends using 3/4-inch conduit.
- Installation of **External Entrapment Protection Devices** are **REQUIRED** (photo sensors and/or reversing edges).
- Be sure that all conduits are installed in accordance with local codes.
- Never** run low voltage rated wire insulation in the same conduit as high voltage rated wire insulation.

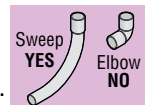

1.6 Pad, Post or Ceiling Mount without/with J-Box Setup

Pad Mount with Conduit

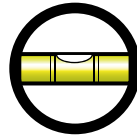
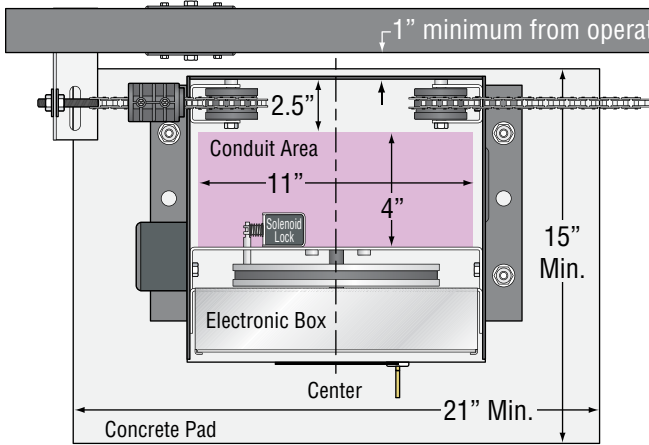

Concrete pad **MUST** be level.

4" min. above ground.

Underground depth of the concrete pad is determined by soil conditions and local building codes. Reinforced concrete recommended.

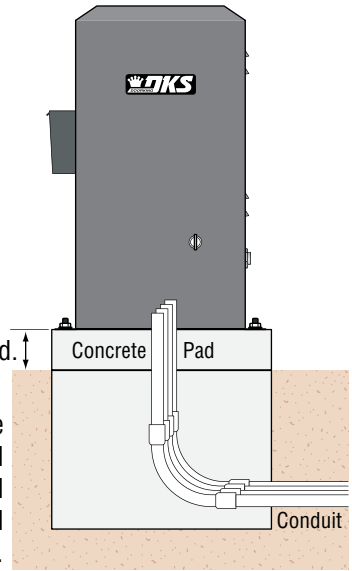

Post Mount with Conduit

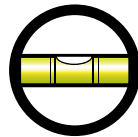
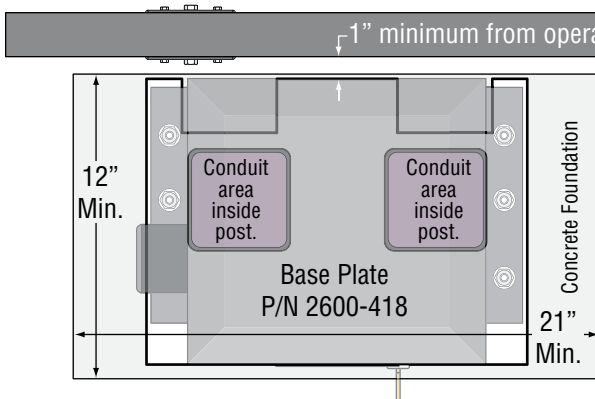

Base Plate **MUST** be level.

4" min. above ground.

Underground depth of the concrete foundation is determined by soil conditions and local building codes. Reinforced concrete recommended.

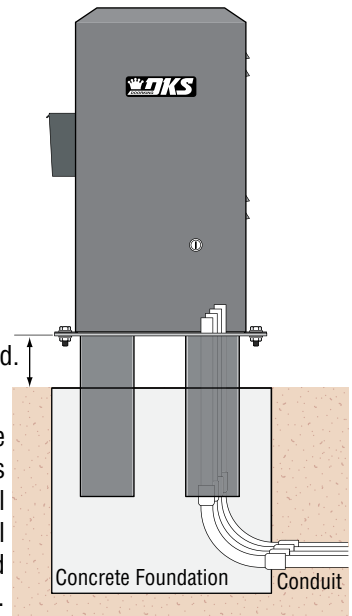

Note: Weld the posts to the base plate and mount assembly into concrete **BEFORE** attaching the operator. Conduit runs up through 4 x 4 steel posts.

Pad, Post or Ceiling Mount Connected with Junction Boxes

All wire connections can be made on **either side** of the operator housing after it has been installed.

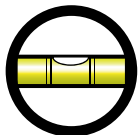

Operator **MUST** be level.

Never run high voltage and low voltage in the same conduit.

Note: Operator must be mounted 1" min. away from gate.

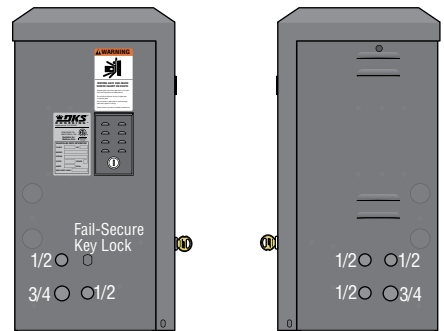
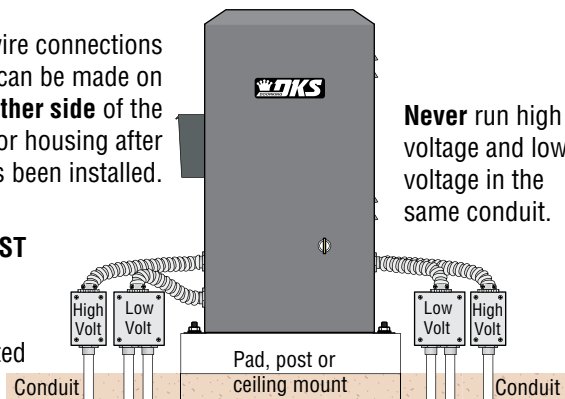

Conduit Knock-Out Sizes

1.7 Mounting Operator and Chain

Prior to mounting the operator, be sure that the correct chain knockouts have been removed and chain idler wheels are in the correct position (top, center or bottom).

Fail-Secure Manual Release Kit Installation Note: It is easier to install the 2600-862 fail-secure manual release kit **before** mounting the operator and attaching the chain. Refer to the instruction sheet supplied with the kit for installation.

Positioning Operator and Chain Brackets

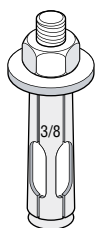
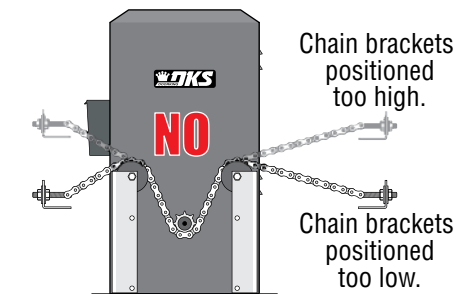
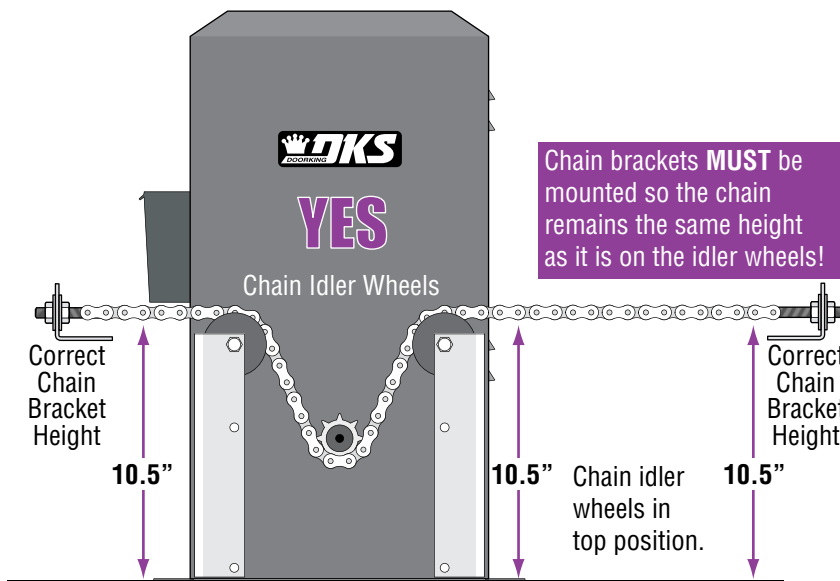
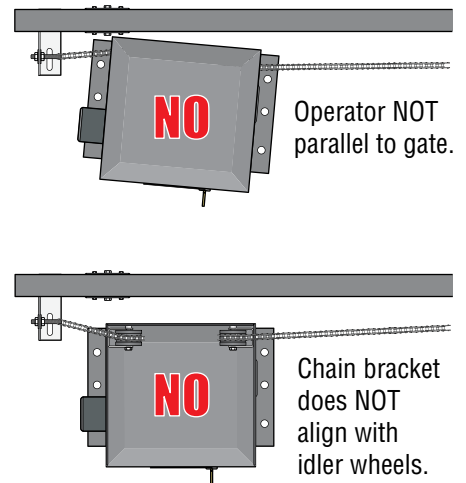
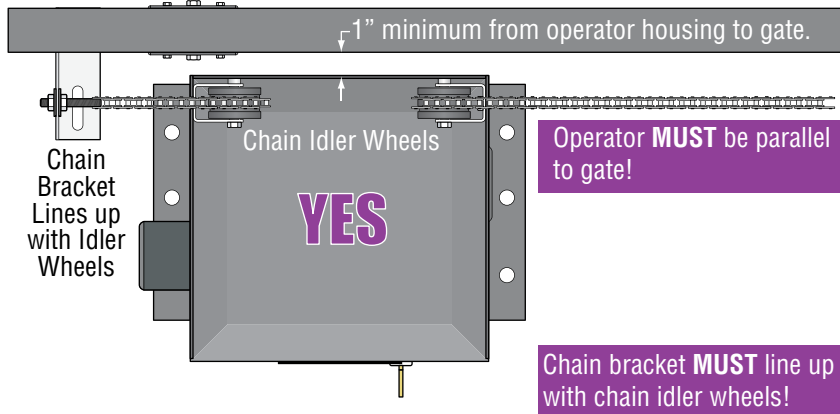

Attaching Operator to Concrete

DoorKing recommends a minimum of four (4) 3/8" x 2" sleeve anchors (not supplied).

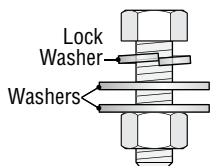

Attaching Operator to Post Base Plate

Use six (6) 1/2"-13 x 1 1/2" bolts, lockwashers and nuts (not supplied).

Connect Chain Bracket to Gate.

Weld completely around bracket. **Chain nut and chain bolt should not protrude past gate frame.**

Connect Chain to Chain Bracket.

Connect chain to chain bolt with master link. Adjust the chain nuts to tighten the chain. The chain should sag no more than one (1) inch per 10 feet of travel. **Do not over tighten the chain.**

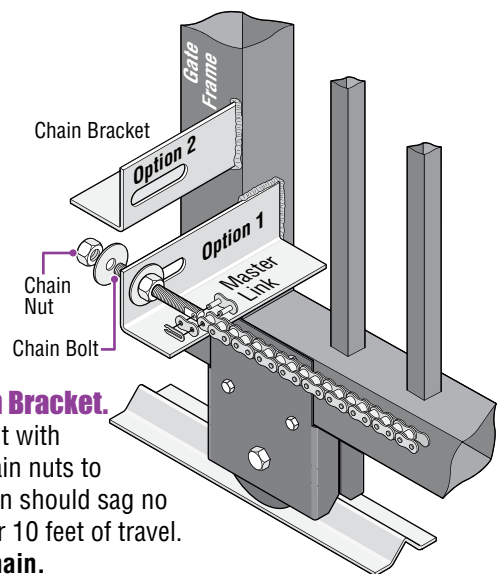

Endless Idler Assembly (On Select Installations)

DoorKing offers an endless idler assembly with a protective cover designed for the Model 9050 installations (P/N 2600-818). Make sure the endless idler assembly is **securely** fastened to the wall or post (Depending on which type of installation will be used). Extreme force will be exerted on this assembly during gate cycling.

Center and Rear Mount Positions (Top View)

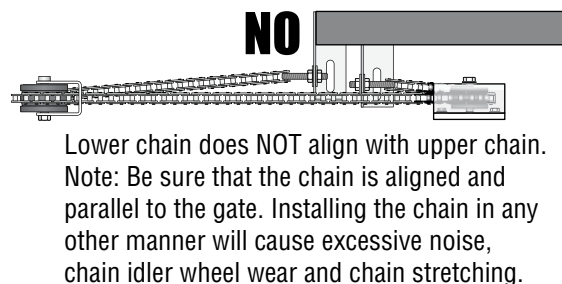
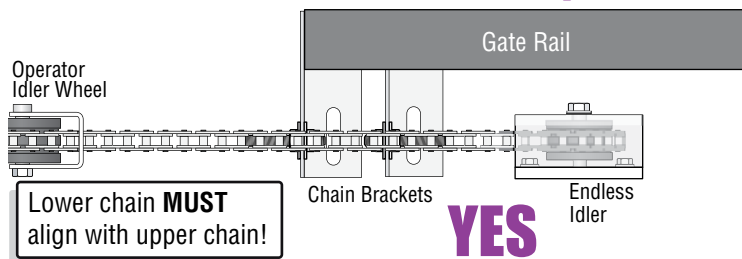

Center Mount Position (Side View)

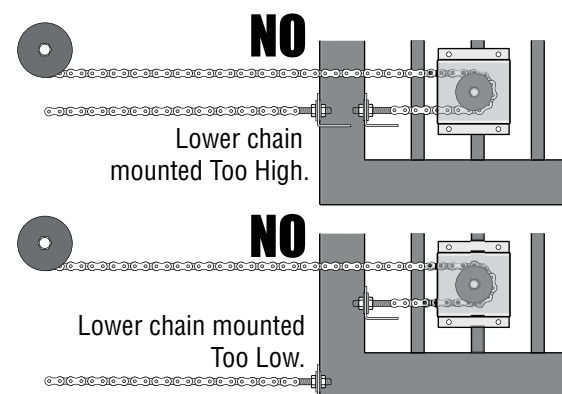
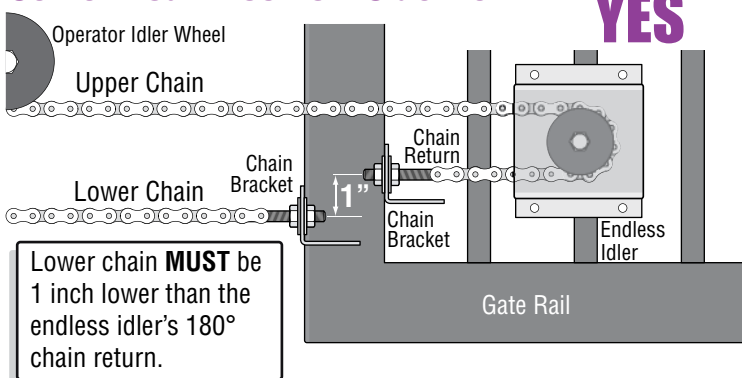

Rear Mount Position (Side View)

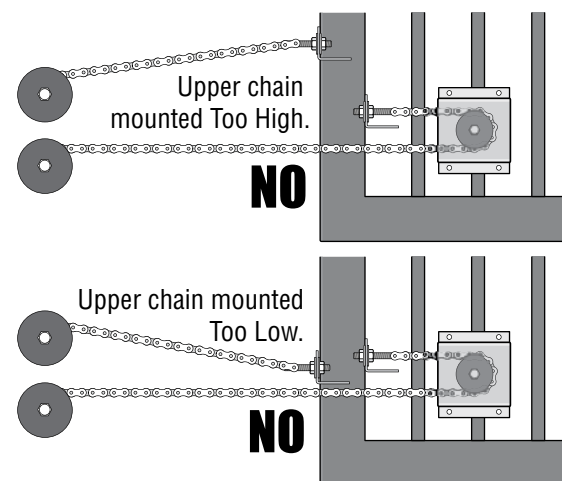
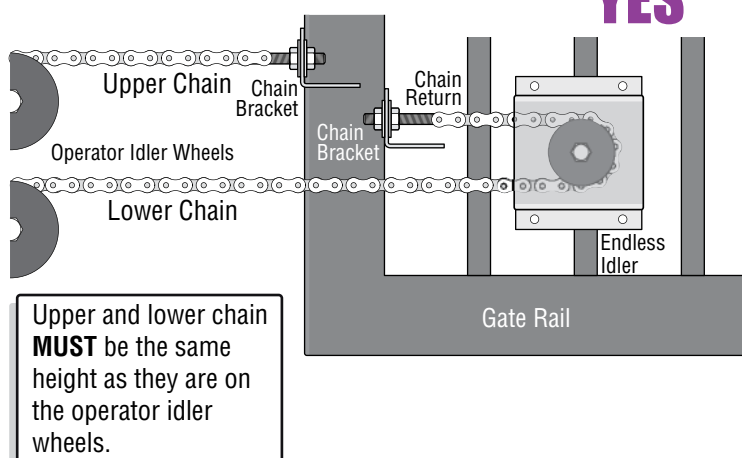

1.8 Installation of Warning Signs

This DoorKing Slide Gate Operator is shipped with two warning signs. The purpose of the warning sign is to alert uninformed persons, and to remind persons familiar with the gate system, that a possible hazard exists so that appropriate action can be taken to avoid the hazard or to reduce exposure to the hazard. See page 3 for suggested mounting positions of signs.

- Warning signs are to be permanently installed in the area of the gate in such a manner that at least one warning sign is visible by persons located on each side of the gate, for both the secure and unsecure sides of the gate.
- Use appropriate hardware such as wood or sheet metal screws (not supplied) to install the warning signs.

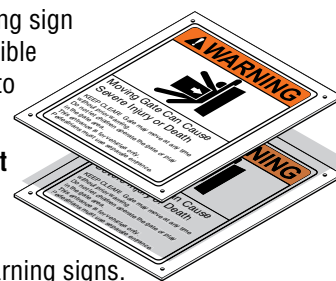

SECTION 2 - AC POWER TO OPERATOR(S)

Before attempting to connect any wiring to the operator, be sure that the circuit breaker in the electrical panel is in the OFF position. Permanent wiring must be installed to the operator as required by local electrical codes. It is recommended that a licensed electrical contractor perform this work.

Since building codes vary from city to city, we highly recommend that you check with your local building department prior to installing any permanent wiring to be sure that all wiring to the operator (both high and low voltage) complies with local code requirements.

THIS GATE OPERATOR MUST BE PROPERLY GROUNDED!!

2.1 High Voltage Wire Runs

If power wiring is greater than the maximum distance shown, it is recommended that a service feeder be installed. When large gauge wire is used, a separate junction box must be installed for the operator connection. The wire table is based on stranded copper wire. Wire run calculations are based on a power source with a 3% voltage drop on the power line, plus an additional 10% reduction in distance to allow for other losses in the system.

Never run low voltage rated wire insulation in the same conduit as high voltage rated wire insulation.

	Wire Size / Max Distance in Feet			
	12 AWG	10 AWG	8 AWG	6 AWG
Single 9050: 5.4 Amp Motor	170	275	460	685
Dual 9050's, Single Power Source	85	135	230	340

“Optional” 3.3 Amp Heater Installation Note: When installing the heater(s), refer to the “high voltage AC power wire size and distance requirements” table on the instruction sheet with the heater kit (P/N 1601-154) for AC power wire run requirements.

2.2 High Voltage Terminal Connection

- Route incoming AC power wire through the high voltage conduit and run wire in the operator as shown.
- Be sure wiring is installed in accordance with local codes. Be sure to color code all wiring.
- It is recommended that a surge suppressor be installed on the high voltage power lines to help protect the operator and circuit board from surges and power fluctuations.
- Dual operators (Primary/Secondary) require AC power to **EACH** operator.

DO NOT power up and cycle the operator until the “Physical stops” have been installed. **Damage could occur to the gate and operator.**

IMPORTANT:

Electronic box **MUST** be in the down position and secured for operator to function.

EXTERNAL ENTRAPMENT PROTECTION DEVICES MUST be connected or the gate operator WILL NOT function. (See pages 22-25)

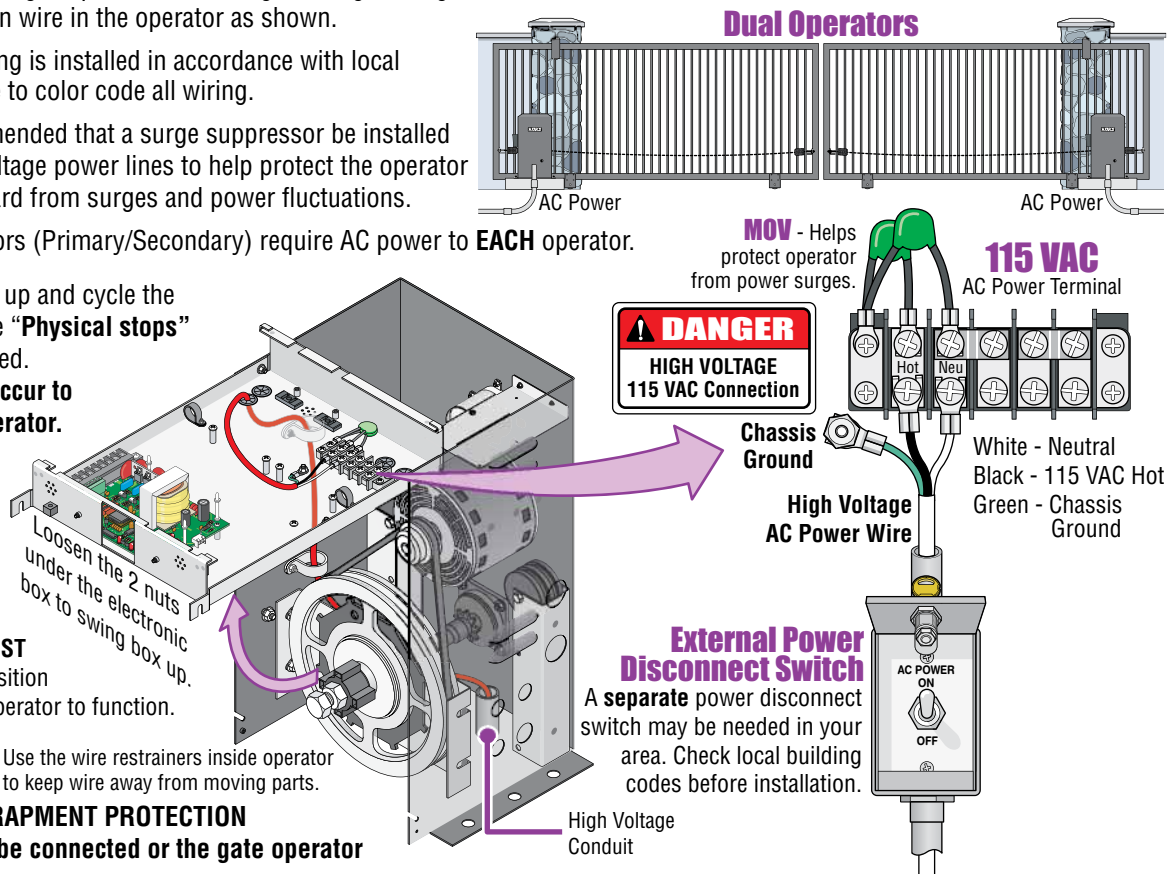

⚠ Every time the operator is powered up, the First open command will automatically run “Multiple gate cycles” that will locate and remember the gate’s open and close positions (See page 20).

SECTION 3 - ADJUSTMENTS

The switch settings and adjustments in this chapter should be made after your installation and wiring to the operator(s) is complete. **Whenever any of the programming switches on the circuit board are changed, power must be shut-off, and then turned back on for the new setting to take effect. Every time** the operator is powered up, the **First** open command will automatically run **“Multiple gate cycles”** that will locate and remember the gate’s open and close positions (See page 20).

3.1 4702 Circuit Board Description and Adjustments

LEDs Indicates that low voltage power is applied to the circuit board. **Input LEDs** should be OFF and will only illuminate when the input is activated. **Pulse LEDs** will blink as the operator is running. They can be either ON or OFF when the operator is stopped.

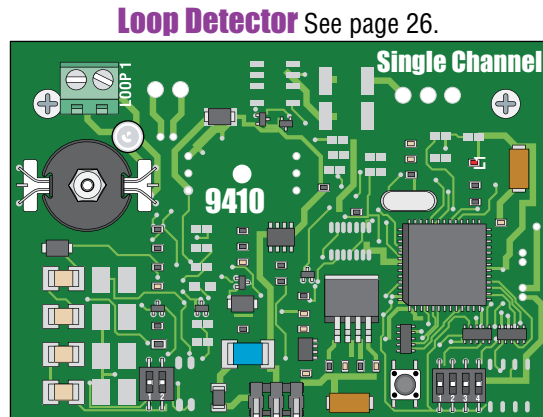

Loop Detector See page 26.

Auto-Close Timer

Auto-close timer (when turned **ON**) Switch 2.

Adjust from 1 second (full counter clockwise) to approximately 23 seconds (full clockwise).



Loop Detector See page 26.

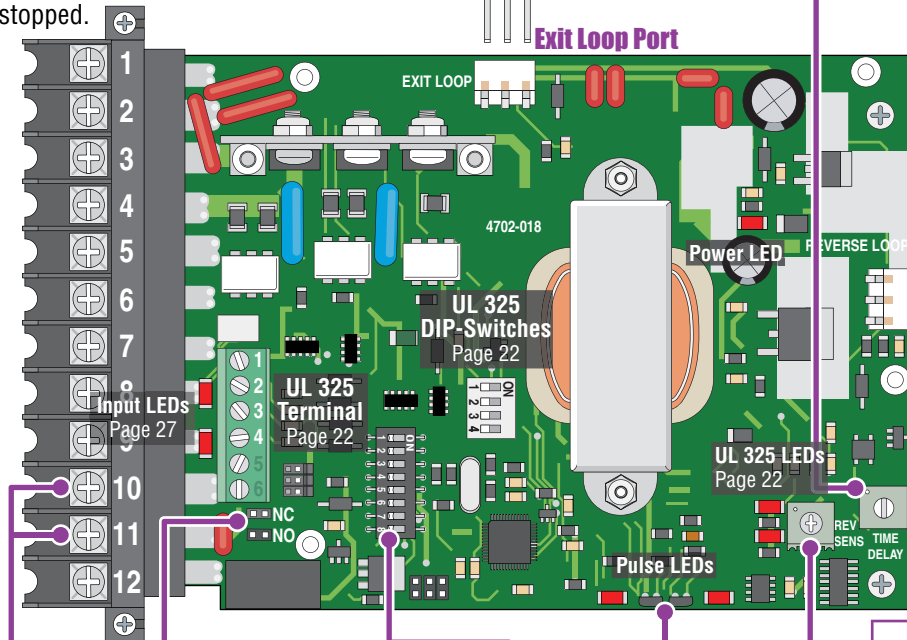
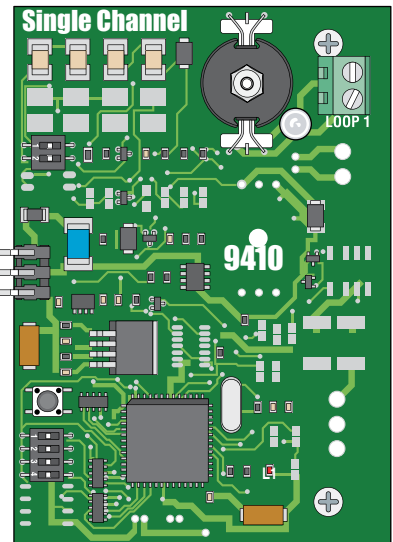

Dry Relay Contact

Dry relay contacts (terminals 10-11) can be set for Normally Open (NO) or Normally Closed (NC) operation by placing the relay shorting bar on the N.O. or N.C. pins respectively. Relay activates **ONLY** when gate is in the **FULL open** position.

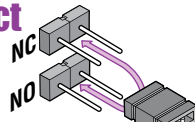

Magnetic Sensors

See section 3.4 on page 21. **Pulse LEDs** will blink as the operator is running. They can be either ON or OFF when the operator is stopped.

DIP-Switches

Typical setting shown. See switch setting chart on next page for DIP-Switch options.



Inherent Reverse Sensor

Adjust reversing sensitivity. Full counter clockwise for minimum sensitivity, full clockwise for maximum sensitivity. See page 21.

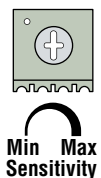

3.2 DIP-Switch Settings

The DIP-switches located on the circuit board are used to program the operator to operate in various modes and to turn on or off various operating features. Whenever a switch setting is changed, power to the operator must be turned OFF and then turned back on for the new setting to take affect. Check and review ALL switch settings prior to applying power to the operator.

⚠ Every time the operator is powered up, the First open command will automatically run “Multiple gate cycles” that will locate and remember the gate’s open and close positions (See next page).

Switch	Function	Setting	Description
1	Changes the direction the operator will open/close the gate depending on the different chain configurations.		
2	Auto-Close Timer	OFF	Auto-close timer is OFF. Manual input required to close gate.
		ON	Auto-close timer is ON. Adjustable from 1-23 seconds to close gate.
3	Spare	OFF	Leave on OFF setting.
4	Built-In Solenoid Lock See Page 32-33	OFF	Normal Setting. Fail-Safe (Factory Set). Lock engages only when an attempt is made to manually force the gate open.
		ON	Fail-Secure. Lock engages after each cycle. CAUTION: Do not use this setting unless the 2600-862 manual release kit has been installed or damage will occur to operator.
5 and 6	Gate Open Back-Off Position	5-OFF 6-OFF	Normal Setting. Gate fully opens.
		5-OFF 6-ON	Gate stops short 1” from full open position. Used for a reversing edge device.
		5-ON 6-OFF	Gate stops short 2” from full open position. Used for a reversing edge device.
		5-ON 6-ON	Gate stops short 3” from full open position. Used for a reversing edge device.
7 and 8	Gate Close Back-Off Position	7-OFF 8-OFF	Normal Setting. Gate fully closes.
		7-OFF 8-ON	Gate stops short 1” from full close position. Used for a reversing edge device.
		7-ON 8-OFF	Gate stops short 2” from full close position. Used for a reversing edge device.
		7-ON 8-ON	Gate stops short 3” from full close position. Used for a reversing edge device.

Switch 1 Must OPEN the gate upon initial AC power up and open command. If the first open command begins to close the gate, turn AC power off and reverse this switch. Opening direction will vary depending on the chain setup position (See above).

Switch 2 Turns the auto-close timer on or off. Can be adjusted from 1 to 23 seconds to close gate.

Switch 3 Leave switch in **OFF** position.

Switch 4 This switch determines the operation of the built-in solenoid lock. The OFF setting is the factory setup. **Caution: Do not set this switch to ON unless the 2600-862 fail-secure manual release kit has been installed in the operator.** Changing this switch to the ON setting without installing the lock kit will damage the operator. See pages 32 and 33 for more information about Fail-Safe vs. Fail-Secure release systems.

Switches 5-6 These work in conjunction with each other and determine if the operator will stop the gate at the full open position, or if the gate should stop 1, 2 or 3 inches short of the full open position. Needed only when using a reversing edge entrapment protection device on the **opening** edge of the gate with an end post as the physical stop.

Switches 7-8 These work in conjunction with each other and determine if the operator will stop the gate at the full close position, or if the gate should stop 1, 2 or 3 inches short of the full close position. Needed only when using a reversing edge entrapment protection device on the **closing** edge of the gate with an end post as the physical stop.

3.3 Automatic Open / Close Limit Adjustment

The operator's open/close limits **DO NOT** have to be physically adjusted. **Every time the operator is powered up, the first open command will automatically run “Multiple gate cycles” that will locate and remember the gate's open and close positions.** These positions are determined by the physical stops that have been installed (See section 1.2, page 8).

Timer: The Auto-Close Timer should be turned ON (DIP-Switch 2) to allow the “multiple gate cycles” to run automatically, otherwise manual close commands will be required to complete this sequence.

Clutch: The clutch's factory setting will work correctly for most installations. The clutch must **NOT** slip while the gate is cycling **between** the full open and full closed position or the gate limits will be incorrect. If the clutch slips during this period, it must be tightened before running this sequence (See section 3.4 on the next page).

Safety Devices: Run this sequence **before** testing any safety features (primary inherent reverse sensor, external entrapment protection, entrapment alarm and reset features).

Reversing Edge mounted on the Gate using End Posts: When using a reversing edge on either end of the gate with an **end post as the physical stop**, the reversing edge must be disconnected from the circuit board every time this sequence will be run (the UL 325 terminal can be unplugged from the circuit board).

Sequence of Automatic “Multiple Gate Cycles” to Set Gate Limits

⚠ CAUTION: Keep pedestrians and vehicles clear of the gate while this sequence is running!

After the first open command is given to the operator (gate can be in any position):

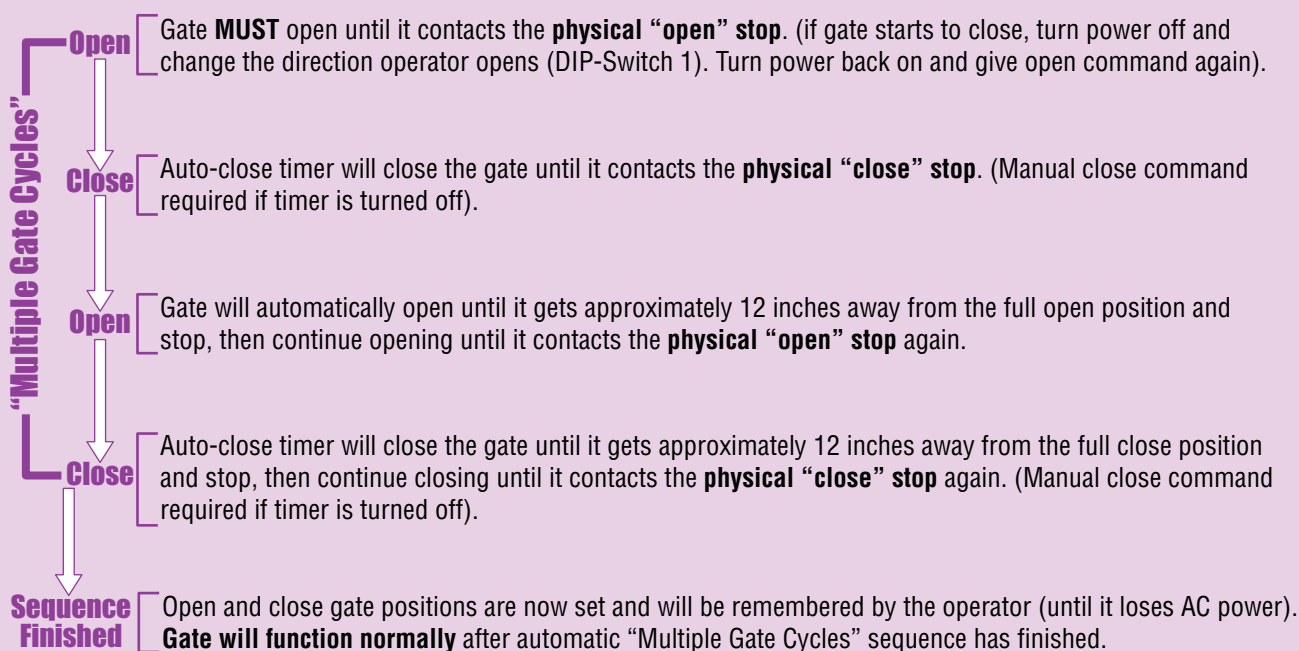

Note: If gate encounters an obstruction during this sequencing, it will automatically continue after obstruction has been cleared.

3.4 Clutch Adjustment

In addition to the inherent reverse sensor, this operator is equipped with a mechanical slip clutch to further reduce the possibility of injury should an entrapment occur. **DO NOT** over tighten the clutch to compensate for a gate that is damaged, poorly constructed or too heavy. **Over tightening the clutch would create a hazard** which could result in severe injury or death to persons who may become entrapped.

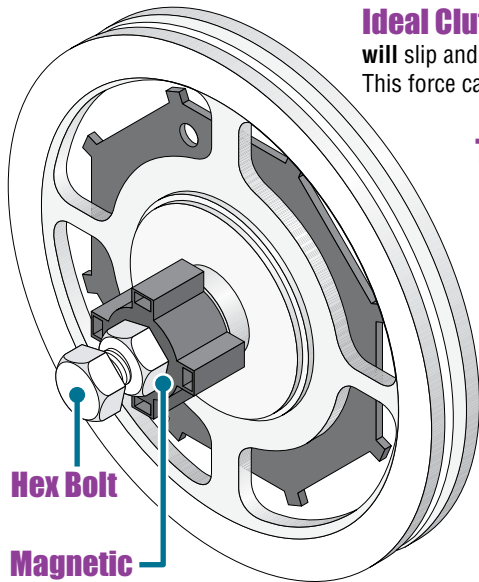

Hex Bolt

Magnetic Spring Assembly

Hex nut is connected to black plastic magnet holder.

Important Note: 2 magnetic sensors located on the bottom of the circuit board sense when the magnetic spring assembly is slipping during operation. Keep all high voltage wires away from the 2 sensors to avoid any electrical interference between the sensors and magnets.

Ideal Clutch Adjustment: The operator will cycle the gate **without** the clutch slipping. The clutch **will** slip and the gate will reverse **ONLY** after striking an obstruction with no more than 75 Lbs of force. This force can be measured with a gate scale.

To adjust clutch:

- 1 Make sure power to operator is OFF when adjusting clutch.
- 2 Hold large pulley to loosen the hex bolt counter clockwise.
- 3 Magnetic spring assembly can now be loosened (counter clockwise) or tightened (clockwise) to adjust the clutch.
- 4 Tighten the hex bolt to lock assembly after adjustment.

Note: After power has been turned back on, the first open command will automatically run the “multiple gate cycles” to locate and remember the open and close gate positions (See section 3.4 on previous page).

Test the operator clutch adjustment:

CAUTION: Keep pedestrians and vehicles clear of the gate while testing clutch!

Place an immobile object along the gate path, allowing the gate to strike it while in the **open** and **close** cycles. The clutch **must** slip and the gate **must** reverse direction after striking the object. If it does not, readjust the clutch. Repeat this test until the correct clutch adjustment has been achieved. The operator will assume a soft shutdown after striking and reversing the gate which will require a key switch command to cycle operator again.

3.5 Inherent Reverse Sensor Adjustment

This vehicular gate operator is equipped with an inherent adjustable reversing sensor (Type A) used as entrapment protection according to UL 325 standards. **The gate will reverse direction after “physically” encountering an obstruction in either the opening or closing gate cycle.**

If the Auto-Close Timer (DIP-switch 2) is ON and the gate physically encounters an obstruction during the **CLOSING** cycle, it will reverse to the open position and **HOLD** the gate at this position (Soft shutdown condition). Another input command is needed before the gate will reset and close again.

For the reverse system to function correctly, the gate must be properly installed and work freely in both directions. **The clutch must be properly adjusted before adjusting the reverse sensor.**

- 1 Give open command to cycle the gate or momentarily jumper terminals 8 and 12 to open gate.
- 2 While gate is cycling, slowly rotate reverse sensor clockwise until the gate reverses direction. Rotate reverse sensor back counter-clockwise approximately 1/8 turn.
- 3 Cycle the gate a few times to be sure that it cycles completely.

Note: Each operator must be individually adjusted if dual operators have been installed.

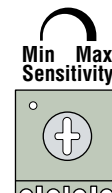

Reverse Sensitivity

Test the operator reversing sensitivity:

Place an immobile object along the gate path, allowing the gate to strike it while in the **open** and **close** cycles. The gate must reverse direction after striking the object. If it does not, increase the reverse sensitivity (step **2**) and repeat this test until the correct sensitivity has been set. The operator will assume a soft shutdown after striking and reversing the gate which will require a key switch command to cycle operator again.

SECTION 4 - ENTRAPMENT AND SAFETY PROTECTION

External Entrapment Protection Devices:

In addition to the inherent reversing sensor system, this operator has a UL 325 terminal for the connection of **photo sensors**-Type B1 and/or **reversing edges**-Type B2 entrapment protection required by UL 325 standards. Install these devices where the risk of entrapment or a safety hazard exists, examples of which are shown below and the next 3 pages. Installations can vary.

Entrapment Protection must be provided for the gate system where the risk of entrapment or obstruction exists. The operator will NOT run without ONE or more monitored type B1 or B2 external entrapment protection devices installed in EACH direction of gate travel (minimum of 2 external devices required).

4.1 UL 325 Description

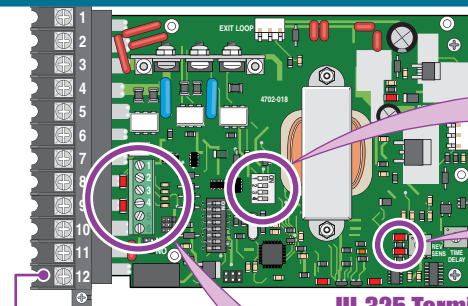

#12 low voltage common
Ground (Common) Note:
Connect all Ground (Common) inputs to main terminal #12 low voltage common.

- UL 325 Terminal**
Connect **ONLY MONITORED** Devices
All inputs are normally closed (NC).
- 1 OPEN Beam - DIP-Switch 1
 - 2 CLOSE Beam - DIP-Switch 2
 - 3 OPEN Edge - DIP-Switch 3
 - 4 CLOSE Edge - DIP-Switch 4
 - 5 Alarm Reset (Factory wired)
 - 6 Entrapment Alarm (Factory wired)

UL 325 DIP-Switches

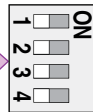

- 1 - OPEN Beam
 - 2 - CLOSE Beam
 - 3 - OPEN Edge
 - 4 - CLOSE Edge
- DIP-switches **MUST** be turned **ON** for each device wired to terminal.

UL 325 LEDs

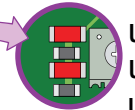

- UL 325 Terminal 1 or 2
- UL 325 Terminal 3 or 4

UL 325 LEDs Note:
LED ON: Connected device has been activated.
LED remains OFF during normal operation.
LED Flashing: Connected device is in fault.
Wiring to device is bad.

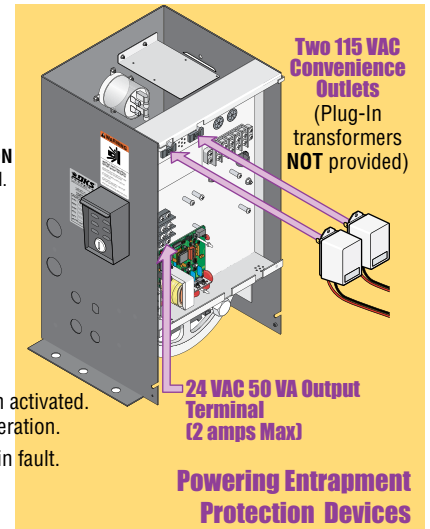

Monitored Device Note: Only 1 monitored Device can be connected to each input. An **OPTIONAL** Expansion Board (sold separately) will allow connection for additional devices.

Device Terminal Number/Function and General Location

1 OPEN Beam: Obstructed opening-direction photo beam will stop the gate **during the opening-direction only**. Gate will resume the open cycle when the obstructed photo beam has been cleared.

2 CLOSE Beam: Obstructed closing-direction photo beam will reverse the gate to the open position and reset the close-timer **during the closing-direction only**. Gate will close when timer times out.

3 OPEN Edge: Obstructed reversing edge will reverse the gate to the close position **during the opening-direction only**.

- After the gate reverses to the close position, any opening input will cycle the gate again.

Note: If the gate is opening by a time clock and the edge gets obstructed, the gate will return to the closed position and another input (automatic exit loop, reverse loop, remote etc.) is needed to cycle the gate open again.

4 CLOSE Edge: Obstructed reversing edge will reverse the gate to the open position **during the closing-direction only**.

- After the gate reverses to the open position, the close-timer will time out and close the gate (if it is turned on).
- If a second sequential obstruction is encountered prior to the gate reaching the close limit, the gate will **reverse to full open position** and enter a soft shutdown condition (See page 31).

5 Alarm Reset: This input turns off the entrapment alarm and resets the operator after a hard shutdown occurs. Factory wired.

6 Entrapment Alarm: This is an output from the circuit board that drives the entrapment alarm. **Do not connect any other device to this terminal.** Factory wired.

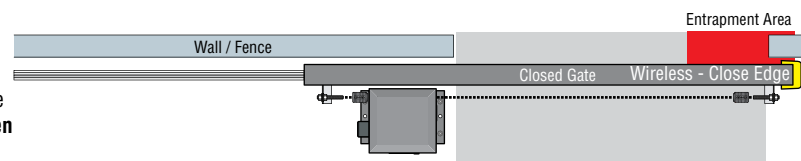
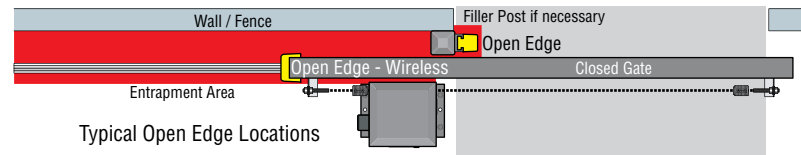
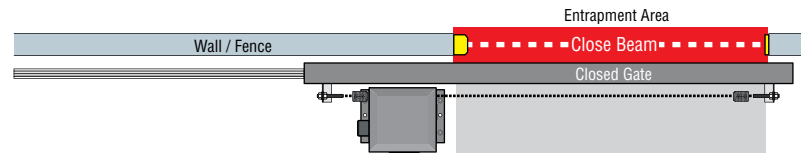
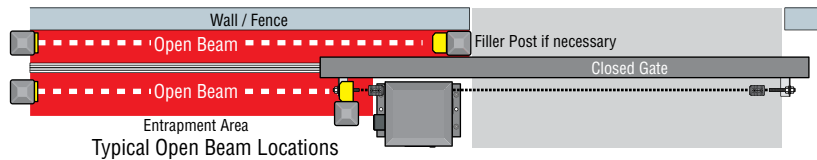

4.2 Entrapment Protection Device Locations

Typical UL Photo Sensor mounting height and distance away from gate.

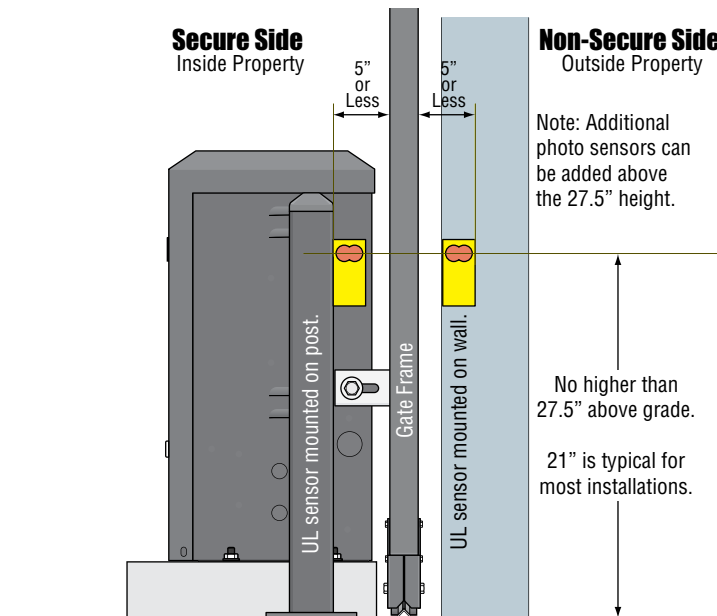
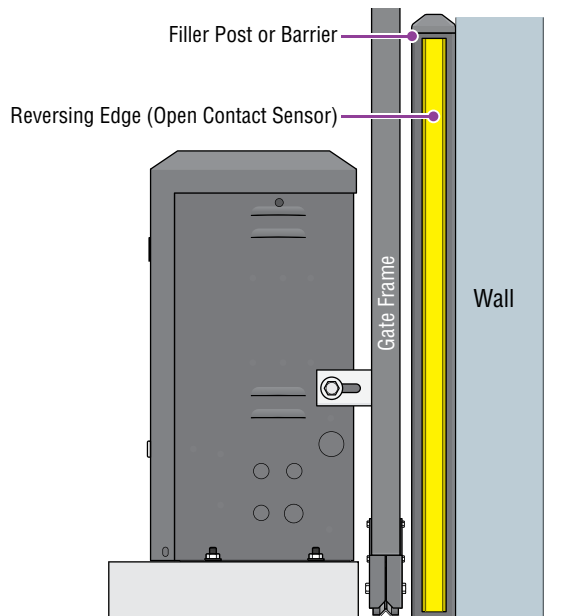

Photo sensors may be installed on either side of gate frame, as close as practical to the gate but no further away than 5".

If the distance between the gate and wall is greater than 2 1/4".



A filler post or barrier may need to be installed between the gate and wall area to reduce the distance to 2 1/4" or less. A reversing edge should be installed on the post or barrier for safety (See page 2 for more information).

Photo Sensors (With Filler Post and Reverse Edge) Sample Setup

Entrapment Protection must be provided for the gate system where the risk of entrapment or obstruction exists. The operator will NOT run without ONE or more monitored type B1 or B2 external entrapment protection devices in EACH direction of gate travel (minimum of 2 external devices required).

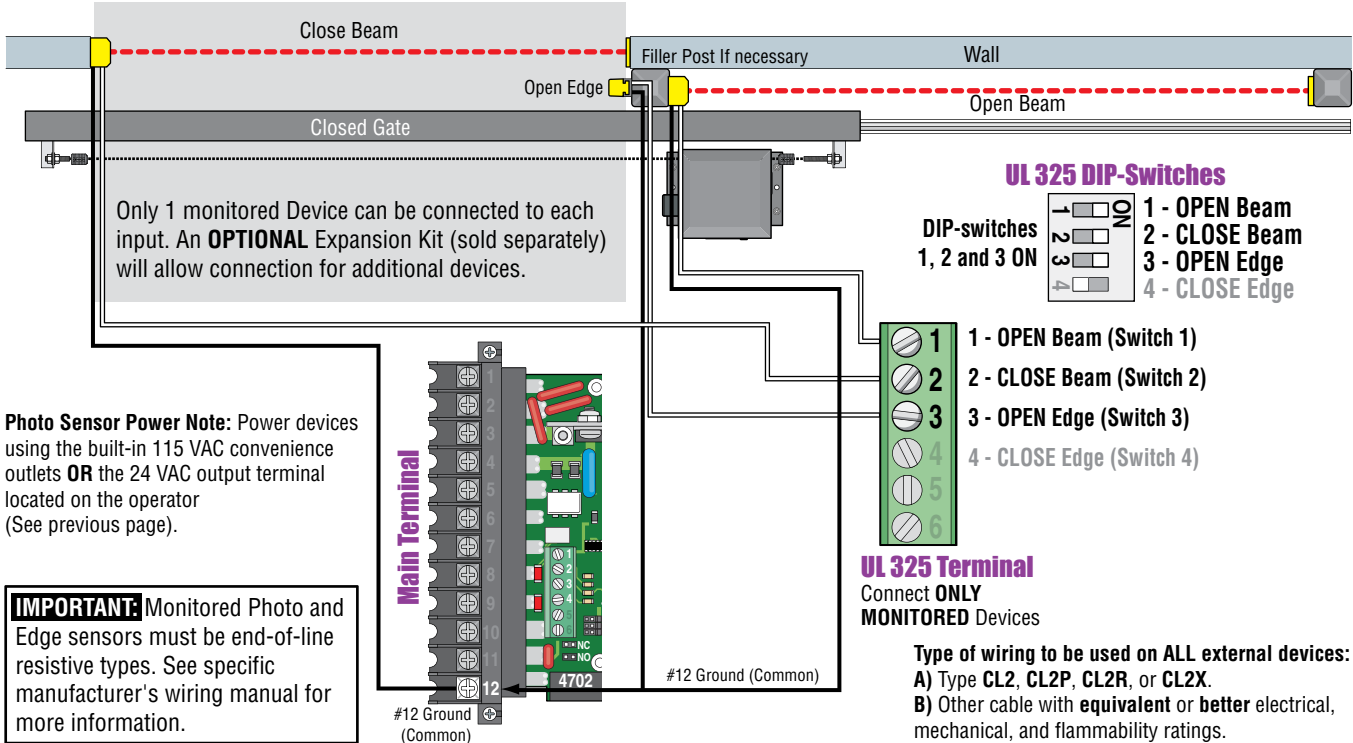

Wireless Reverse Edge Sample Setup - Single Receiver

Type of wiring to be used on ALL external devices:

A) Type CL2, CL2P, CL2R, or CL2X.

B) Other cable with equivalent or better electrical, mechanical, and flammability ratings.

P/N - 8080-008 RF Monitored Gate Link Kit (RB-G-K10)

Miller Edge Sensing Edges - All models with a T2 (resistive) termination.

Entrapment Protection must be provided for the gate system where the risk of entrapment or obstruction exists. The operator will NOT run without ONE or more monitored type B1 or B2 external entrapment protection devices in EACH direction of gate travel (minimum of 2 external devices required).

IMPORTANT: Monitored Photo and Edge sensors must be end-of-line resistive types. See specific manufacturer's wiring manual for more information.

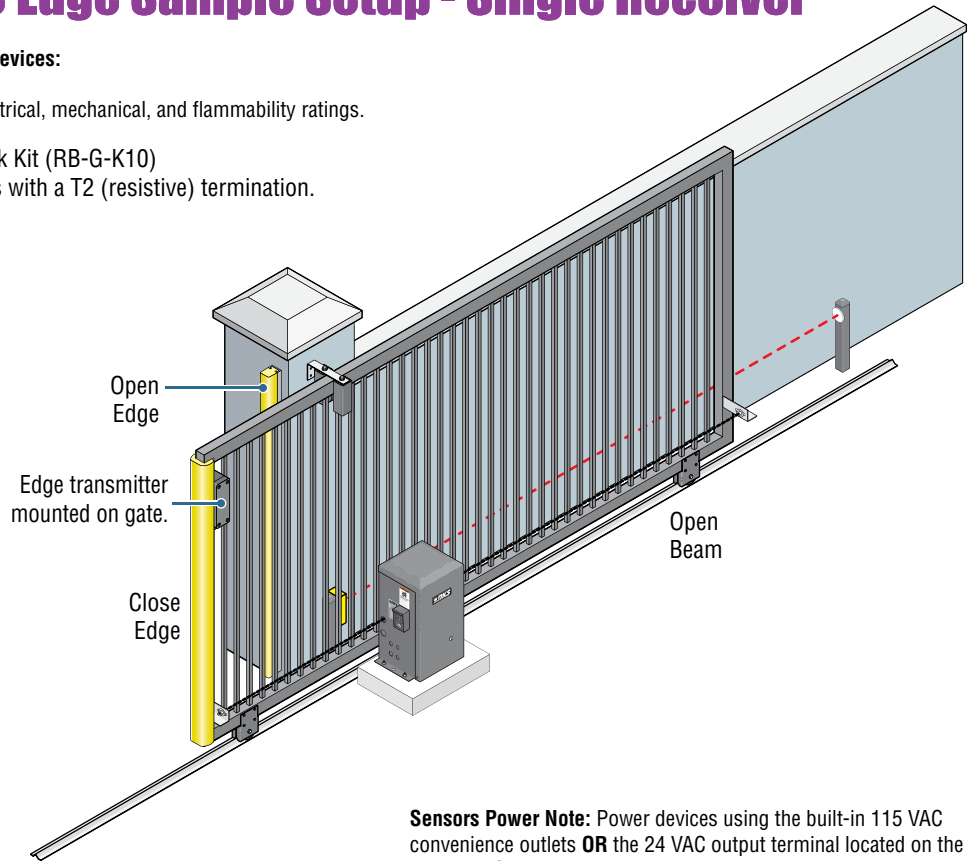

Sensors Power Note: Power devices using the built-in 115 VAC convenience outlets OR the 24 VAC output terminal located on the operator (See page 22).

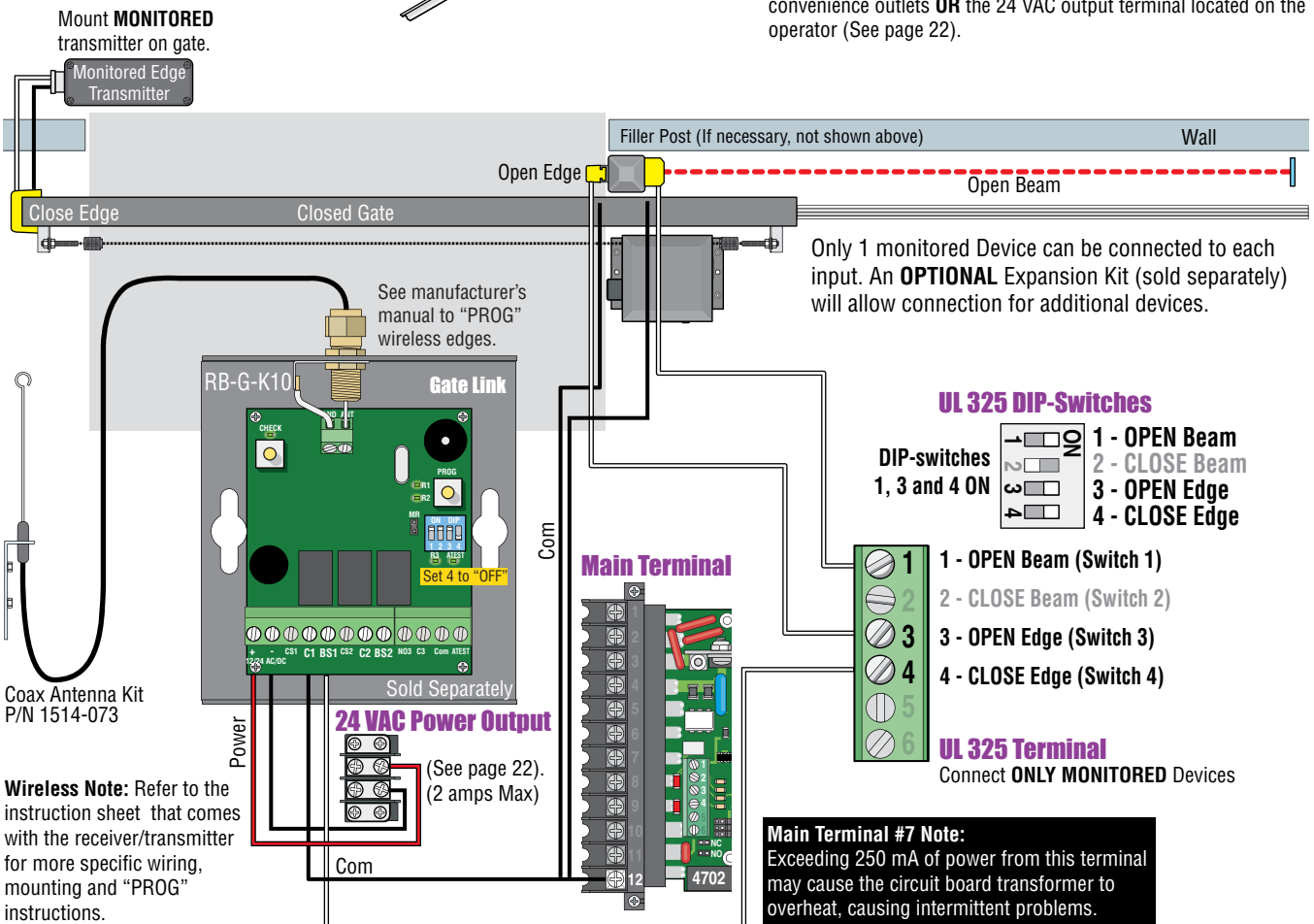

4.3 Dual Gates Multiple Reversing Edges Wiring Sample

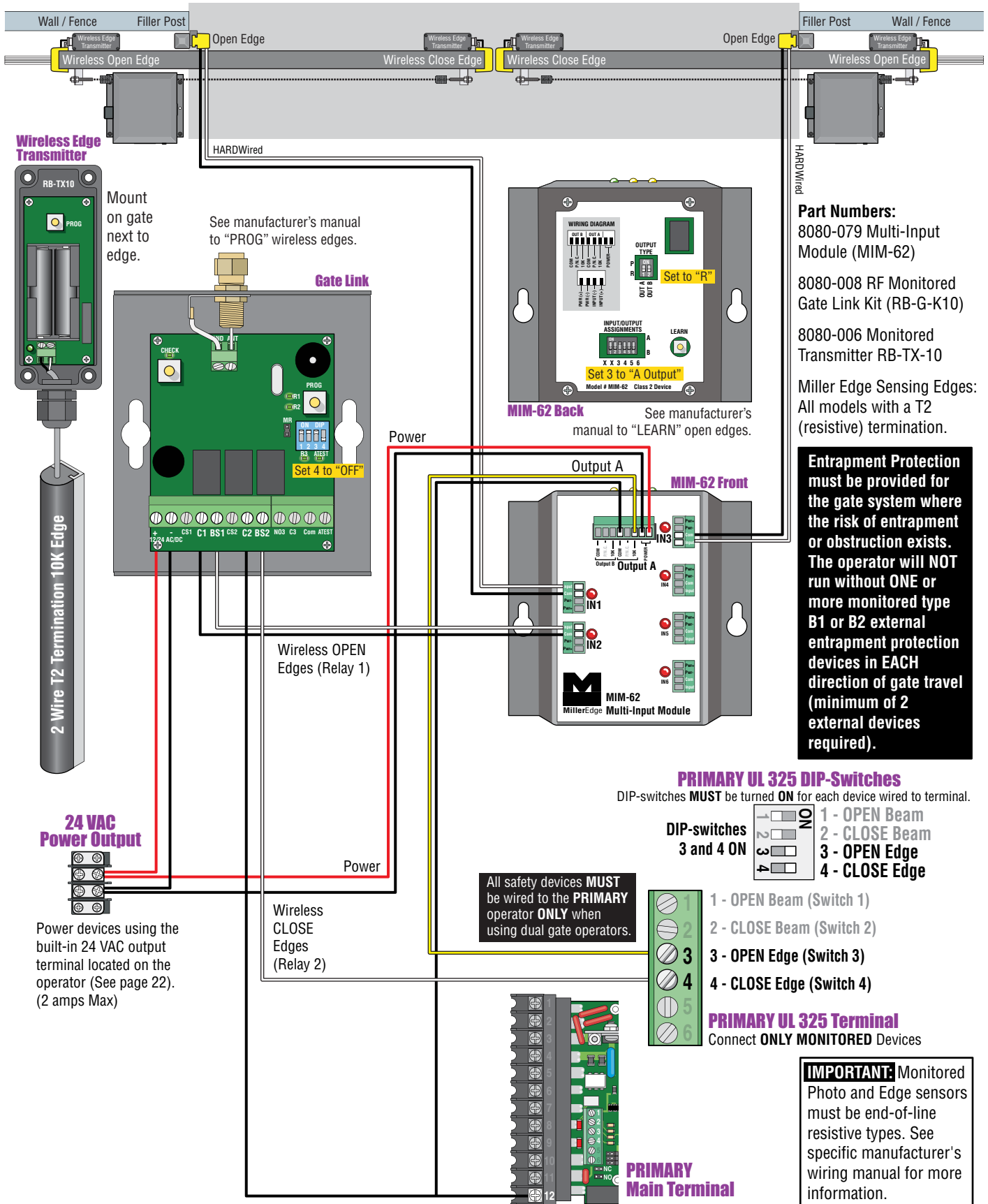

4.4 Loop Detector Wiring

To help protect the operator from accidentally closing on vehicles in the gate's path, DoorKing highly recommends that loops and loop detectors be installed. Loops are laid underneath, cut into asphalt or concrete driveways or buried beneath gravel and earth driveways. A loop detection system will sense a vehicle like a metal detector and send a signal to the gate operator preventing the gate from automatically opening or closing on a vehicle when it is in the gate's path. DoorKing recommends that a licensed installer perform this work.

DoorKing offers a free **"Loop and Loop-Detectors Information Manual"** PDF located at DoorKing's web site for more information. www.doorking.com

Reverse Loops

Reverse loops are placed on each side of the gate to prevent the gate from closing on a vehicle in the gate's path. They will reverse the cycling of the gate while a vehicle is in or near the gate's pathway.

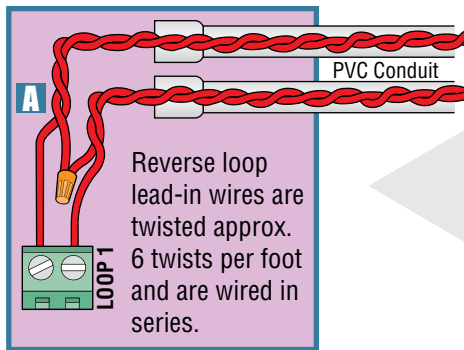

Automatic Exit Loop

Automatically opens the gate for exiting vehicles without having to use a transmitter or keypad. The exit loop can be placed a minimum of 4 feet away from the reverse loop or far enough away from the gate so the gate has started opening or even completely opened by the time you drive up to it (Free exit).

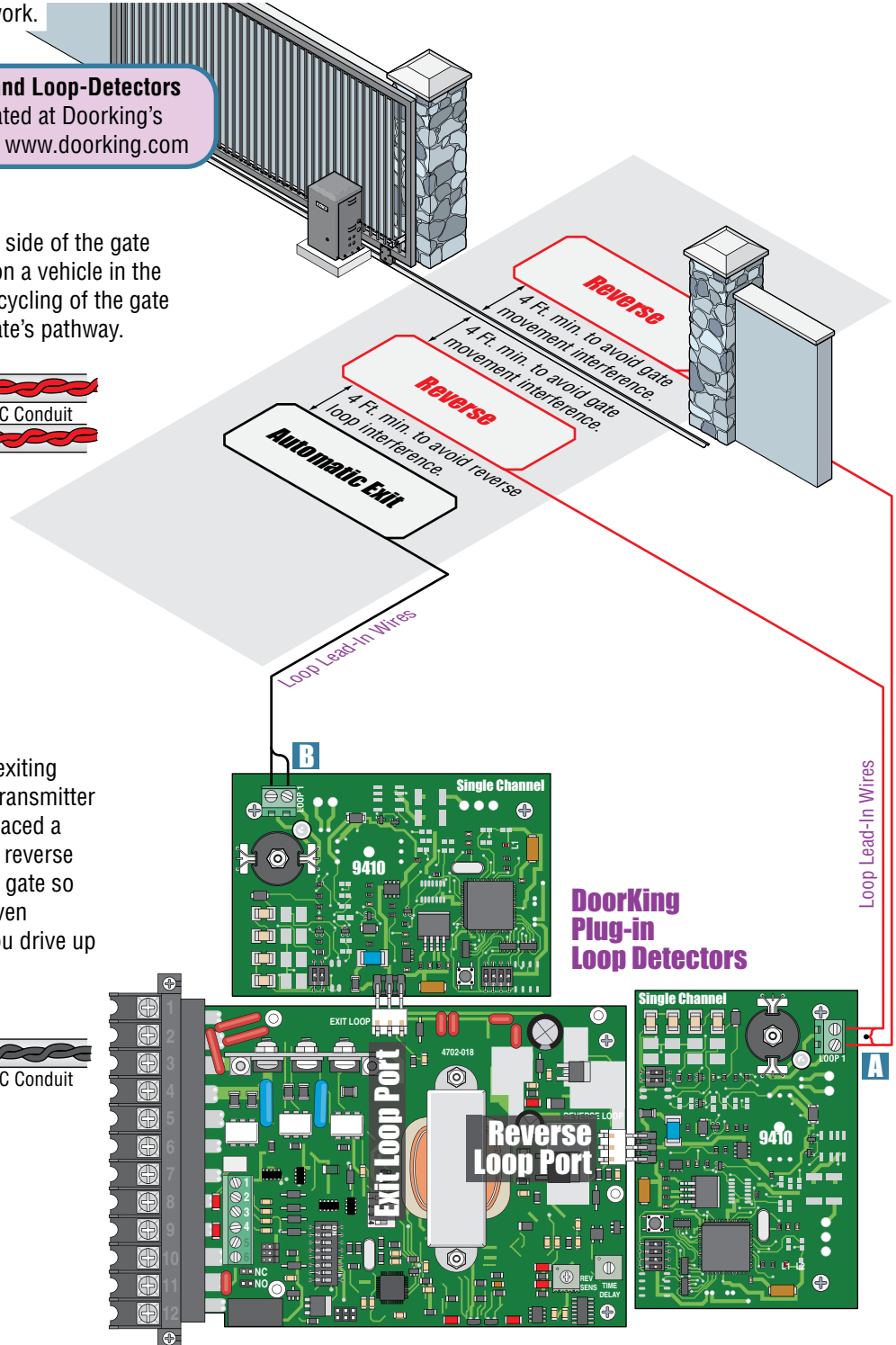
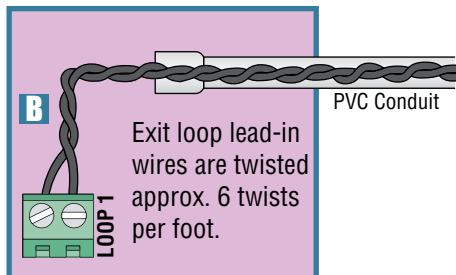

Note: Loop detector wiring is shown for DoorKing plug-in loop detector P/N 9410-010 (Single Channel) only. If other loop detectors are used, refer to the installation instructions supplied with those detectors for wiring and separate power instructions.

SECTION 5 - MAIN TERMINAL WIRING

5.1 Main Terminal Description

- When gate is closed, this input will open gate to full position.
- When gate is open and auto close timer Switch 2 is turned **ON**, input will re-set and hold timer.
- When gate is open and auto close timer Switch 2 is turned **OFF**, input will close gate.
- When gate is closing, input will reverse gate.



- This input **ONLY** functions when gate is **fully open** or in the **closing cycle**.
- When gate is open and auto close timer Switch 2 is turned **ON**, input will re-set and hold timer.
- When gate is open and auto close timer Switch 2 is turned **OFF**, input will prevent gate from closing.
- When gate is closing, input will reverse gate.



Relay activates **ONLY** when gate is in the **FULL open** position.

Relay contacts can be set for Normally Open (NO) or Normally Closed (NC) operation.
Contact rating is 1 amp maximum at 24-volts DC.

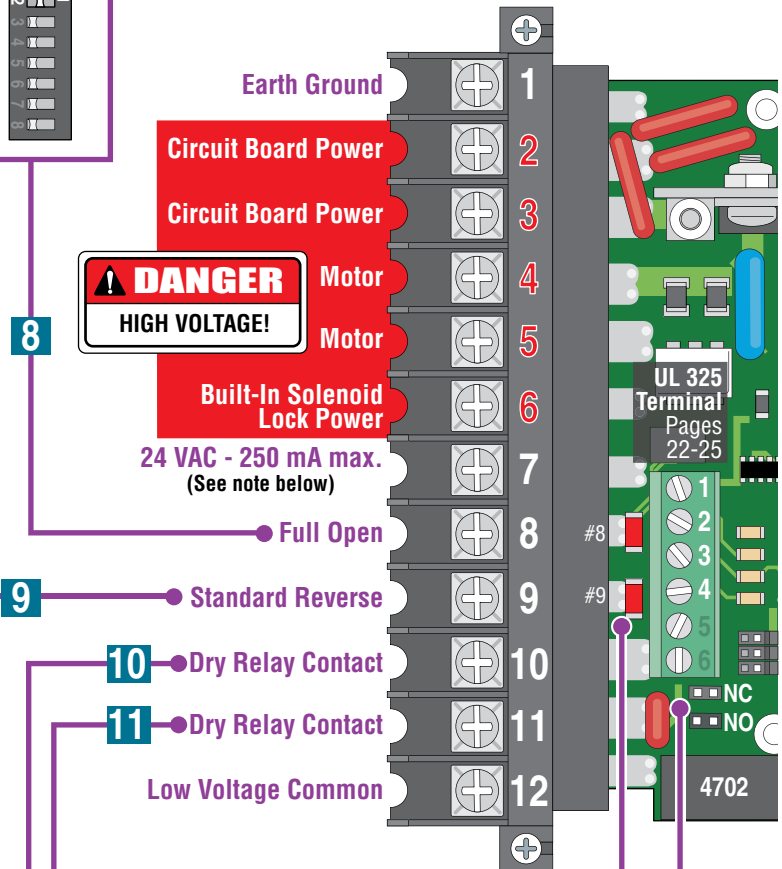
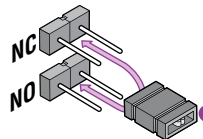

Main Terminal Input LEDs Note:
The LED that is beside the main terminal #8 and #9 wiring input will light when that terminal input gets activated.

Terminal #7 Note:
Exceeding 250 mA of power from this terminal may cause the circuit board transformer to overheat, causing intermittent problems. Use this to power the radio receiver **ONLY**.

5.2 Control Wiring for Single/Primary Operator

Important: Controls intended for user activation must be located at least six (6) feet away from any moving part of the gate and where the user is prevented from reaching over, under, around or through the gate to operate the controls. Reset buttons must be located in the line-of-sight of the gate and no further than 50 feet from the gate.

Emergency access controls only accessible by authorized personnel (e.g., fire, police, EMS) may be placed at any location in the line-of-sight of the gate.

Type of wiring to be used on ALL external devices:
A) Type CL2, CL2P, CL2R, or CL2X.
B) Other cable with equivalent or better electrical, mechanical, and flammability ratings.

Polypropylene Cover Note:
 Allows wireless signal through cover.

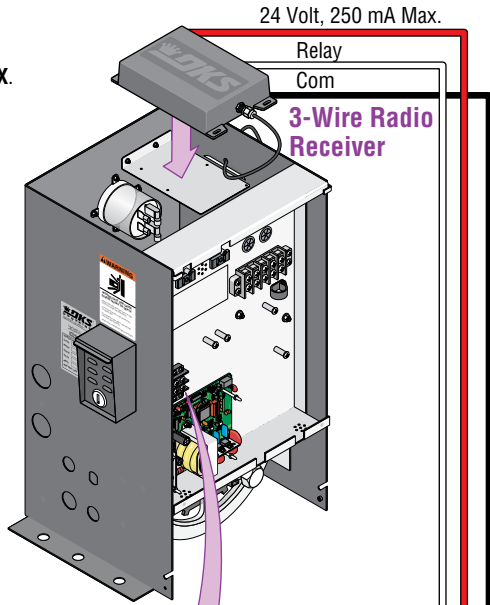
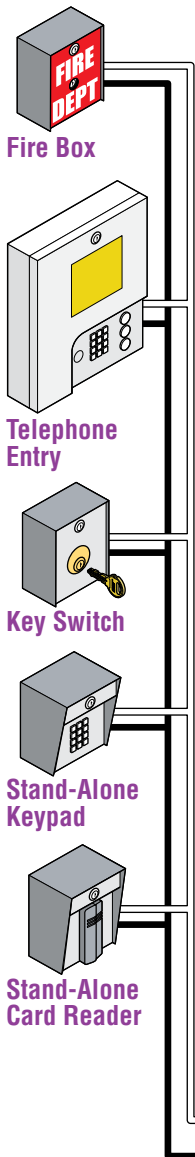

Main Terminal #7 Note:
 Exceeding 250 mA of power from this terminal may cause the circuit board transformer to overheat, causing intermittent problems.

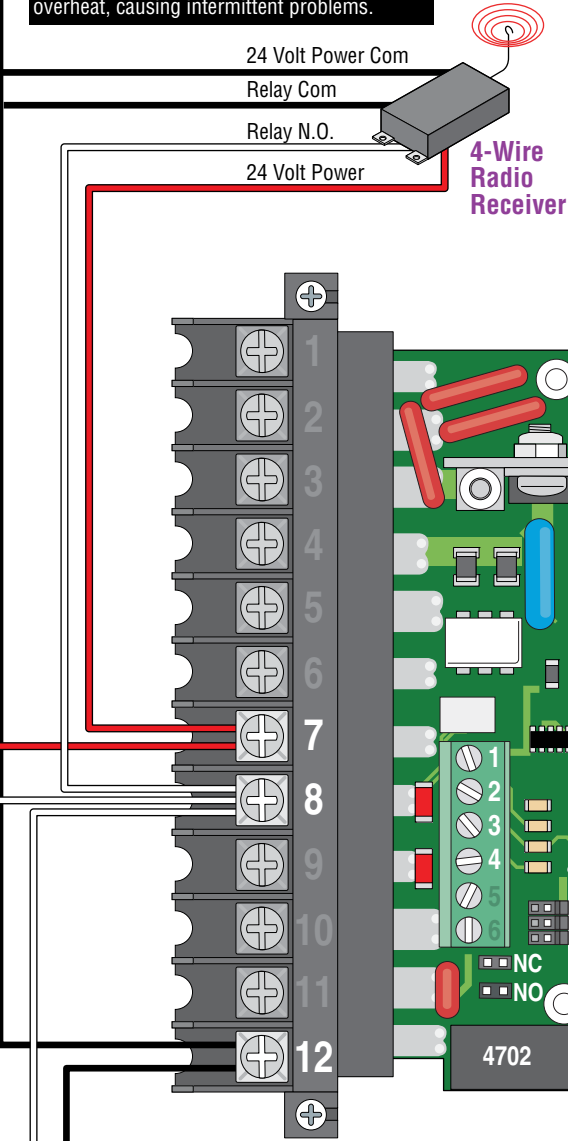

24 VAC Power Output
 Powers 24VAC control devices/
 entrapment protection devices.
 (2 amps Max)

5.3 Bi-Parting Gates Wiring - Dual Gate Operators

Entrapment Protection Devices for Bi-Parting Gates

- Separate power source for photo sensor (See page 22).

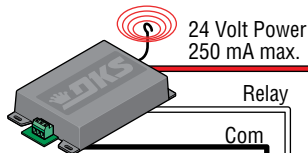
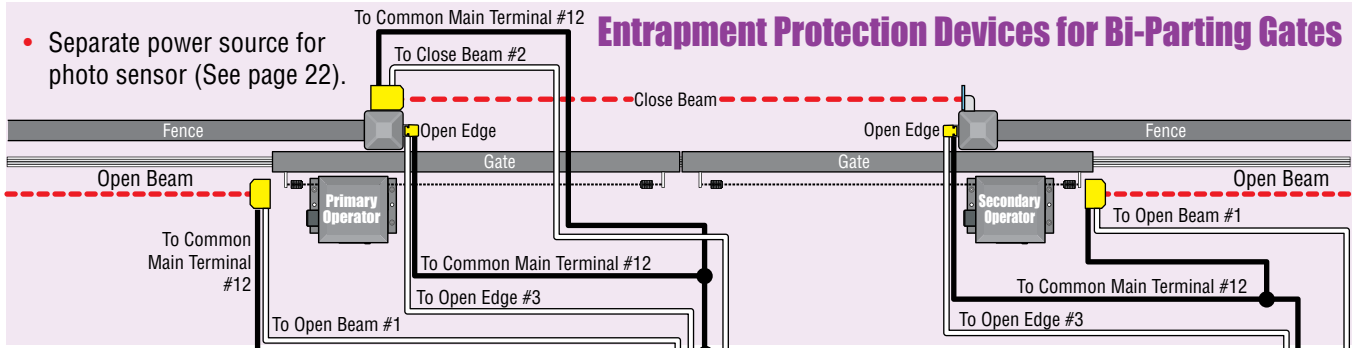

3-Wire Receiver

4-wire receiver wiring, see page 28.

Note: Connect other opening devices to primary main terminal #8 and #12 as required (See page 28). They must use a separate power source if power is required.

Main Terminal #7 Note:
Exceeding 250 mA of power from this terminal may cause the circuit board transformer to overheat, causing intermittent problems.

- Requires AC power to **each** operator.
- **Both** operator DIP-switches must be set.
- Connect all control devices, auxiliary devices and loops to the **primary operator only**.

Open Beam Note:
If **Open beam** is required for entrapment protection, #1 UL 325 terminal **MUST** be wired in parallel between primary and secondary operators.

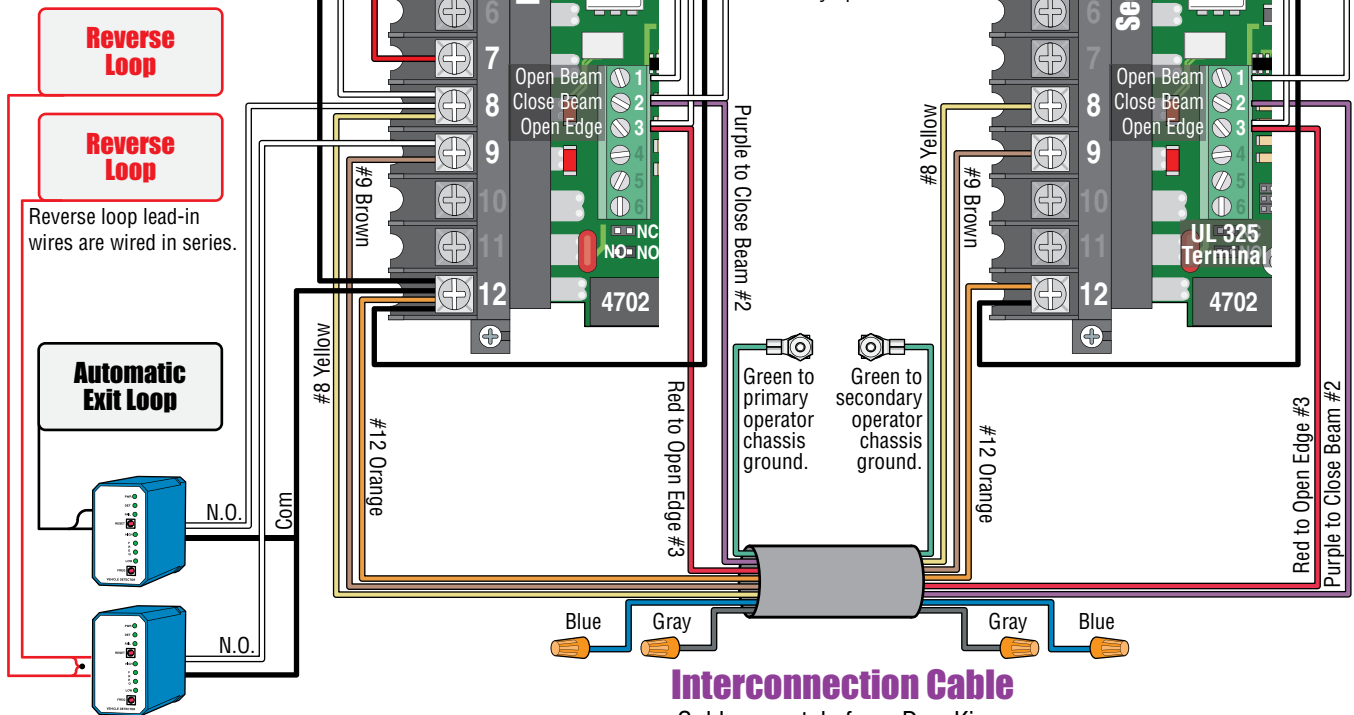

Interconnection Cable

Sold separately from DoorKing.
6 wires used (8 - 18 AWG wires total).

External Loop Detectors

DKS plug-in loop detectors **CANNOT** be used in this primary / secondary arrangement. Use external detectors that have a normally open (N.O.) relay contact. Loop detectors must use a separate power source.

Type of wiring to be used on ALL external devices:

- Type CL2, CL2P, CL2R, or CL2X.
- Other cable with **equivalent** or **better** electrical, mechanical, and flammability ratings.

SECTION 6 - OPERATING INSTRUCTIONS

IMPORTANT SAFETY INSTRUCTIONS

WARNING - To reduce the risk of injury or death:

1. READ AND FOLLOW ALL INSTRUCTIONS.
2. Never let children operate or play with gate controls. Keep the remote control away from children.
3. Always keep people and objects away from gate. **NO ONE SHOULD CROSS THE PATH OF THE MOVING GATE.**
4. Test the operator monthly. The gate **MUST** reverse on contact with a rigid object or stop or reverse when an object activates the non-contact sensors. After adjusting the force or the limit of travel, retest the gate operator. Failure to adjust and retest the gate operator properly can increase the risk of injury or death.
5. Use the emergency release only when the gate is not moving and power has been shut-off.
6. **KEEP GATES PROPERLY MAINTAINED.** Read the owner's manual. Have a qualified service person make repairs to gate hardware.
7. The entrance is for vehicles only. Pedestrians must use separate entrance.
8. **SAVE THESE INSTRUCTIONS.**

6.1 AC Power Switch and Reset Button

Unlock the power switch cover and open to access the Main Power, and the operator Reset Button.

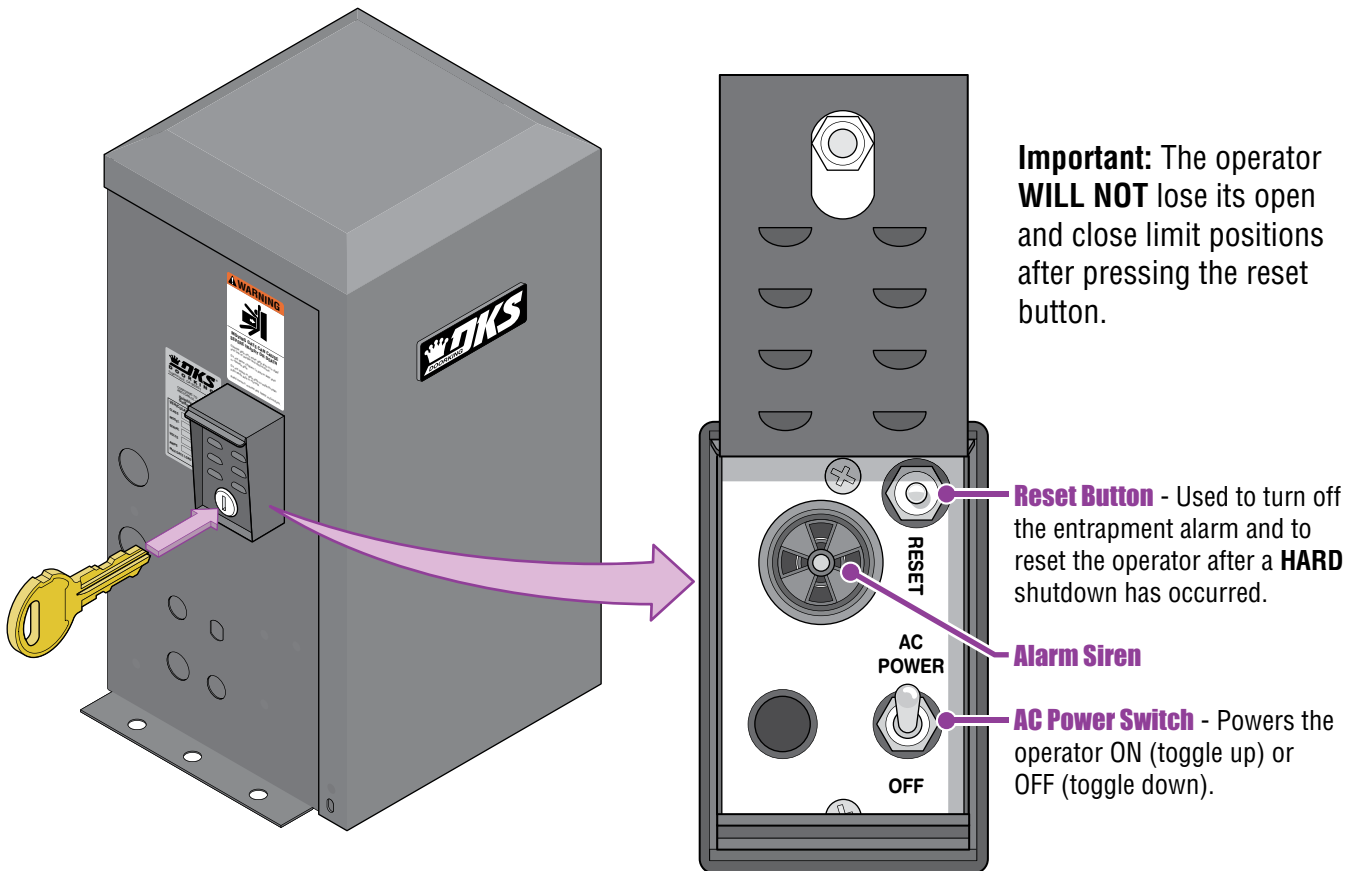

⚠ Every time the operator is powered up, the First open command will automatically run "Multiple gate cycles" that will locate and remember the gate's open and close positions (See page 20).

6.2 Shutdown Conditions

Under various entrapment conditions the operator will assume either a **soft** or **hard (alarm)** shutdown. To determine what type of reset action is required, you will need to understand how the different entrapment conditions affect the gate operator.

Soft Shutdown

This occurs in various situations where the inherent or external entrapment protection devices have been activated. In a soft shutdown condition, the operator **will not** respond to any input that was present when the entrapment protection device sensed an obstruction. If the gate stops at the open position, the operator will not respond to the automatic close timer.

- **Example 1** - A time clock keys the gate open in the morning and an entrapment protection device senses an obstruction prior to the gate reaching the full open position. If the entrapment is sensed by the inherent system, the gate will reverse and run back to the closed position. The time clock input is still present, but the gate will not re-open.

Note: In some systems, the time clock input comes from the telephone entry system relay. This same relay may also provide open commands for a card reader, MicroPLUS transmitters and the visitor telephone entry. If so, these devices will also be disabled in a soft shutdown condition.

- **Example 2** - If the gate is closing and an entrapment protection device is activated, the gate will either stop or reverse and run back to the open position, depending upon if the secondary or inherent device was activated. The automatic close timer will not close the gate.
- **Example 3** - Vehicle arrives at exit loop and gate runs towards the open position. If the inherent entrapment protection gets activated during this opening cycle, the gate reverses and runs back to the closed position. After the inherent entrapment protection is cleared, if the vehicle is still present at the exit loop, a soft shutdown condition does not occur. The exit loop input provides an immediate reset of the operator and the gate will again run to the open position.

Resetting a Soft Shutdown

In some conditions, a soft shutdown will reset as soon as the entrapment condition clears. For example, if a non-contact sensor (photo cell) is sensing an obstruction, the operator will stop the gate and assume a soft shutdown condition. When the photocell clears, the operator will return to normal operation.

When the operator is in a soft shutdown, activation of any "intended input" will reset the operator. An "intended input" includes any command, any standard safety input and any loop input. Activating any of these inputs will reset the gate. At that point the gate will return to normal operation. If the gate is open, the automatic close timer will then time out and close the gate.

Hard Shutdown (Alarm Activated)

A hard shutdown condition occurs when: (1.) The inherent entrapment protection system (Type A) gets activated TWO consecutive times before the gate completes the open or close cycle. (2.) The reversing edge (Type B2) gets activated and reverses but before the gate completes the reverse cycle the inherent entrapment protection system (Type A) gets activated.

- **Example of a Hard Shutdown** - The gate is closing and the inherent entrapment protection system senses an obstruction and causes the gate to reverse direction. As the gate begins to run in the open direction, a second obstruction is sensed prior to the gate reaching the full open position. Once the second obstruction has been sensed, the operator will stop, **the audio alarm will sound and all standard inputs are shut down** (including open commands, safety commands, loop inputs, etc.).
 - **To silence the alarm**, press the reset button or after 5 minutes, the audio alarm will shut off but will "chirp" every 5 seconds. This indicates that the operator is in a hard shutdown condition (The reset button must be pressed to reset the operator and stop the alarm "chirping").

Resetting a Hard Shutdown

The operator is in a hard shutdown condition when the audio alarm is sounding OR “chirping” every 5 seconds.

- Before resetting a hard shutdown, determine why the shutdown occurred. Inspect the gate for any obstructions along its path that could have activated the inherent entrapment sensing system. Inspect the gate and gate hardware.

The audio alarm will sound for five minutes, or until the operator’s reset button is pushed. After (5) five minutes the alarm will “chirp every 5 sec.” and the hard shutdown condition will remain in affect until the reset button is pushed.

Note: DoorKing operators have a built-in alarm reset push button mounted on the operator above the power ON-OFF toggle switch. Activating this button will return the gate operator to normal operation, but will not cycle the gate operator. A remote alarm/reset station (P/N 1404-080) can be mounted external of the gate operator provided that it is installed in the line-of-sight of the gate and gate operator.

The gate operator **WILL NOT** lose its open and close positions after resetting a hard shutdown.

Once the gate has been reset, an open or close command is needed to start the gate operator. Most activating commands will cause the gate operator to cycle to the open position. This includes activation of a key switch or open command and activation of an automatic exit loop. Activation of a close command will run the gate to the closed position.

6.3 Manual Gate Operation

This operator is equipped with one of two types of manual release systems, “**Fail-Safe**” (required by many city codes) or “**Fail-Secure**” that will allow the gate to be pushed open in the event of a power outage or equipment failure.

Caution: Never attempt to manually push open any gate with an operator attached to it until you have verified that power to the operator has been shut-off.

Fail-Safe Manual Release System (Factory Installed)

This manual release system is the most reliable and safest method for placing the gate operator in manual operation. It is the preferred method of emergency gate operation under worse case conditions by many Fire Chiefs and Building Inspectors and is **typically used in Class I and Class II applications**. This system is accessible from either side of the gate and requires **NO** keys, cranks or other tools to manually operate the gate. This prevents any delays for emergency vehicle access in the event of a power outage. The operator “Fails” (Loss of AC power) in a “Safe” (Manually operable) condition.

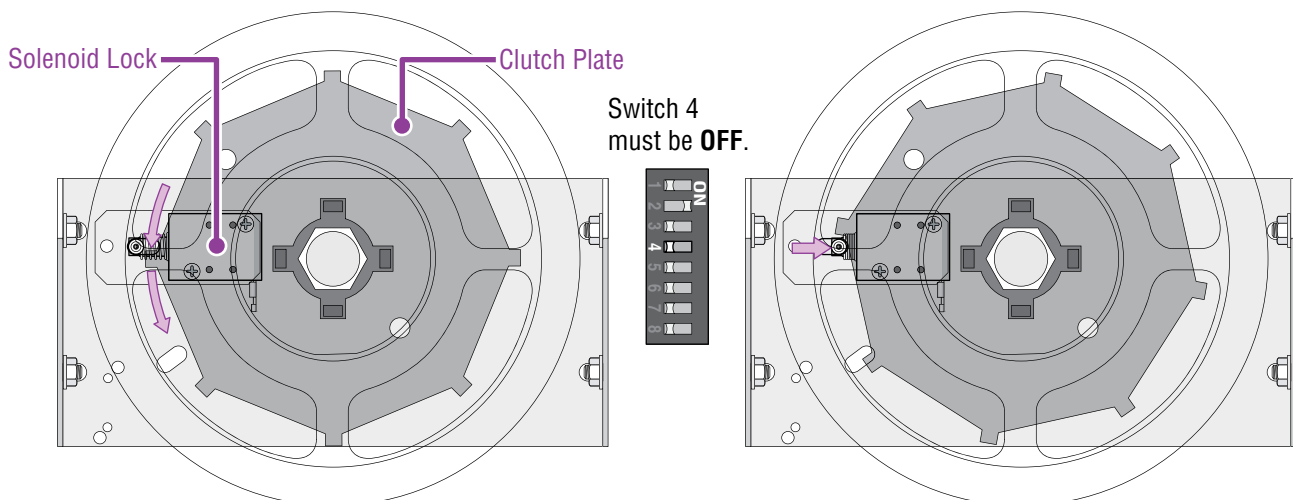

Solenoid lock does **NOT** secure the clutch plate during an AC power failure or turning AC power off. Gate can be immediately manually operated during these conditions.

Solenoid lock **WILL** retract and secure the clutch plate during normal operation **ONLY** if operator senses an **unauthorized** manual open attempt. Gate will **NOT** be allowed to move.

Fail-Secure Manual Release System (Owner Installed)

This manual release system (Installed 2600-862 Fail-Secure Manual Release Kit) allows the gate to be manually operated **ONLY** after unlocking the gate operator. Power outages or turning power off **WILL NOT** allow gate to be manually operated without physically unlocking the gate operator with the key first. This option is **typically used in Class III and Class IV applications**. The gate operator “Fails” (Loss of AC power) in a “Secure” (Manually in-operable) condition.

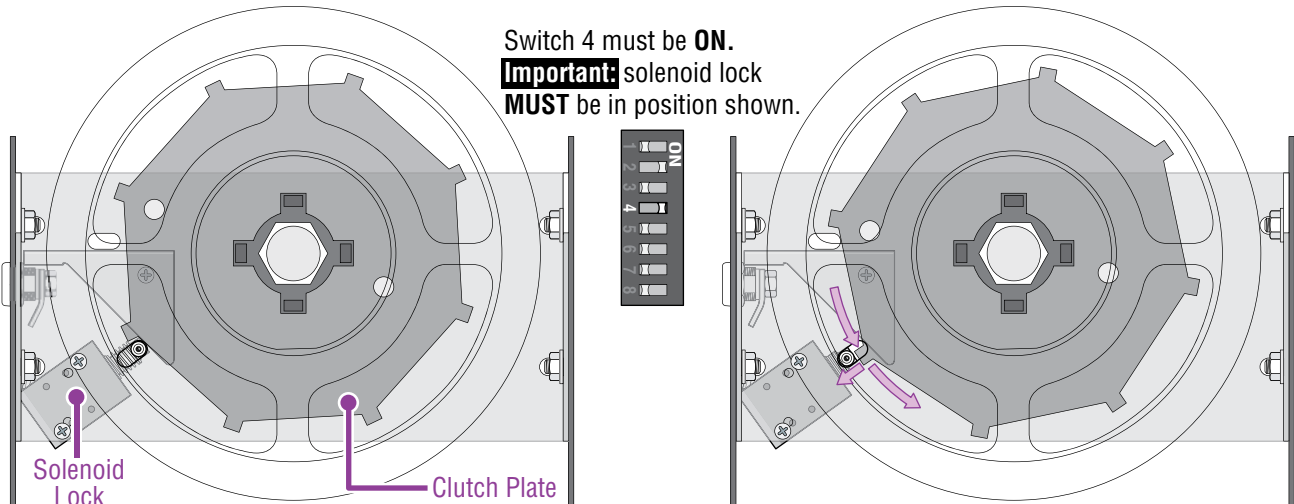

Solenoid lock does **NOT** allow the clutch plate to rotate when:

- The AC power is on but the operator is not cycling.
- The AC power is turned off.
- AC power failure.

Solenoid lock automatically retracts and allows clutch plate to rotate **ONLY** during normal gate cycling.

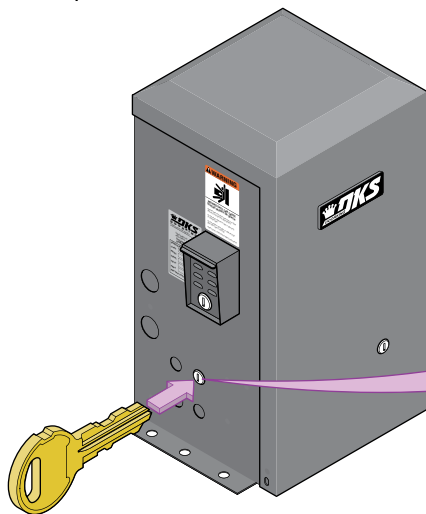

Key Release

Turning key 1/2 turn retracts solenoid lock and allows clutch plate to rotate for manual operation **with** or **without** AC power.

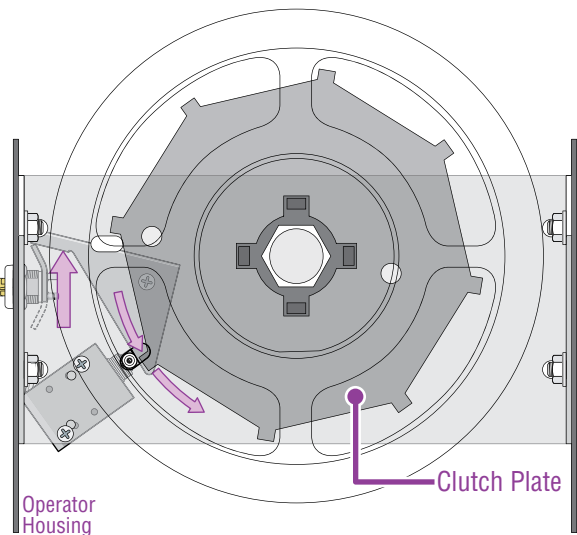

Emergency Vehicle Access Conditions

This automatic vehicular gate system is designed to allow access to emergency vehicles under different operating conditions.



1. During normal AC powered operation, emergency vehicles access the gate by a **separate** emergency access device individually installed and wired to your gate system. The type of devices that can be used in your community depends on your city codes. These devices may include (but are not limited to) Fire Department lock boxes, Click-2-Enter radio receivers, strobe light sensors, siren sensors, etc.

2. In the event of an AC power failure, the emergency vehicle access device will not function because the gate operator is un-powered. “Fail-Safe” or “Fail-Secure” release systems for the gate operator allow the gate to be manually operated during AC power failure. **ONLY** the “Fail-Safe” release system allows the gate to be manually operated **without** unlocking the operator first and has been designed that way to allow emergency personnel to immediately manually operate the gate from either side under emergency situations.

SECTION 7 - MAINTENANCE AND TROUBLESHOOTING

Inspection and service of this gate operator by a qualified technician should be performed anytime a malfunction is observed or suspected. High cycle usage may require more frequent service checks.

7.1 Maintenance

When servicing the gate operator, always check any external reversing devices (loops, photocells, etc.) for proper operation. If external reversing devices cannot be made operable, do not place this operator in service until the malfunction can be identified and corrected.

Always check the inherent reversing system when performing any maintenance. If the inherent reversing system cannot be made operable, remove this operator from service until the cause of the malfunction is identified and corrected. Keeping this operator in service when the inherent reversing system is malfunctioning creates a hazard for persons which can result in severe injury or death should they become entrapped in the gate.

When servicing this gate operator, always turn power **OFF!!**

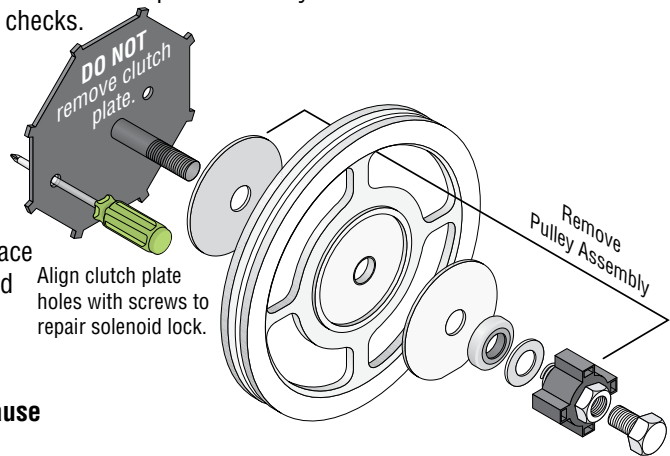

⚠ Every time the operator is powered up, the First open command will automatically run "Multiple gate cycles" that will locate and remember the gate's open and close positions (See page 20).

Operator Component	Maintenance	Monthly Interval		
		1	6	12
Warning Signs	Check that warning signs are on BOTH sides of the gate area.	✓		
Alarm	Activate the inherent reverse system by blocking the gate with a solid object. When the gate reverses, block the gate in the opposite direction prior to the limit being reached. The entrapment alarm should activate. Press the reset button to silence the alarm.	✓		
Drive Belt	Check for alignment, tightness and wear.		✓	
Chain	Check for sagging. Tighten if necessary.		✓	
Clutch	Check for proper slippage when an obstruction is encountered.	✓		
Fire Dept.	Check emergency vehicle access device for proper operation.	✓		
Gate	Inspect for damage. Check gate wheels, rollers and guides for wear and grease if necessary.		✓	
Grease	Wheels and guide rollers if necessary.		✓	
Loop(s)	Check vehicular exit and reverse loops for proper operation.	✓		
Inherent Reverse System	Check that the gate reverses on contact with an object in both the opening and closing cycles. See page 41. Adjust the reversing sensor and/or clutch if necessary.	✓		
Pulleys	Check for alignment. Check setscrews.		✓	
Manual Release	Check manual release for proper operation. See page 40.	✓		
External Reverse Devices	Check external reverse devices stop or reverse the gate when activated. See page 41.	✓		
Complete System	Complete check of gate and gate operating system.			✓

7.2 Troubleshooting

Have a good VOM meter to check voltages and continuity. A Meg-Ohm meter capable of checking up to 500 meg-ohms of resistance is necessary to properly check the integrity of the ground loops. When a malfunction occurs, isolate the problem to one of three areas: **1.** the operator, **2.** the loop system, **3.** the keying devices. **Use caution when checking high voltage terminals, motor capacitor and the motor.**

1. Check the input indicator LEDs. They should only come ON when a keying device (card reader, push button, etc.) is activated. If any of the input LEDs are ON continuously, this will cause the gate operator to hold open. Disconnect the keying devices one at a time until the LED goes OFF.
2. Check any external entrapment protection devices. Any short or malfunction in these devices can cause the gate operator to stop or to hold open.
3. A malfunction in a loop or loop detector can cause the gate operator to hold open, or to not detect a vehicle when it is present over the loop. Pull the loop detector circuit boards from the loop ports on the operator circuit board. If the malfunction persists, the problem is not with the loop system. For more information on trouble shooting loops and loop detectors, refer to your loop detector instruction sheet and to the DoorKing Loop and Loop Detector Information Manual.
4. Check to be sure that there are no shorted or open control wires from the keying devices to the gate operator. If a keying device fails to open the gate, momentarily jumper across terminals 8 and 12 on the operator circuit board. If the gate operator starts, this indicates that a problem exist with the keying device and is not with the gate operator.
5. Check the high voltage supply. A voltage drop on the supply line (usually caused by using too small supply voltage wires) will cause the operator to malfunction. Refer to the wire size chart in section 2.1, page 17.

 **Every time** the operator is powered up, the **First** open command will automatically run “**Multiple gate cycles**” that will locate and remember the gate’s open and close positions (See page 20).

Symptom	Possible Solution(s)
Operator will not run. Power LED is OFF.	<ul style="list-style-type: none"> • Check that AC power to the operator is turned ON. • Transformer may be overheated. Turn power off and allow board to cool for several minutes then retest. Check for low 115 VAC power and low voltage shorts. • Check for 115 VAC at high voltage terminal. If voltage measures 0, check the terminal strip or replace the circuit board.
Operator will not run. Power LED is ON.	<ul style="list-style-type: none"> • Insure that a minimum of one (1) external entrapment protection device is connected in EACH direction of gate travel (minimum of 2 external devices required) and the inputs are connected and enabled (UL 325 DIP-switches are turned ON). • If a photo sensor is used as a entrapment protection device, check to be sure that the beam is not blocked. • Momentarily jumper terminal 8 to terminal 12. If the input LED does not come ON, check the terminal strip or replace the circuit board. If LED does come ON, proceed to next steps. • Be sure that the chain is not too tight. A too tight chain may cause the operator to stall. • Bypass circuit board and Check Motor: Turn power switch OFF and remove the circuit board. <ol style="list-style-type: none"> 1. Place a jumper wire from terminal 3 to terminal 4. CAUTION – HIGH VOLTAGE. Turn the power switch on. The motor should run. Turn the power switch OFF and remove the jumper. 2. Place a jumper wire from terminal 3 to terminal 5. CAUTION – HIGH VOLTAGE. Turn the power switch on. The motor should run in the opposite direction. Turn the power switch off and remove the jumper. • If the motor runs in both steps above, replace the control board. If the motor does not run, or runs in only one direction, problem can be a bad motor, motor capacitor, motor resistors, wire connections from the control board to the motor or a bad control board.

Symptom	Possible Solution(s)
Operator will not run, entrapment protection input(s) LED is ON.	<ul style="list-style-type: none"> The entrapment protection device has a fault or the wiring to it is shorted.
Operator will not run, entrapment protection input(s) LED is Blinking.	<ul style="list-style-type: none"> The entrapment protection device is not connected or the wiring to it is open.
Gate opens a short distance, then stops and reverses.	<ul style="list-style-type: none"> Insure the electronic box inside operator is fully DOWN and secured properly. Check that the clutch is adjusted properly and is not slipping. Disconnect the gate from the gate operator and check that the gate slides freely without any binding. Re-adjust the reverse sensitivity. Check that the magnetic pickup transistors on control board are not obstructed by excess wires. Electrical interference from excess wires can diminish magnetic field. Check that the magnetic pickup transistors on control board are within 1/8 inch of the clear plastic protective cover above the black plastic magnetic spring assembly on the main shaft. Continue troubleshooting or replace the circuit board.
Gate opens but will not close.	<ul style="list-style-type: none"> Check the input LEDs. Any ON will hold the gate open and indicates a problem with a keying device. Check external safety devices. Any activated will hold gate open and indicates a problem with the safety device. Check the loop detectors. Any activated can hold the gate open and indicates a problem with the loop detector or ground loop. Operator may be in a “soft shutdown.” Activate any keying device to determine if operator returns to normal operation. If automatic close is desired, be sure Switch 2 is ON and set timer open from 1-23 seconds. Bypass circuit board and check motor as described on previous page.
Gate closes but will not open.	<ul style="list-style-type: none"> Operator may be in a “soft shutdown.” Check input LEDs. If any are ON, momentarily disconnect, then re-connect the wire going to the respective terminal. Operator should open. Check to be sure that the operator is running in the proper direction. Turn power OFF, and then back ON. Activate a keying device. Operator should run in the open direction. If operator runs in the close direction, turn power OFF and change direction of Switch 1. Go to above section if operator now opens but will not close. Be sure that the each LED on the control board lights when the keying device connected to the that terminal is activated. If LED does not light, momentarily place a jumper wire from terminal 12 to the input terminal being checked. If LED lights and gate opens, problem is with the keying device. If LED does not light, replace control board. Bypass circuit board and check motor as described on previous page.
Gate starts to close, then reverses to open.	<ul style="list-style-type: none"> Check that the clutch is adjusted properly and is not slipping. Re-adjust the reverse sensitivity. Disconnect the gate from the gate operator and check that the gate slides freely without any binding. Check the loop detector LEDs and input LEDs. Any that flash ON will cause the gate to reverse. Check the Magnetic Sensor LEDs on the circuit board. If either LED is not blinking as the operator is running, check that the magnetic pickup transistors are within 1/8 inch of the protective plastic cover above the magnet assembly on the main shaft. Continue troubleshooting or replace the circuit board.
Gate closes then re-opens.	<ul style="list-style-type: none"> Check for any input or loop detector LED's that are ON. Check that the operator is running in the proper direction (see “gate closes but will not open”). Turn power off, then back on to run multiple gate cycles to reset operator open and close positions.
Alarm is sounding. Operator will not run.	<ul style="list-style-type: none"> Operator is in a “hard shutdown” condition. Reset button must be pushed to return operator to normal operation, see Section 6.2 Shutdown Conditions, pages 31-32.
Alarm chirps once every 5 seconds. Operator will not run.	<ul style="list-style-type: none"> Operator has been in a “hard shutdown” condition in excess of 5 minutes. Reset button must be pushed to return operator to normal operation, see Section 6.2 Shutdown Conditions, pages 31-32.
Operator has intermittent functionality problems that vary.	<ul style="list-style-type: none"> The main terminal #7 250 mA power has been exceeded. Check total amp draw of connected device(s).

7.3 Accessory Items

UL 325 Monitored Entrapment Protection Devices available for model 9050 slide gate operator.

Type B2 Contact Sensors (Reversing Edge)

DoorKing 8080 Series Sensing Edges
Miller Edge Sensing Edges - all models with a T2 (resistive) termination.
Miller Edge wireless monitored transmitter/receiver kit model RB-G-K10
ASO GMBH Sentir GF Series sensing edges

Type B1 Non-contact Sensors (Photo Cell)

DoorKing Model 8080-057 Retro-Reflective Photocell
Miller Edge Reflective-Guard Model RG
Miller Edge Prime-Guard Model PG
EMX Industries Model IRB-MON
EMX Industries Model IRB-RET
Omron Model E3K-R10K4
Seco-Larm Model E-936-S45RRGQ
Seco-Larm Model E-960-D90GQ

Monitored Expansion Kit

Miller Edge Multi-Input Module Model MIM-62

Accessory items available for the model 9050 slide gate operator.

Plug-In Loop Detector - Detectors plug directly into ports on circuit board simplifying wiring.

Single channel detector - P/N 9410-010
Dual channel detector - P/N 9409-010
Single channel detector with aux relay - P/N 9411-010
Single channel low power draw detector - P/N 9416-010
Dual channel low power draw detector - P/N 9415-010

External Loop Detector

Reno A&E 12/24 VDC or 24 VAC - 9402-045
Reno A&E 120 VAC - 9402-047
Carlo Gavazzi 24 VAC/VDC - 9402-044
Diablo 10-30 VAC/VDC low power draw - 9402-050

Loop Wire - 18 AWG loop wire with XLPE insulation is ideal for ground loops. Available in 500 and 1000 foot rolls. Red, blue or black insulation.

Pre-Fab Loops - Prefabricated ground loops. 24-foot circumference with 50-foot lead-in. Available in yellow, red or blue jackets. Not for use in asphalt roadways.

Loop Test Meter - Meg-ohm meter checks the integrity of ground loops. P/N 9401-045

Interconnect Cable - Interconnect wire cable contains all the necessary wires to interconnect primary / secondary operators.

Cable length: 30 ft. - P/N 2600-755 40 ft. - P/N 2600-756 50 ft. - P/N 2600-757

115 VAC Heater with Fan Assembly Kit - Thermostatically controlled heater and fan for cold environments.

For 115 VAC input power ONLY. P/N 1601-154

Time Clock - 7 day clock can be used to automatically open gate at pre-set time and days. Compact clock fits inside the operator.

7 day clock - P/N 2600-791

V-Wheels - 4 inch and 6 inch. UHMW or Steel. Roller bearings or sleeve bearings. Single or tandem wheel configurations.

Endless Idler Assembly with Safety Cover - Use when gate operator chain needs 180° return. P/N 2600-818

Guide Rollers with Safety Covers - A variety of sizes to support slide gates.

Gate End Retainer - Fits on top of end post and helps stabilize the end of the gate in the open or closed position (End post not provided).

P/N 1204-004

Base Plate for 9050 - Required for post mount installation. P/N 2600-418

Base Plate Stop Brackets for 9050 - Required for post mount installation when using chain stops. P/N 2600-970

Additional #40 Chain - 20 ft. per box. P/N 2600-442

Fail-Secure Manual Release Kit - Changes the Fail-Safe manual release to a Fail-Secure manual release. P/N 2600-862

Surge Devices - High and low voltage surge suppressors help prevent circuit board failure caused by lightning strikes and power surges.

High Voltage - P/N 1879-010 Low Voltage - P/N 1878-010

Speed Bumps - Prefabricated six-foot speed bump reduces traffic speed through gate system. P/N 1610-150

Model 9050 1/2 HP 115 VAC

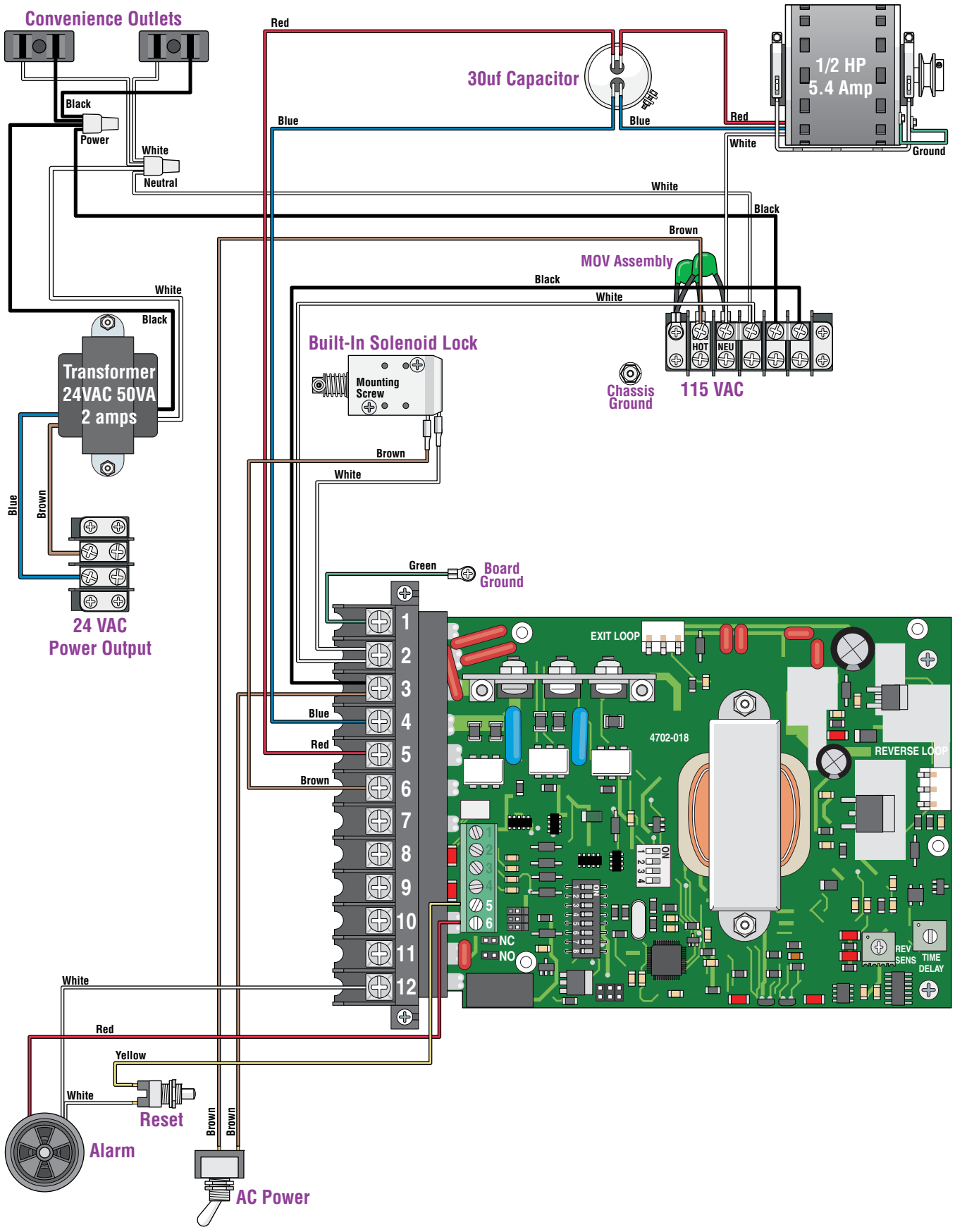

SECTION 8 - OWNER OF THE GATE OPERATOR

8.1 Alarm Sounding OR “Chirping” and Gate WILL NOT Operate

Operator is in a HARD Shutdown Condition: The alarm will sound for (5) five minutes. After five minutes the alarm will start “Chirping” every 5 seconds and continue “Chirping” until operator gets reset.



A KEY has been supplied that will unlock the power switch cover on this gate operator.

Note: The owner of the gate operator is responsible for the KEY availability.

When Alarm is Sounding OR “Chirping”

ALWAYS CHECK THE ENTIRE GATE AREA FOR ANY OBSTRUCTIONS OR DAMAGE FIRST.



- If a Fire Dept Access Device has been activated by **emergency personnel**, then operator can be **reset** and put back into normal operation again. Alarm will **always** sound when this access device gets activated.
- If the cause of the alarm **CAN** be identified and **CORRECTED**, then operator can be **reset** and put back into normal operation again.
- If the cause of the alarm **cannot be corrected**, shut-off power and **DO NOT** place this operator back into service until the malfunction can be identified and **CORRECTED**.

IMPORTANT: Putting this gate operator back into service **WITHOUT CORRECTING** the cause of the alarm could result in severe injury or DEATH!

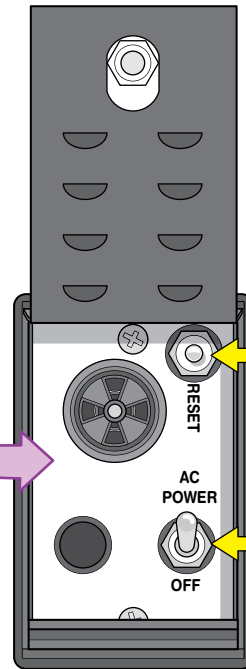
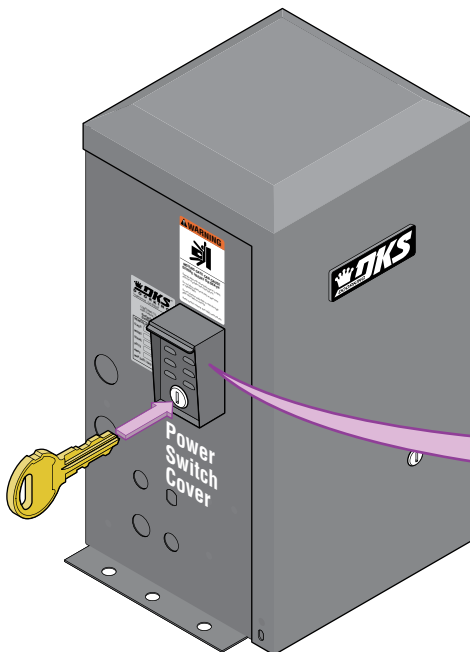

Reset Operator:

UNLOCK the power switch cover with **KEY**.
Press **RESET Button OR**
Cycle Power Switch OFF & ON.

This will reset the gate operator and allow normal gate operation again.

Press RESET Button

OR

Cycle Power Switch

Operator HARD Shutdown Condition occurs when:



1. Fire Department (Emergency Access) input has been activated by Police, Fire Department, EMT, Ambulance etc.
2. The inherent entrapment protection system (Type A) gets activated **TWO** consecutive times before the gate completes the open cycle **OR** the close cycle.
3. The reversing edge contact sensor (Type B2) gets activated and reverses, but before the gate completes the reverse cycle the inherent entrapment protection system (Type A) gets activated.

Please read **SECTION 6 - OPERATING INSTRUCTIONS** for more information about operating this gate operator.

8.2 Manual Gate Operation

Caution: NEVER attempt to manually operate the gate until you have VERIFIED that power to the gate operator has been SHUT-OFF!

Please read **SECTION 6 - OPERATING INSTRUCTIONS** for more information about operating this gate operator.

Factory Equipped FAIL-SAFE Manual Operation

Gate can be **IMMEDIATELY** manually operated (pushed open) during a power outage. **NO** Key is required.

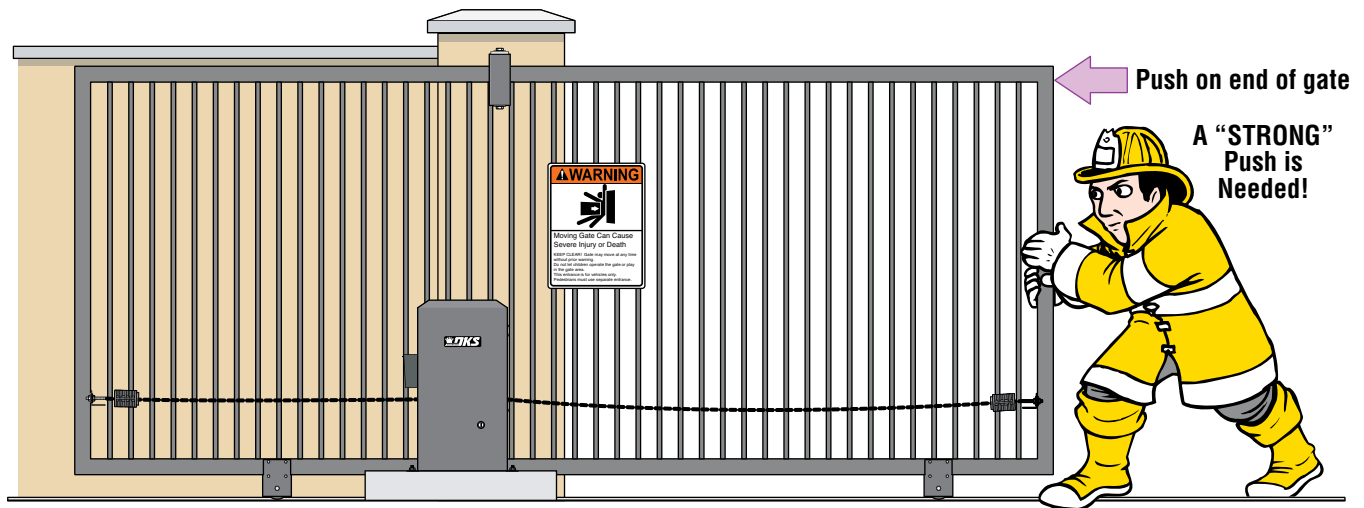

Optional Owner Installed FAIL-SECURE Manual Operation

Gate **CANNOT** be manually PUSHED open until FAIL-SECURE Lock has been UNLOCKED.

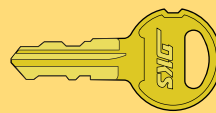
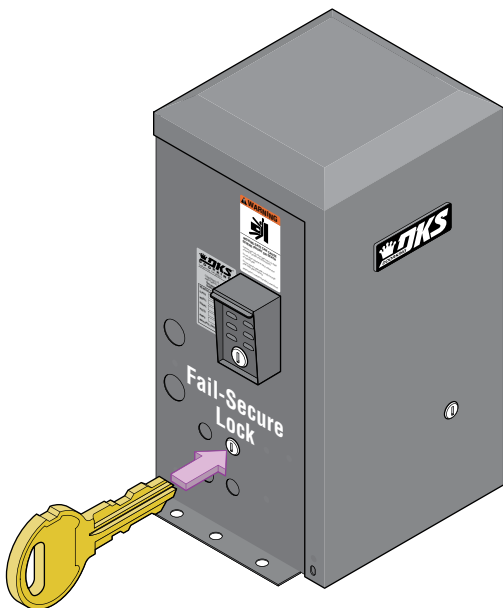

A KEY is supplied with the Optional Fail-Secure Kit that will unlock the Fail-Secure lock and release the gate.

Turn **Key** 1/2 turn (180°).
Manually operate gate
(Push Open).

Manual operation **with** or
without AC power.

Note: The **owner** of the gate operator is responsible for the **KEY** availability.

Note: If gate operator does **NOT** have a fail-secure lock, then the operator is a FAIL-SAFE operator (see above).

8.3 Gate Operator's Monthly Checkup

Caution: Make SURE gate area is clear BEFORE testing the gate operator!

DO NOT repair or adjust gate systems yourself. Contact a trained gate systems technician with any questions or to make any repairs or adjustments. If you feel uncomfortable performing any of these inspections or testing, a qualified service technician will perform the visual inspections and testing for you. You can find a trained service technician at DoorKing's "Dealer Locator" at www.doorking.com

Visual Inspection

Visually inspect the rollers, fasteners, brackets and other gate hardware for proper alignment, proper tightness, and signs of damage, breakage, looseness, rust or wear. Moving parts should be lubricated and should not be squeaking. Visually inspect wiring for fraying or exposure. If a malfunction is found, contact a trained service technician to make adjustments or repairs.

Test Built-In Reversing Sensor

Begin with the gate in the fully **OPEN** position. Stand just outside the path of the gate and close the gate (typically auto-timer will time-out and close gate automatically). As the gate is **closing**, firmly press a solid object against the end of the gate frame in the direction opposing the travel of the gate. The gate should **stop** within 2 sec. and **reverse** to the **OPEN** position. Another input command is needed before the gate will reset and close again. Repeat this test while **opening** the gate. Start from the fully **CLOSED** position. While **opening**, gate should **stop** and **reverse** to the **CLOSE** position. If gate does **NOT** respond like it should in **either** direction of gate travel, contact a trained service technician to make adjustments or repairs.

Test Photo Sensors

If the gate has a photo sensing device protecting the path of a **closing gate**, perform the following test. Begin with the gate in the fully **OPEN** position. Stand just outside the path of the gate and close the gate (typically auto-timer will time-out and close gate automatically). Pass an object across the path of the closing photo sensing beam. The gate should **stop** within 2 sec. and **reverse** to the **OPEN** position. Typically the auto-timer times out and gate closes again.

If the gate has a photo sensing device protecting the path of a **opening gate**, start from the fully **CLOSED** position. **OPEN** gate. Pass an object across the path of the opening photo sensing beam. The gate should **stop**, the gate will resume opening when the beam is clear. If gate does **NOT** respond like it should in **either** direction of gate travel, contact a trained service technician to make adjustments or repairs.

Test Reversing Edges

If the gate has a reversing edge(s) protecting the path of a **closing gate**, perform the following test. Begin with the gate in the fully **OPEN** position. Stand just outside the path of the gate and close the gate. As the gate is closing, firmly press a solid object against the reversing edge in the direction opposing the travel of the gate. The gate should **stop** within 2 sec. and **reverse** to the **OPEN** position (typically auto-timer will time-out and close gate automatically). If the gate encounters **another** obstruction before it is closed, the gate will **stop** and reverse to the **OPEN** position **again**. A input command is needed before the gate will reset and close again, auto-timer will **NOT** close gate (Typically, press your remote button for input command). If the gate has a reversing edge(s) protecting the path of a **opening gate**, starting from the fully **CLOSED** position. Stand just outside the path of the gate and open the gate. **OPEN** gate. As the gate is opening, firmly press a solid object against the reversing edge in the direction opposing the travel of the gate. gate should **stop** and **reverse** to the **CLOSE** position. If gate does **NOT** respond like it should in **either** direction of gate travel, contact a trained service technician to make adjustments or repairs.

Note: This gate operator uses high levels of force to move the gate and most people underestimate the power of these systems and do not realize the potential hazards associated with this system if **NOT** maintained properly.

Scheduled maintenance visits are offered by most qualified service technicians to MAINTAIN your gate operator system.

8.4 New Installation Checklist for Installer and Property Owner

Instructions: Check the space next to each item (“✓”) to indicate that it has been addressed by installer **AND** property owner. If it is not applicable, enter N/A. Please note that the checklist is intended to be a summary of many **important** automated vehicular gate aspects, **But may not inclusively identify all potential hazards of every specific gate system installation.**

Each item listed and checked has been examined by the Installer and is CLEARLY understood by the Property Owner.

Installer	Property Owner	Description
		The operator is installed on a gate used for vehicles only. Verify that separate pedestrian access is provided or available, and the access is such that pedestrians cannot come in contact with the moving vehicular access gate during its entire length of travel.
		Gate/Hardware: Insure that there is a means to prevent the gate from falling over in the event of a roller or hinge failure. Insure the gate has physical limit stops and that gravity will not initiate motion of the gate. Insure that all rollers are guarded or covered to eliminate the possibility of a finger being inserted between the roller and gate.
		Slide Gate: Insure that the maximum opening in the gate and in that portion of the adjacent fence that the gate covers when the gate is in the open position is such that a 2 ¼" sphere cannot pass through the openings up to 72 inches above the ground or to the top of the gate, whichever is less. If the gate and adjacent fence do not meet this requirement, wire mesh (or other means) must be added to meet this requirement before placing the gate system in operation. Insure that any gaps between the slide gate and stationary posts/pilasters is less than 2 1/4" and that these areas are protected with an entrapment protection device.
		The gate operator system is in compliance with the entrapment protection requirements of UL 325. Identify all potential entrapment zones and ensure they are protected. Potential pinch areas have been guarded so as to be inaccessible OR have a contact (reverse edge) and/or non-contact (photocell) obstruction sensing devices installed. Verify that the system has in place external entrapment protection, independent from the inherent entrapment protection. Edge sensors or photocells are typical, other means are possible. For more information see your specific installation/owners manual for entrapment protection installation and locations.
		The installer has properly adjusted the inherent entrapment protection feature on the gate operator, and has tested the gate to make sure that the gate stops and reverses a short distance upon striking an immovable object.
		Check that placement of user operational controls are six (6) or more feet away from the gate. If any operational control is closer than six (6) feet to the gate, DO NOT place the automated vehicular gate into service.
		Warning signs are to be permanently installed in the area of the gate in such a manner that at least one warning sign is visible by persons located on each side of the gate, for both the secure and unsecure sides of the gate.
		The installer has instructed the property owner in the proper use of the gate operator and has reviewed the operational functions, obstruction-sensing devices, alarm, and reset as outlined in your specific installation/owners manual.
		The installer has instructed the property owner in the proper use of the operator's manual release feature as outlined in your specific installation/owners manual.
		The installer has reviewed all safety instructions with the property owner , including the need to never let children operate or play with gate controls, to keep the remote control away from children, and to always keep people and objects away from the gate.
		The installer has explained to the property owner that a regular maintenance schedule for both the gate and the gate operator is recommended, including regular testing of entrapment protection as outlined in the manufacturer's instructions.
		The installer has left the installation/owners manual with the property owner for future reference.

Alarm Sounding OR "Chirping" and Gate WILL NOT Operate

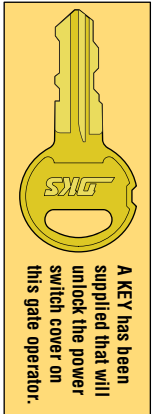

To obtain key to unlock gate operator contact:

Name _____

Phone # _____

Operator is in a HARD Shutdown Condition: The alarm will sound for (5) five minutes. After five minutes the alarm will start "Chirping" every 5 seconds and continue "Chirping" until operator gets reset.

When Alarm is Sounding OR "Chirping"

ALWAYS CHECK THE ENTIRE GATE AREA FOR ANY OBSTRUCTIONS OR DAMAGE FIRST!

- If a Fire Dept. Access Device has been activated by emergency personnel, then operator can be reset and put back into normal operation again. Alarm will always sound when this access device gets activated.
- If the cause of the alarm **CAN** be identified and **CORRECTED**, then operator can be reset and put back into normal operation again.
- If the cause of the alarm **cannot be corrected**, shut-off power and **DO NOT** place this operator back into service until the malfunction can be identified and **CORRECTED**.

IMPORTANT! Putting this gate operator back into service **WITHOUT CORRECTING** the cause of the alarm could result in severe injury or DEATH!

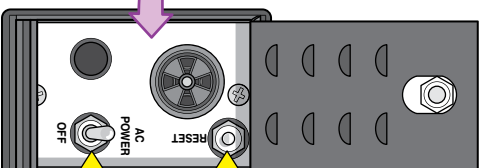
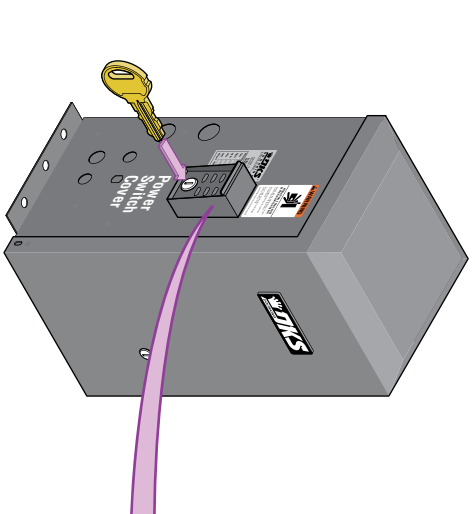

Reset Operator:

UNLOCK the power switch cover with KEY. Press **RESET** Button OR Cycle Power Switch **OFF & ON**. This will reset the gate operator and allow normal gate operation again.

Press RESET Button

OR

Cycle Power Switch

Operator HARD Shutdown Condition occurs when:

1. Fire Department (Emergency Access) input has been activated by Police, Fire Department, EMT, Ambulance etc.
2. The inherent entrapment protection system (Type A) gets activated TWD consecutive times before the gate completes the open cycle OR the close cycle.
3. The reversing edge contact sensor (Type B2) gets activated and reverses, but before the gate completes the reverse cycle the inherent entrapment protection system (Type A) gets activated.

Please read **SECTION 6 - OPERATING INSTRUCTIONS** for more information about operating this gate operator.

www.doorking.com to get a PDF of this manual - Remove this page OR print this page in color, fold and laminate - Place at the gate operator

Manual Gate Operation

Caution: NEVER attempt to manually operate the gate until you have VERIFIED that power to the gate operator has been SHUT-OFF!

Please read **SECTION 6 - OPERATING INSTRUCTIONS** for more information about operating this gate operator.

Factory Equipped FAIL-SAFE Manual Operation

Gate can be IMMEDIATELY manually operated (pushed open) during a power outage. NO Key is required.

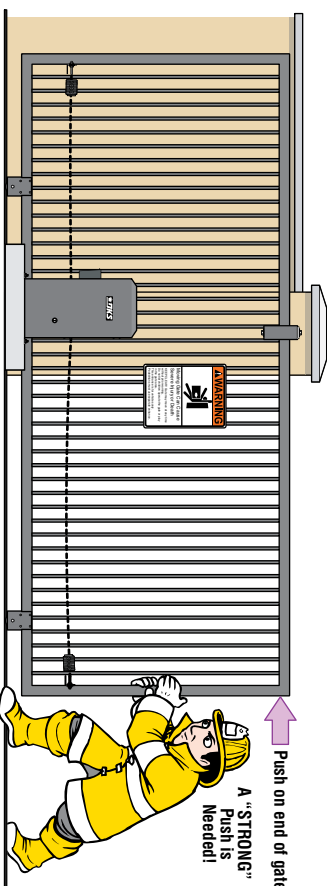

Optional Owner Installed FAIL-SECURE Manual Operation

Gate CANNOT be manually PUSHED open until FAIL-SECURE lock has been UNLOCKED.



To obtain key to unlock gate operator contact:

Name _____

Phone # _____

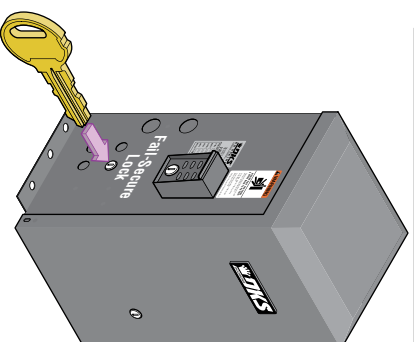

Turn **Key** 1/2 turn (180°). Manually operate gate (Push Open) Manual operation with or without AC power.

Note: If gate operator does NOT have a fail-secure lock, then the operator is a FAIL-SAFE operator (see above).

Place at the gate operator

Installation/Owner's Manual

Model 9050

Vehicular Slide Gate Operator

Use this manual for circuit board 4702-018 Revision A or higher.

9050-065-T-11-25

Entrapment Protection must be provided for the gate system where the risk of entrapment or obstruction exists. The operator will NOT run without one or more monitored type B1 or B2 entrapment protection devices in EACH direction of gate travel.

UL 325 August 2018 Standard



THIS PRODUCT IS TO BE INSTALLED AND SERVICED BY A TRAINED GATE/DOOR SYSTEMS TECHNICIAN ONLY.
Visit www.doorking.com/dealer-locator to find a professional installing and servicing dealer in your area.

www.doorking.com

DoorKing, Inc.
120 S. Glasgow Avenue
Inglewood, California 90301
U.S.A.

Phone: 310-645-0023
Fax: 310-641-1586